

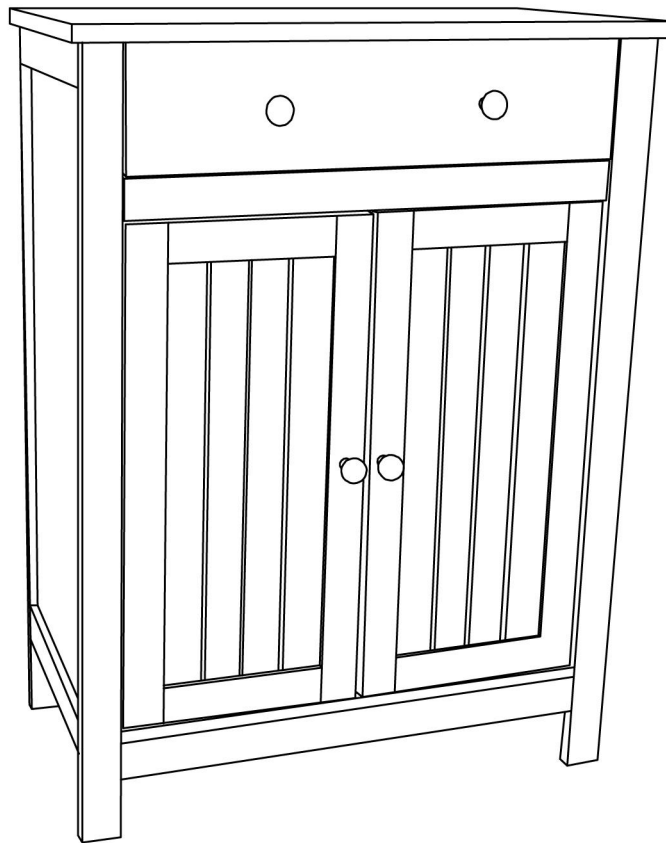

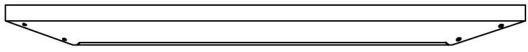

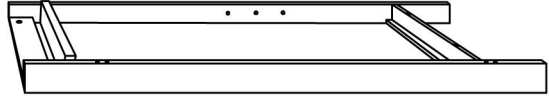

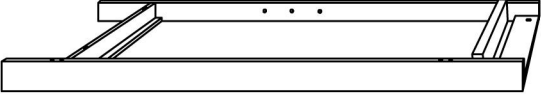
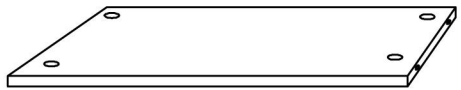

ASSEMBLY INSTRUCTION

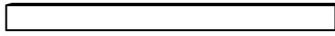
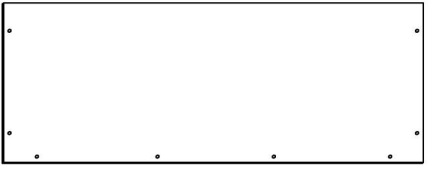

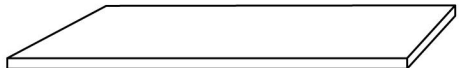

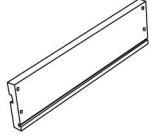

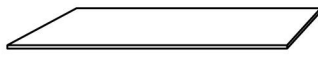
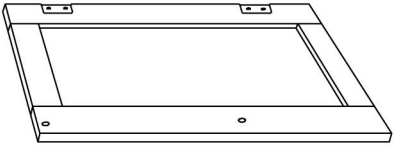
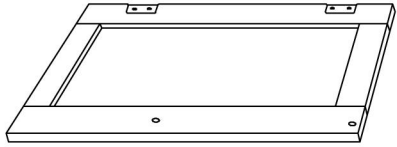

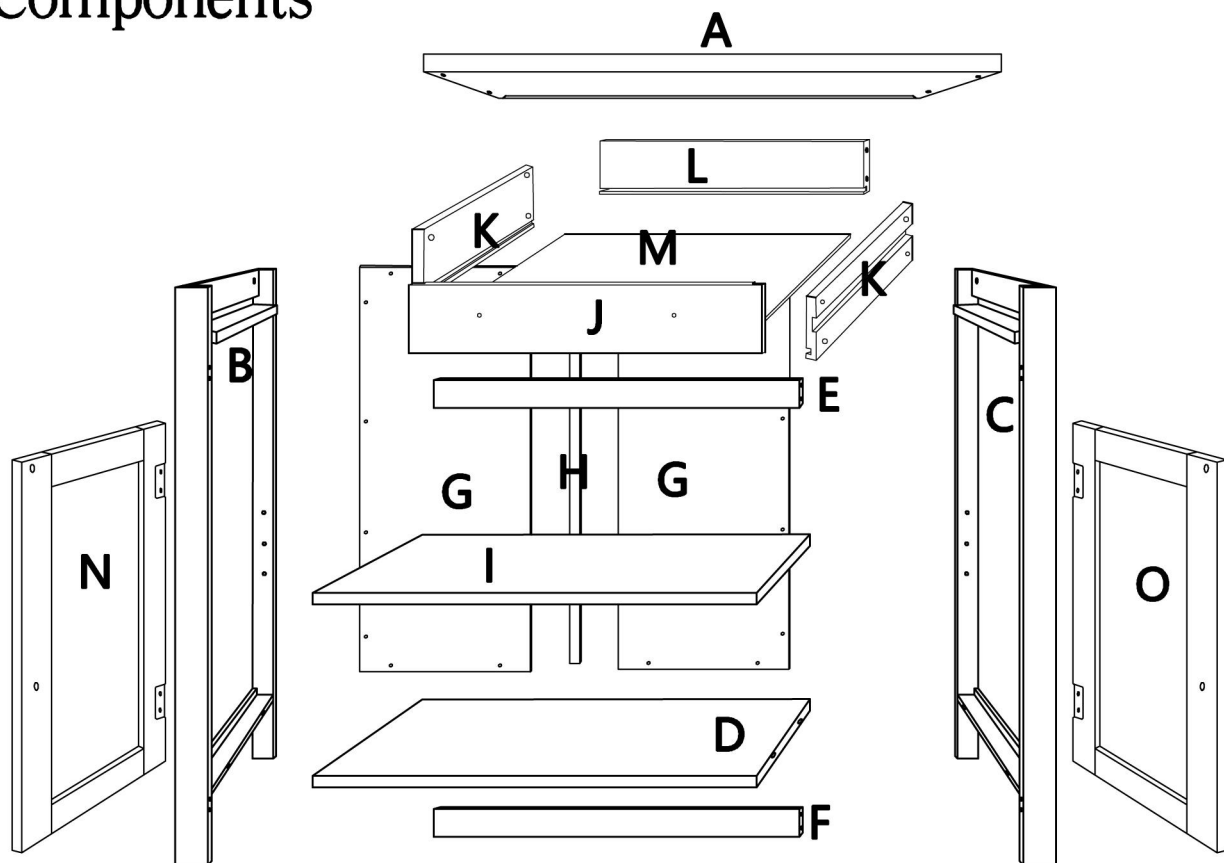

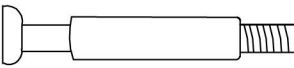

Components

A  × 1PC	B  × 1PC	
C  × 1PC	D  × 1PC	
E  × 1PC	F  × 1PC	
G  × 2PCS	H  × 1PC	
I  × 1PC	J  × 1PC	
K  × 2PCS	L  × 1PC	M  × 1PC
N  × 1PC	O  × 1PC	

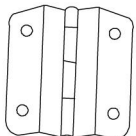



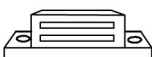
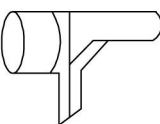

Components

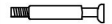

Hardware

1  ×6	2  ×8	3  ×6	4 3×12mm  ×20
5  ×4	6 4×18mm  ×4	7  ×4	8  ×2
9  ×1	10  ×4	11 2×10mm  ×16	12 4×30mm  ×8

STEP 1

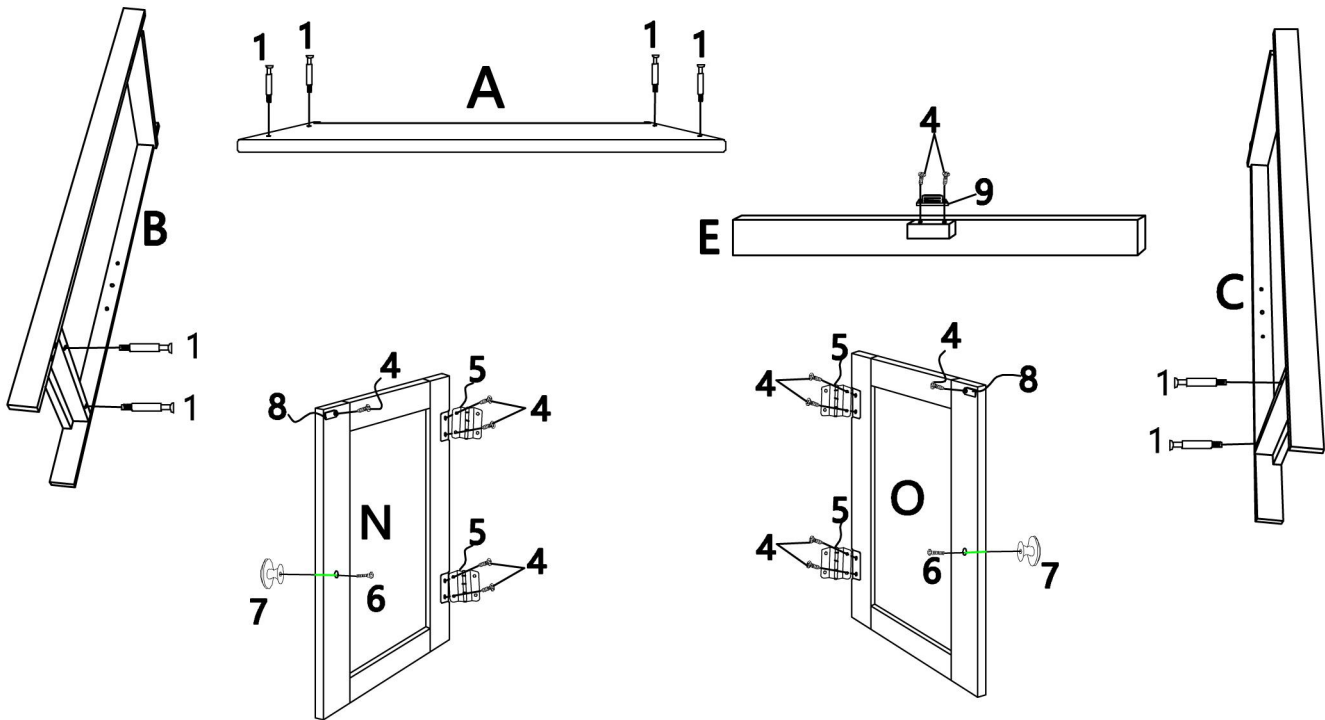

	1X8		4X12		5X4		6X2
	7X2		8X2		9X1		





STEP 2

	3X2
---	-----

STEP 3

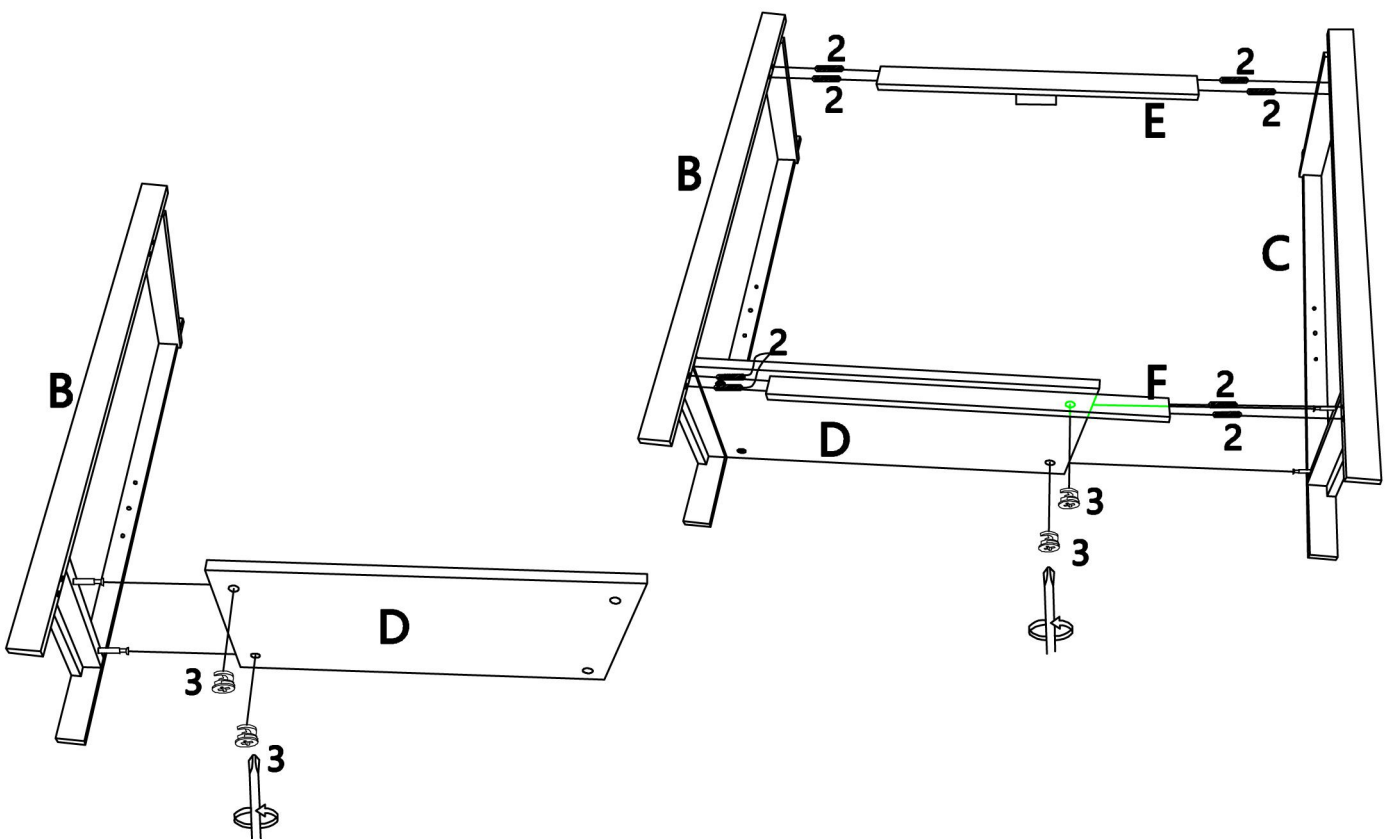
	2X8		3X2
--	-----	---	-----



STEP 4  **3X4**

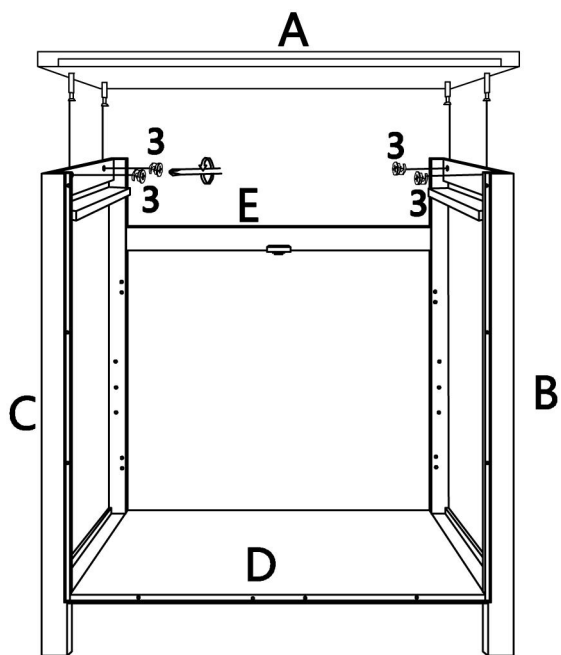

STEP 5

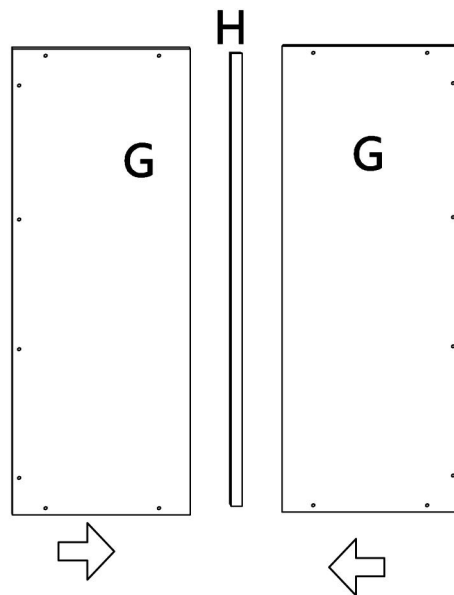

STEP 6  **11X16**

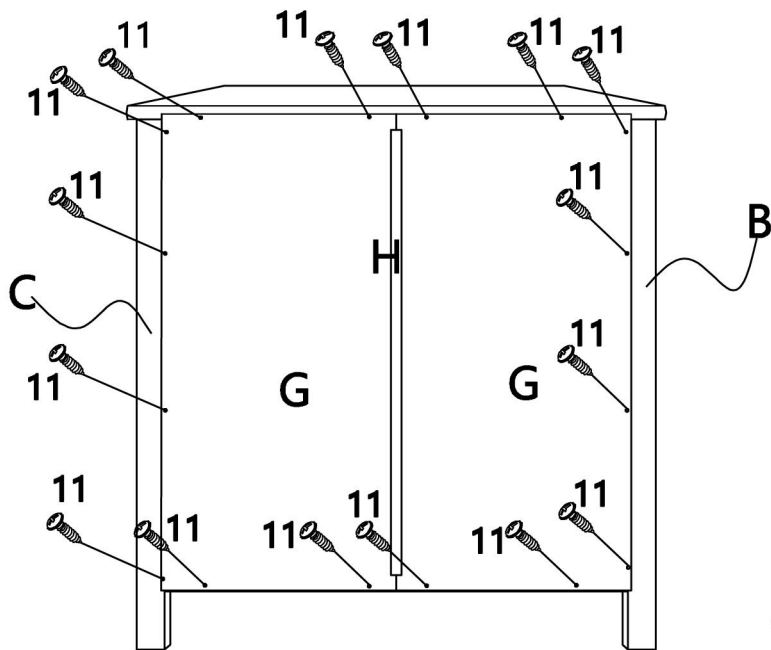

STEP 7  **12X4**

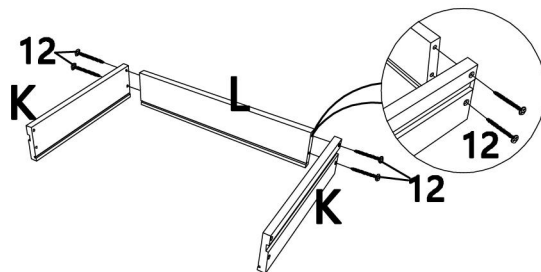

STEP 8

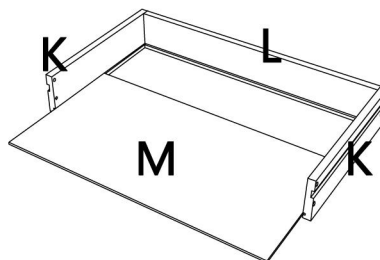

STEP 9  **12X4**  **6X2**
 **7X2**

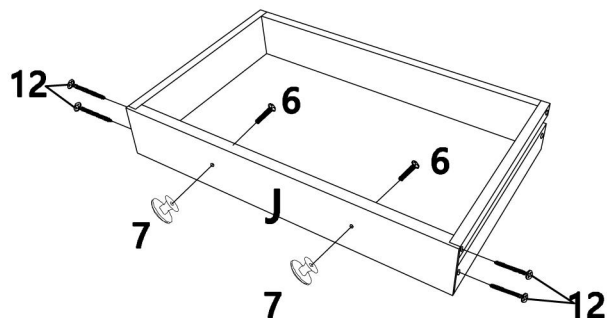

STEP 10  **4X8**

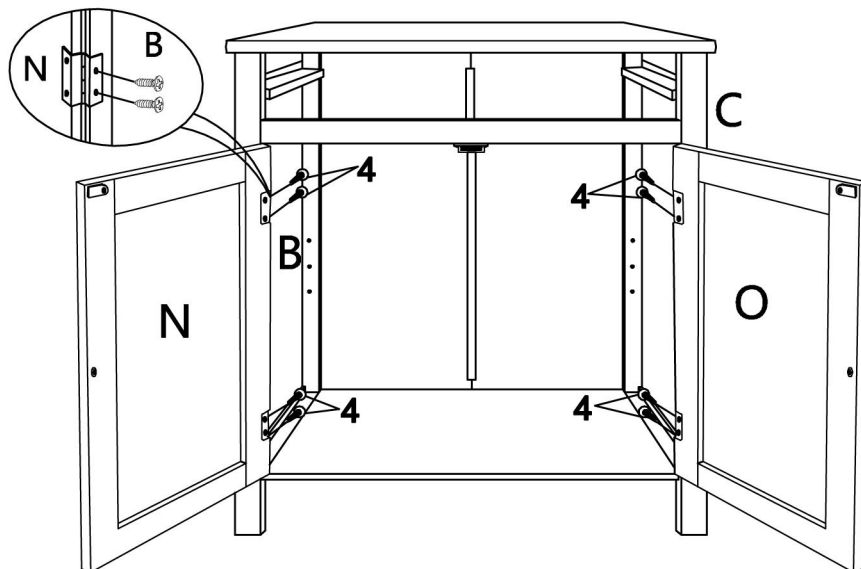

STEP 10  **10X4**

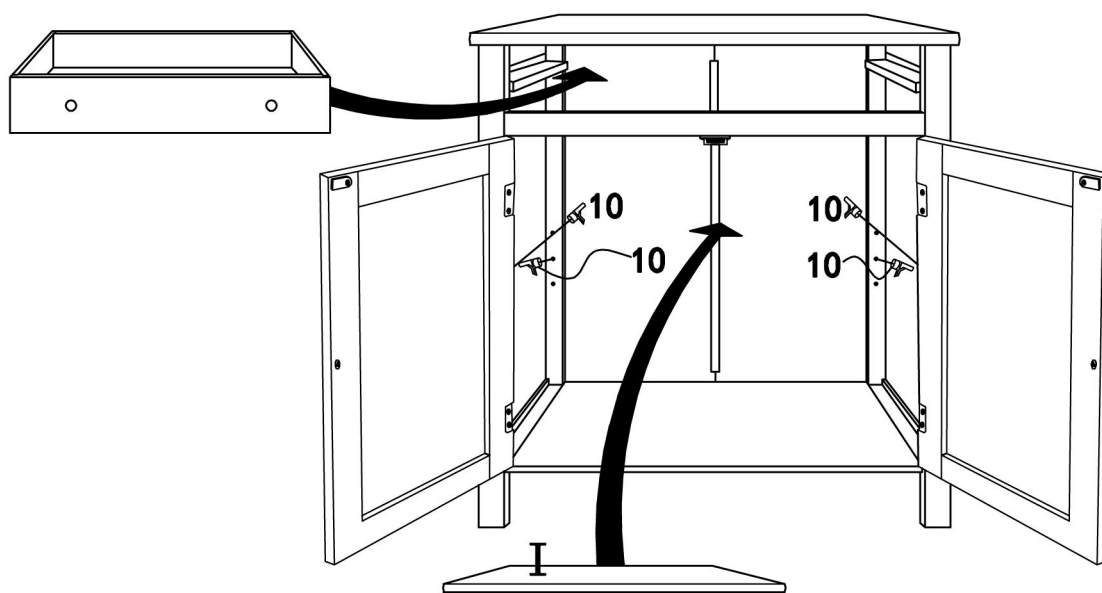

STEP 11

