

ASSEMBLY INSTRUCTIONS

—— Massage Recliner Chair ——

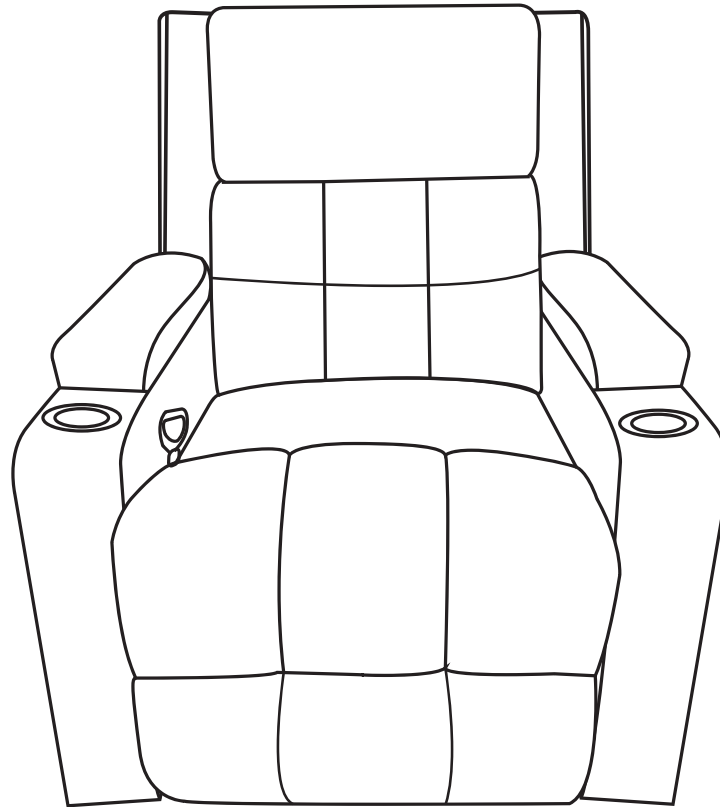

Item will come in 2 boxes and may not arrive at the same day.
If you have any questions regarding the use of this unit, or find
that your recliner needs service, please contact us directly.

Massage Recliner Chair Assembly Instruction

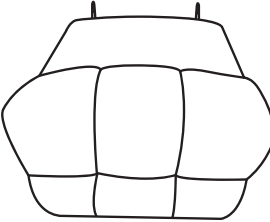
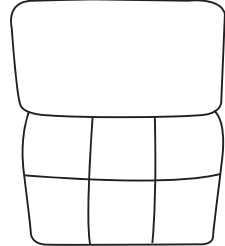
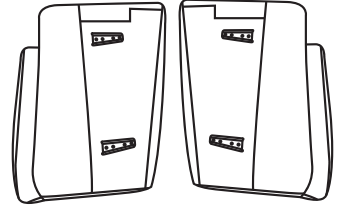
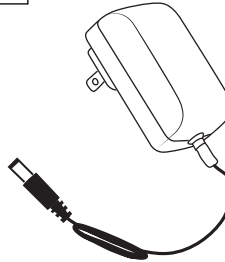
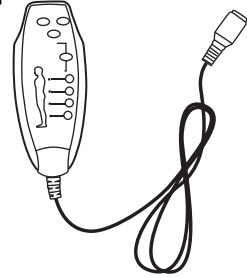
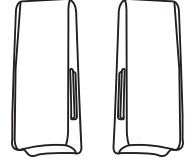
A 	B 	C 	D 	E 	F 
Chair base	Backrest	Left and right armrest	Power cord	Remote control	Left and right ears

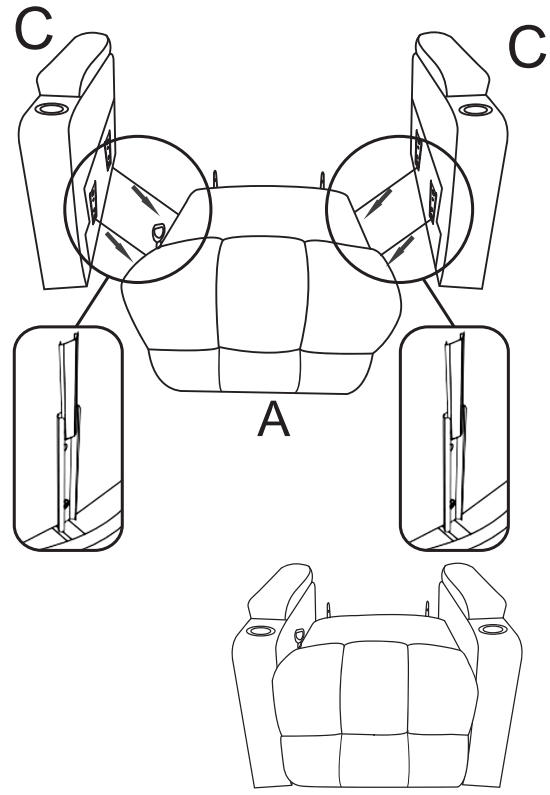
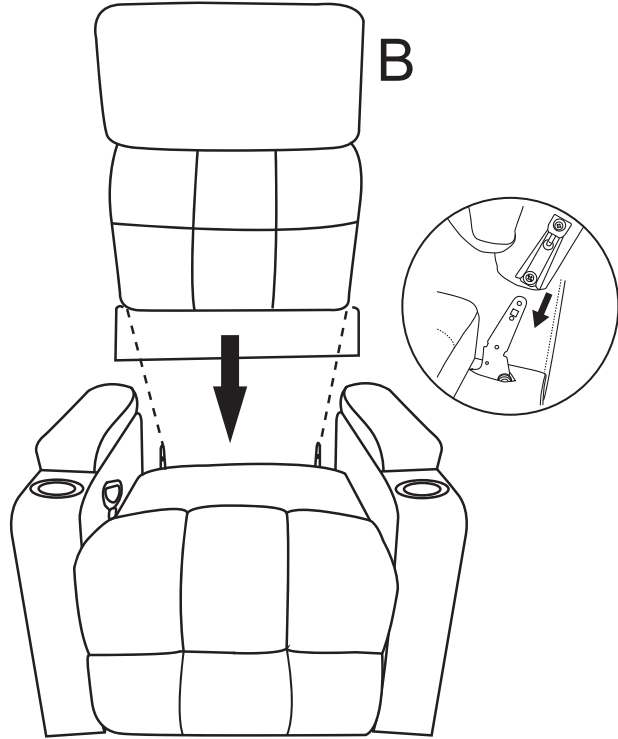
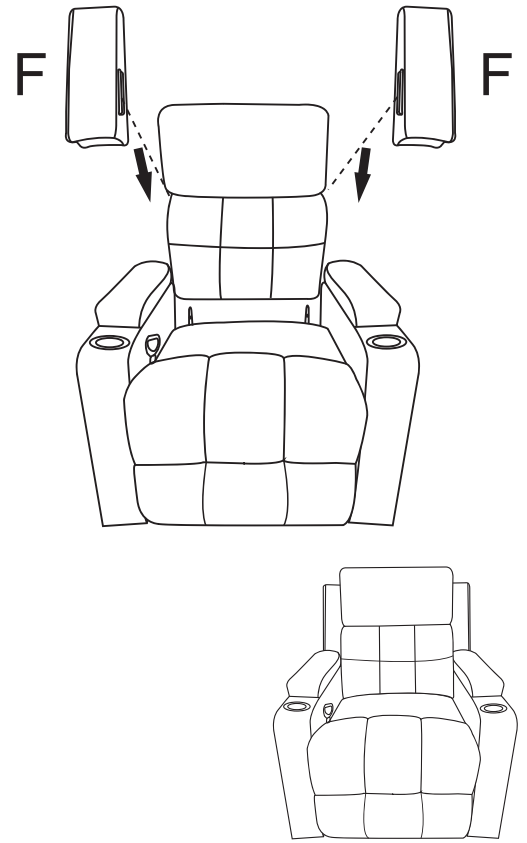
STEP 1 	STEP 2 	STEP 3 
---	--	---

Massage Recliner Chair Assembly Instruction

STEP 3

No.1 and No.2 wire connect with the backrest and chair base.
No.3 wire connects with backrest and power cord(D).
No.4 wire connects with backrest and remote control(E).

NOTE: Two same color wires connect.

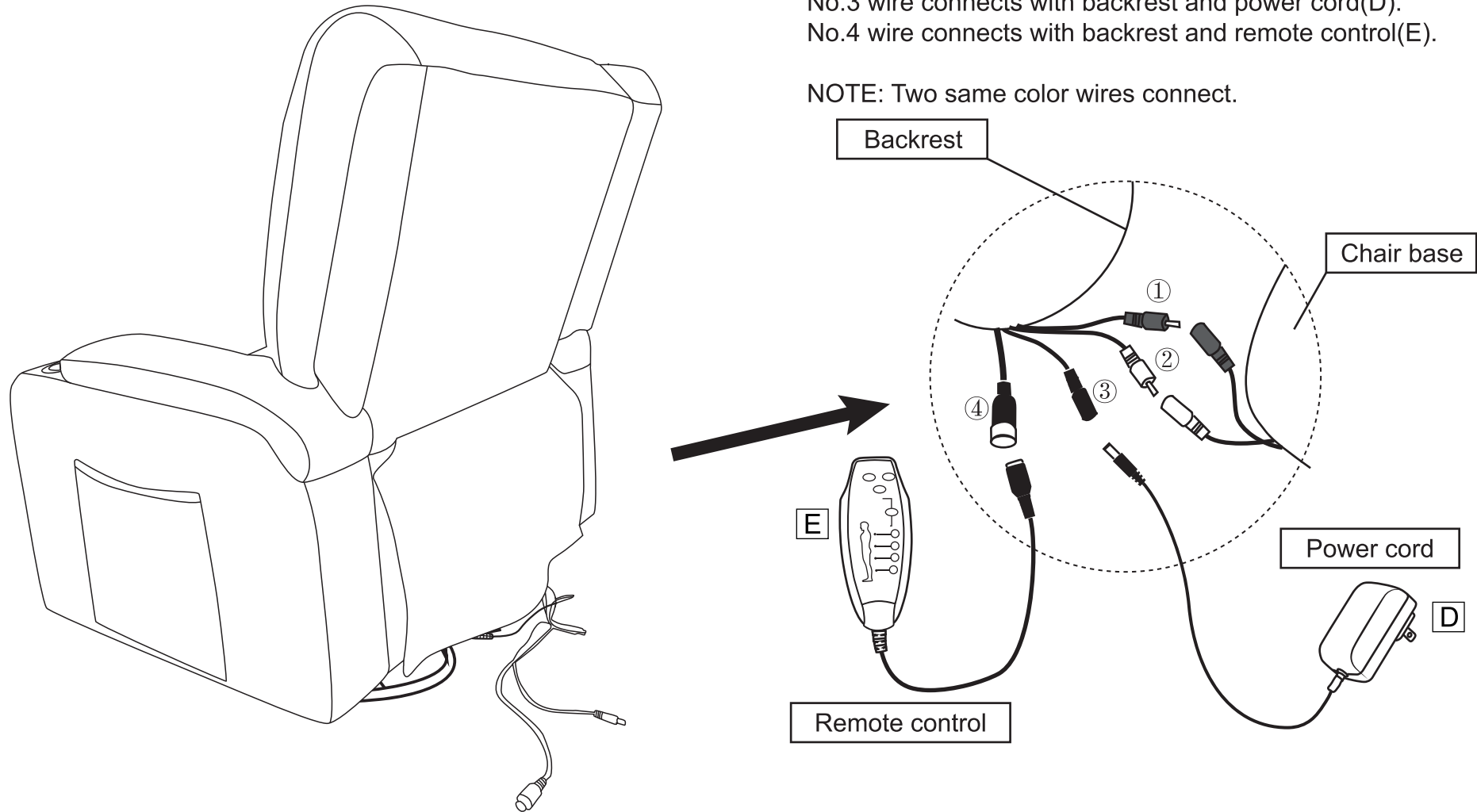

Massage Recliner Chair Assembly Instruction

How to recline?

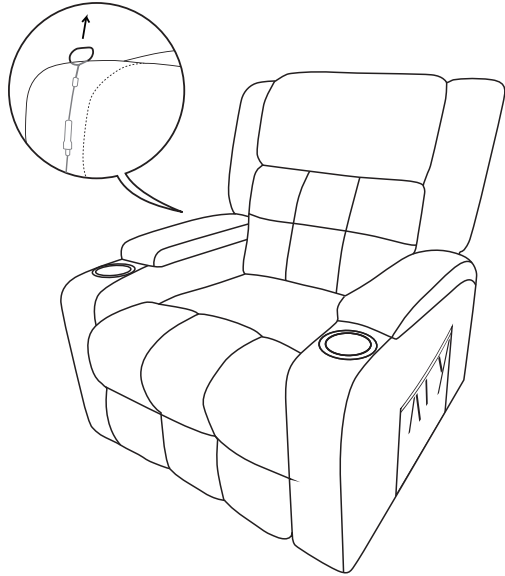

1. Lift the handle up to release footrest

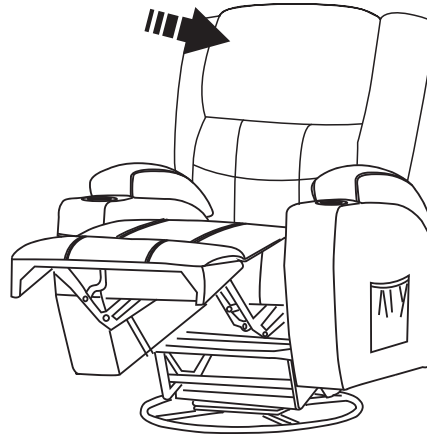

2. Sit deeper on the chair, put hands on armrests, lie down and use both head and back strength to recline

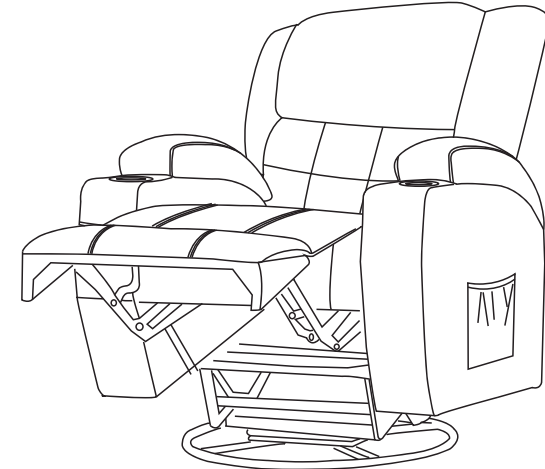

3. Have a relax on chair

How to get footrest latch down?

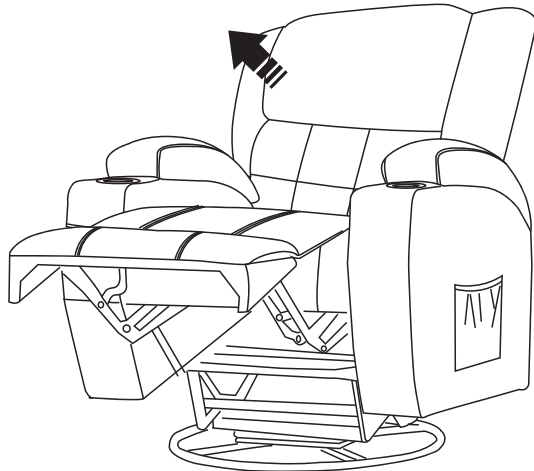

1. Sit on the chair (not recline), backrest will be back.

NOTE : footrest will not close in reclined position.

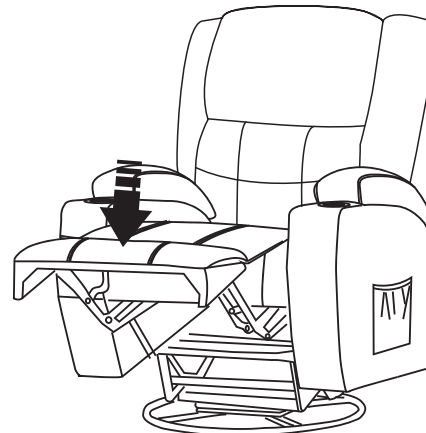

2. Press the bottom of footrest with some strength (with feet).

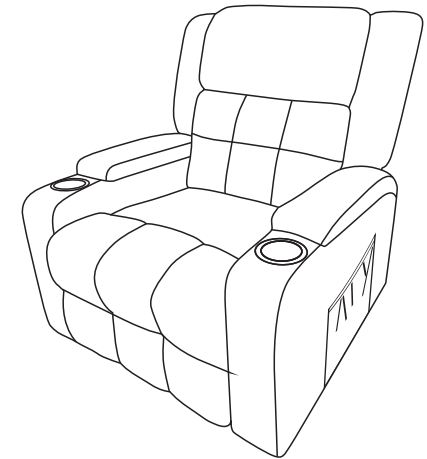

3. The chair will be in seated position

Massage Recliner Assembly Instruction

How to use remote control?

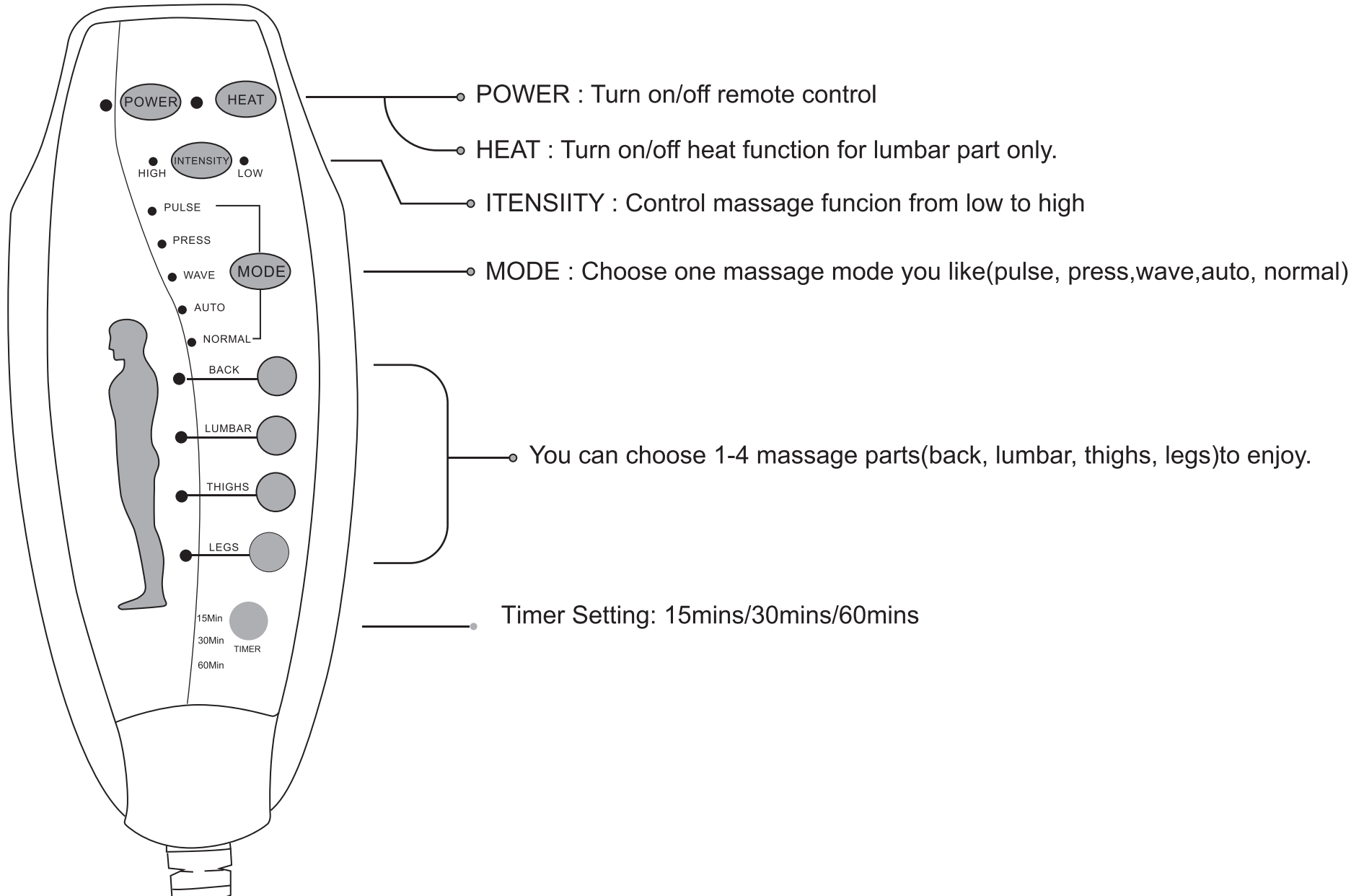

Massage Recliner Assembly Instruction

FAQ:

Q1: How to release the footrest and recline?

A1: There is a black handle in the right side of the chair. Please lift it up(you may need a little strength), then the footrest will be raised. Then you could sit deeper to recline on the chair and get reclined.

Tips: When the footrest get raised, please sit deeper on the chair, also put two hands on the chair's armrests, then lie down on the chair with back and hands strength. This will help you get reclined much easier.

Notes: The chair cannot always keep in the reclined position when your back leave the chair.

Q2: How to make the footrest go back down?

A2: Let the chair back returned to the seated position, and use your feet to push the bottom of the footrest to close the footrest. When you hear a click sound, footrest get closed.

Note: The new chair may need more strength to lock down. It will be much easier to close after several times using.

Q3: Cannot massage or heat?

A3: There are 3 reasons leading to the issue that cannot massage or heat.

(1) Power Cord Problem: Please check the indicator light up or not on the power source.

(2) Remote Control Problem: Please check the heat/power button on the remote control light up or not.

(3) Wire Connected Problem: There are 4 wires needed to be connected. Please make sure the wires connected correctly. The wire of the same color should be connected together.

We check each chair before shipping out to make sure the item is in good condition, so any problems, please contact us freely.

Q4: How to connect the power and remote control with the chair?

There are 4 wires from the chair needed to be connected.

No.1 and No.2 wire connect the backrest and cushion.

No.3 wire connects the backrest and remote control(E).

No.4 wire connects the backrest and power cord(D).

Note:

Please try to solve the problem by the way above. Feel free to contact us via email for further help if it's still unavailable.

We will try our best to help you solve your any concerns.