

ASSEMBLY INSTRUCTION

Slim Rack

Slim Rack 16.7"Lx9"Wx34"H

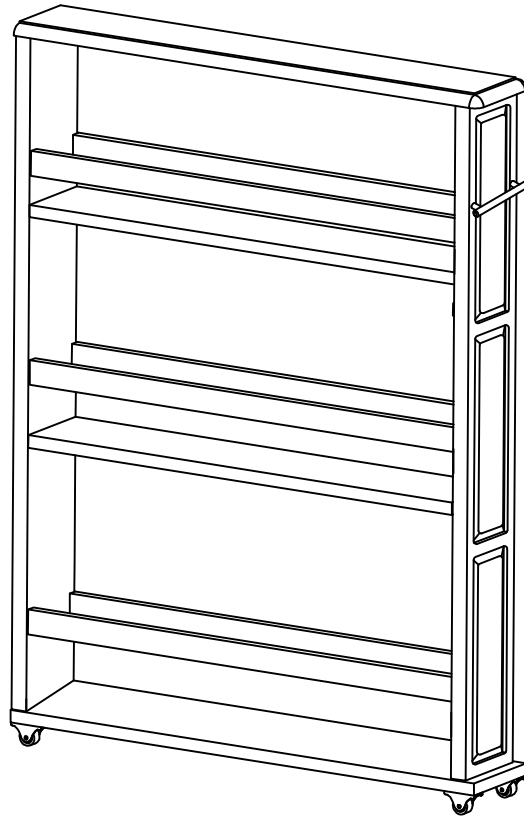

Customer Service

If you have any questions about assembly or possible missing parts, please contact us and we will be glad to assist you.

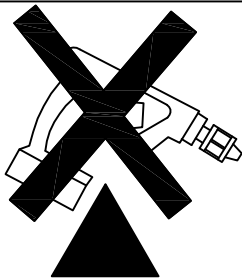

- . Use of power tool to assemble this product will invalidate any claim and damage this product making it unsafe !!!
- . Please assemble on a clean soft surface to avoid damage.

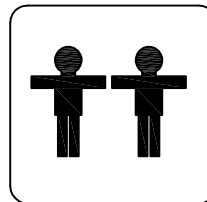

Tools Required

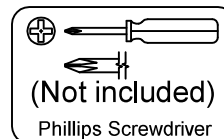

Part list - Slim Rack

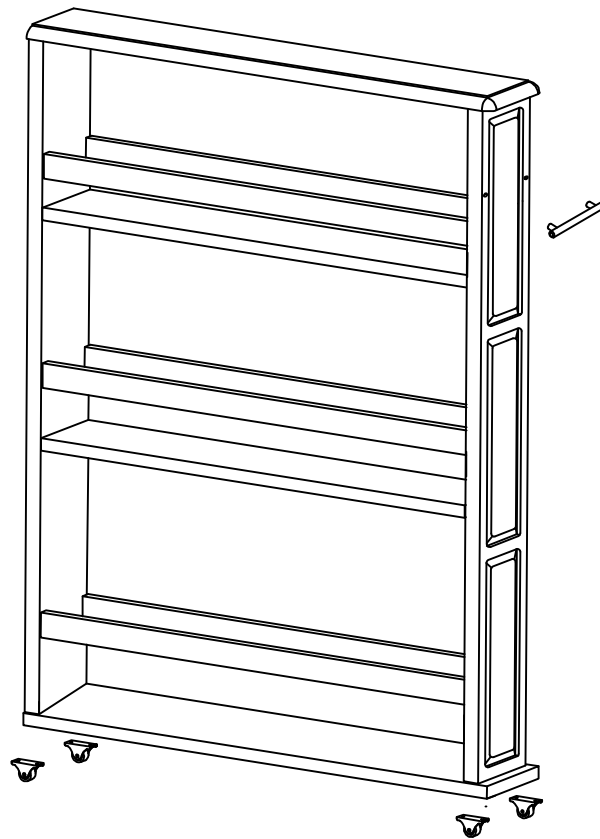

Identifying the hardware-Identify the hardware using the illustrations below

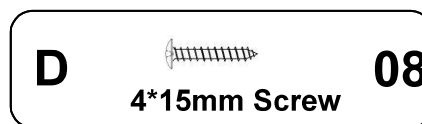
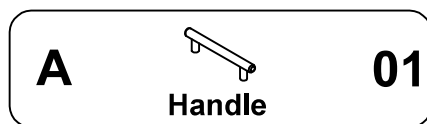

Step 01

D  **08**

B  **04**

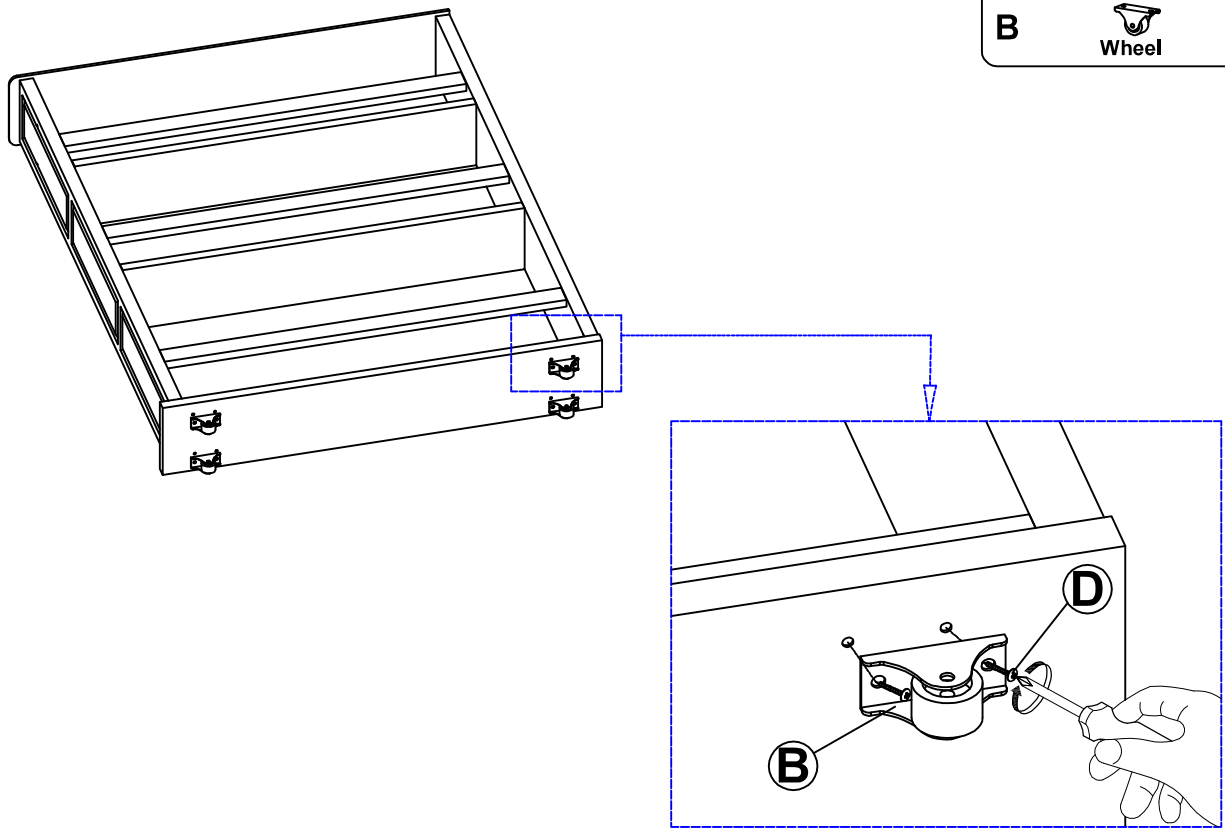

Step 02

A  **01**

C  **02**

