



Evora Counter Stool  
Assembly Instructions



## Parts List

Label	Picture	Description	QTY
A		Seat	1
B		Chair Leg	1

## Hardware

Label	Picture	Description	QTY
F		Bolt	4
G		Flat Washer	4
H		Allen Key	1

## Assembly Preparation

### Before Beginning Assembly:



- Read instructions, cover to cover-



- Have 2 adults on hand for assembly-



- Do not assemble on flooring or carpet-



- Assemble on a clean non-marring surface (packing foam)-



- Save all packaging until finished-

*Need a part? Call TOV at 516-888-3355 or email [service@tovfurniture.com](mailto:service@tovfurniture.com)*

# Assembly Steps

## Step 1

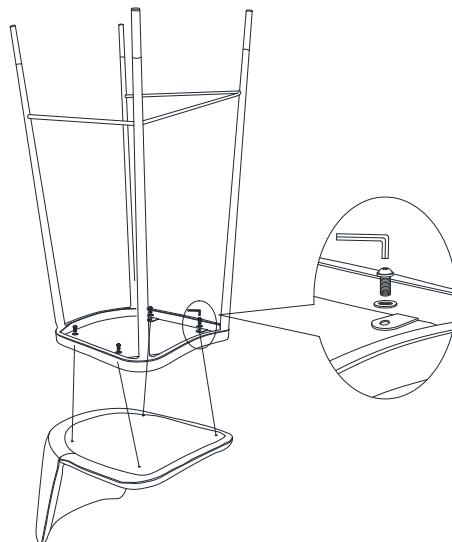









Place the seat faced down as shown

Align the holes of the leg frame and seat and attach with provided hardware.

## Step 2



## Care & Maintenance

-  Do not put hot items directly on furniture surface.
-  Do not clean furniture with harsh cleansers or polish.
-  Do not place furniture under direct sunlight.
-  Do not place furniture near heating or cooling vents.
-  Do not write on furniture without a padded barrier to protect the surface.
-  Do not place furniture outside. For indoor use only.
-  Not for commercial use. For residential use only.
-  Stains may be removed with mild soap solution and damp cloth.

- 
-  Dust and pick-up spills using a clean, non-colored, lint-free cloth.