

# CONTENTS

---

Safety and care advice	<b>1</b>
Components – panels	<b>2</b>
Components – fittings	<b>3</b>
Assembly instructions	<b>4</b>

---

# ⚠️ SAFETY AND CARE ADVICE ⚠️

---

## PLEASE READ THESE INSTRUCTIONS CAREFULLY AND KEEP FOR FUTURE REFERENCE

- **Warning:** This unit weighs approximately 75kgs. Please lift with care.
- Check you have all the components and tools listed on pages 2 and 3.
- Remove all fittings from the plastic bags and separate them into their groups.
- Keep children and animals away from the work area, small parts could choke if swallowed.
- Make sure you have enough space to layout the parts before starting.
- Do not stand or put weight on the product, this could cause damage.
- Assemble the item as close to its final position (in the same room) as possible.

- Assemble on a soft level surface to avoid damaging the unit or your floor (use opened out unit carton).



- We do not recommend the use of power drill/drivers **for inserting screws**, as this could damage the unit. Only use hand screwdrivers.
- **Safety note:** If there is any chance of this unit being pulled over by children etc. it is recommended that the unit is secured to a wall using suitable fixings.
- Dispose of all packaging carefully and responsibly.

## CARE AND MAINTENANCE

---

- Only clean using a damp cloth and mild detergent, do not use bleach or abrasive cleaners.
- From time to time check that there are no loose screws on this unit.

- This product should not be discarded with household waste. Take to your local authority waste disposal center.

**Note** If required the next page can be cut out and used as reference throughout the assembly. Keep this page with these instructions for future reference.

# COMPONENTS

Ensure the following components are in the box before proceeding with assembly:



**A** x1

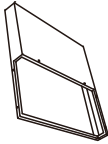

**B** x1



**C** x1

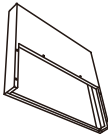

**D** x1



**E** x1



**F** x1

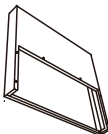

**G** x1



**H** x1



**I** x1

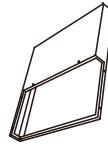

**J** x1



**K** x1

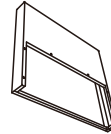

**L** x1



**M** x1



# COMPONENTS

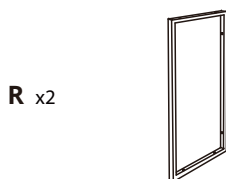
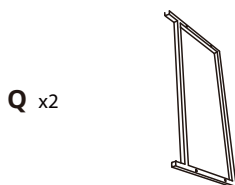
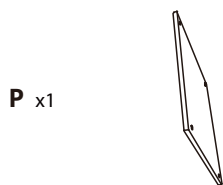
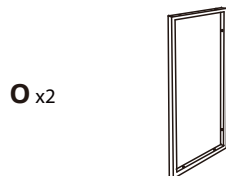
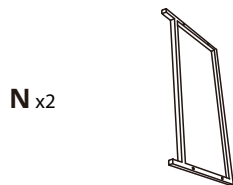



# ASSEMBLY INSTRUCTIONS

Please note, When building this product bolts should be finger tightened until all parts are in place. Only once all parts and bolts are assembled should bolts them be fully tightened using the ratchet.

## Step 1

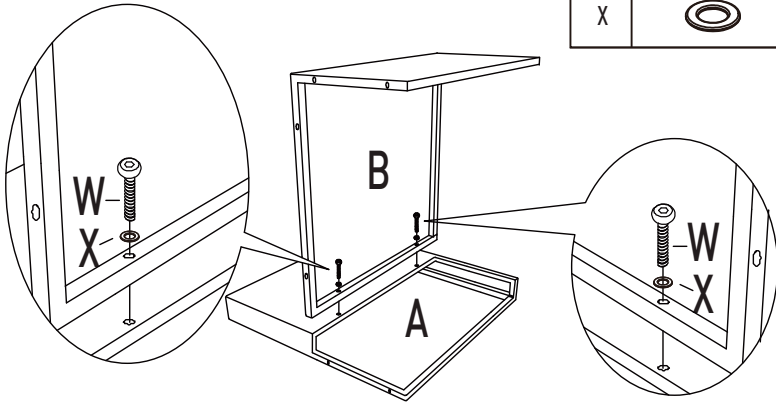

Left Side Sofa

V		1
W		2
X		2



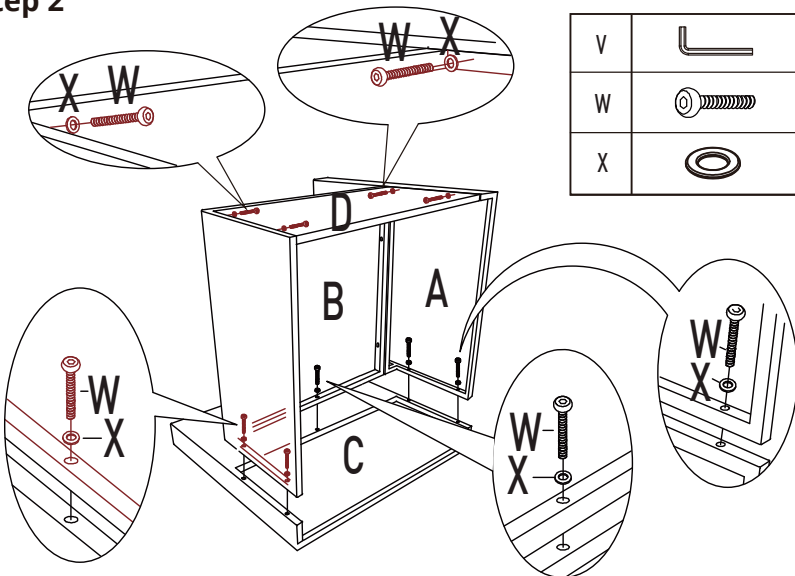

## Step 2



V		1
W		9
X		9

# ASSEMBLY INSTRUCTIONS

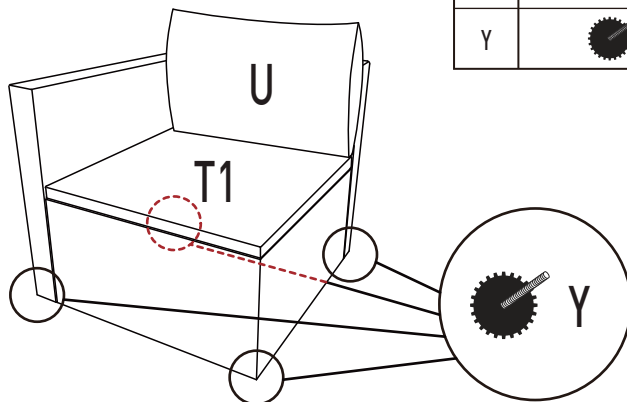

## Step 3

T1		1
U		1
Y		4



## Step 4

Rattan Center Sofa

V		1
W		4
X		4

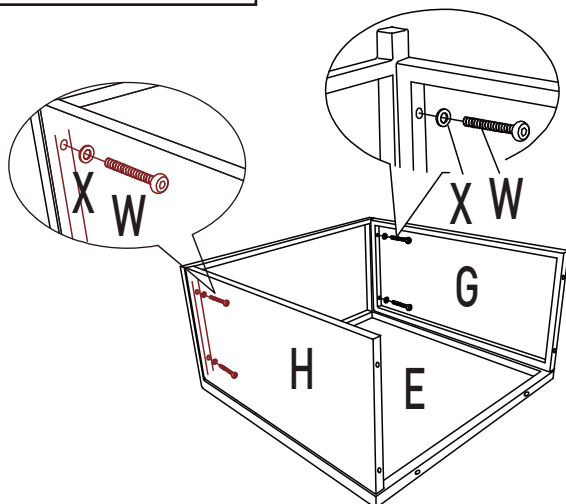

# ASSEMBLY INSTRUCTIONS

## Step 5

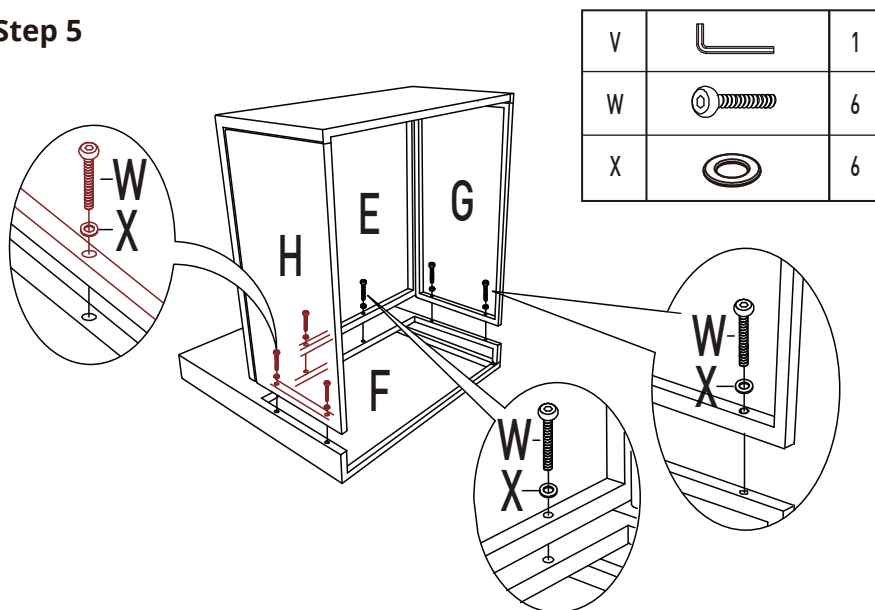

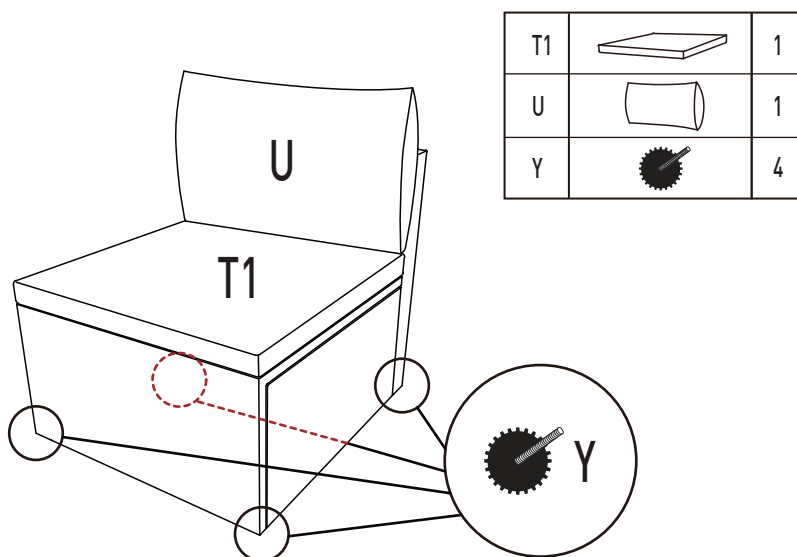

## Step 6



# ASSEMBLY INSTRUCTIONS



## Step 7

Right Side Sofa

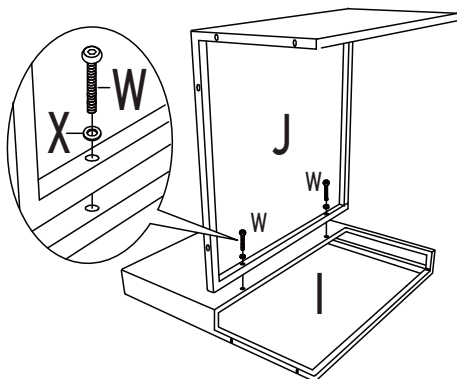
V		1
W		2
X		2



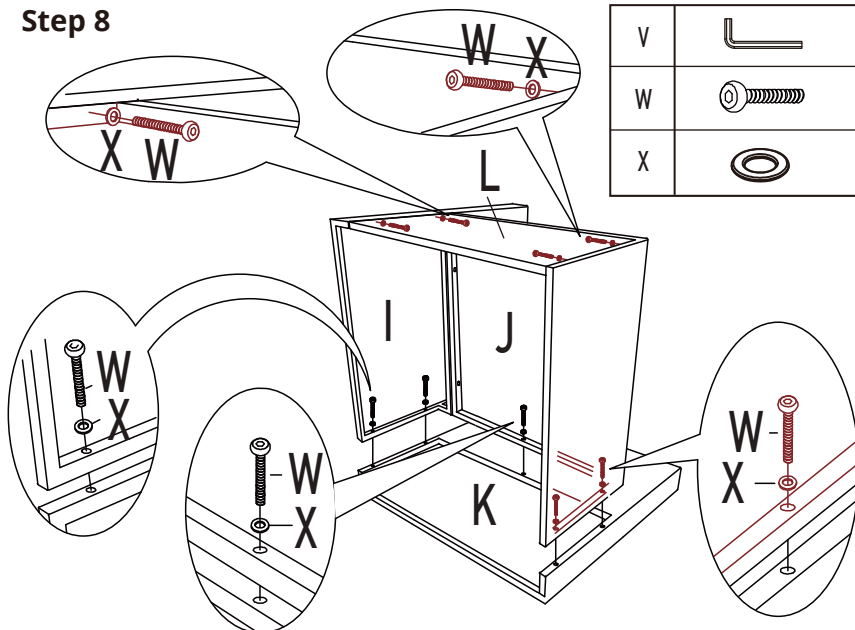

## Step 8

V		1
W		9
X		9



# ASSEMBLY INSTRUCTIONS

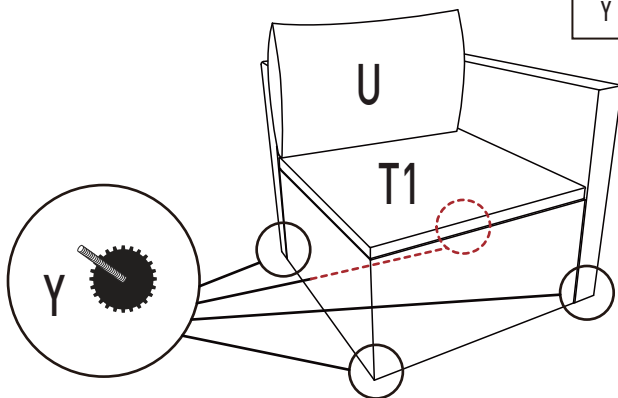

## Step 9

T1		1
U		1
Y		4



## Step 10

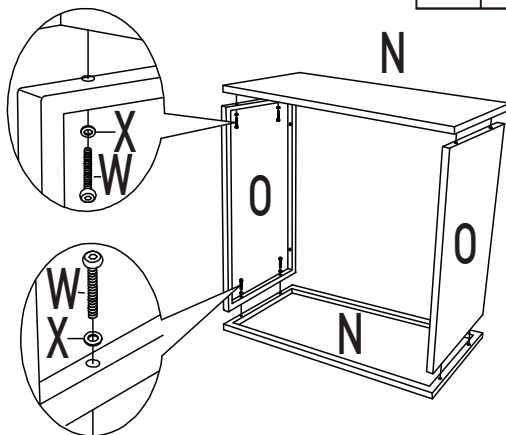

Rattan Stool

V		1
W		8
X		8





# ASSEMBLY INSTRUCTIONS

## Step 11

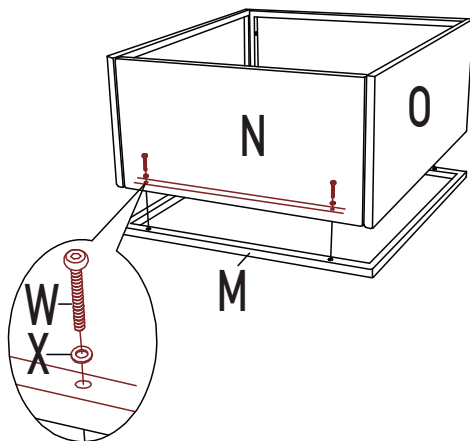
V		1
W		4
X		4



## Step 12

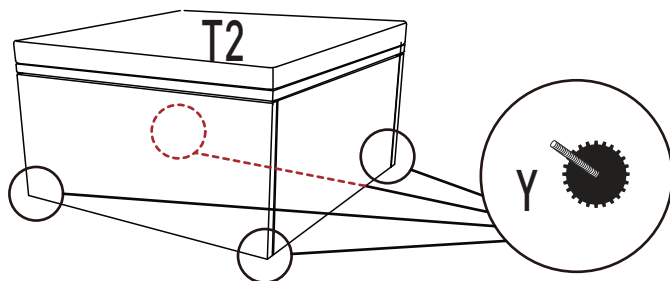

T2		1
Y		4



# ASSEMBLY INSTRUCTIONS

## Step 13

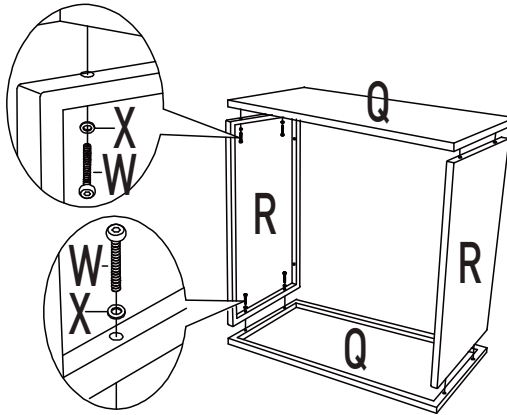

Rattan Center Table

V		1
W		8
X		8



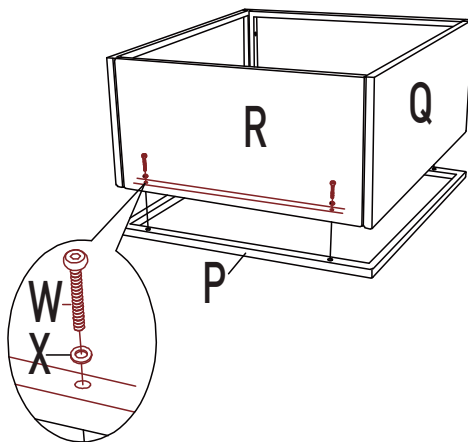

## Step 14



V		1
W		4
X		4

# ASSEMBLY INSTRUCTIONS

## Step 15

S		1
Y		4

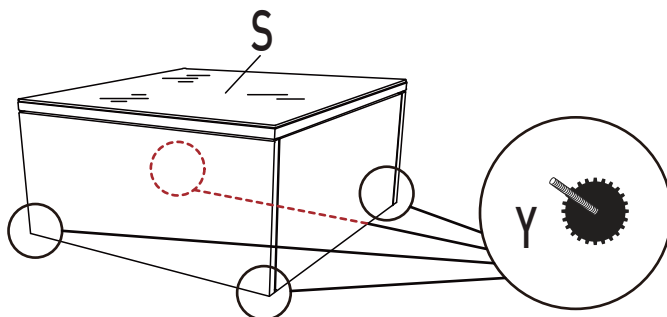

## Step 16

Z		3
---	---	---

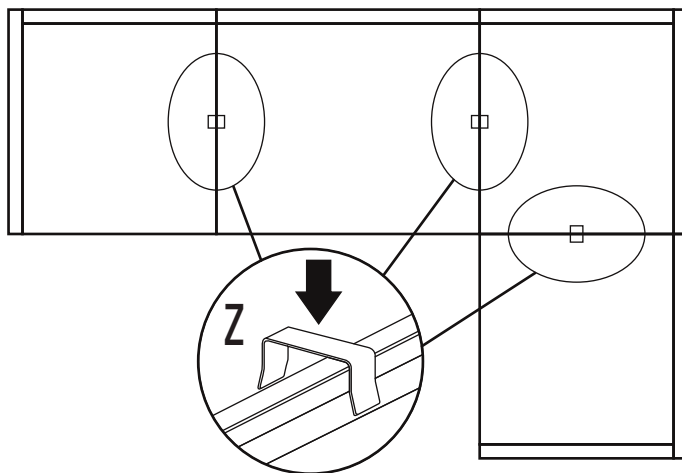

# ASSEMBLY INSTRUCTIONS

---

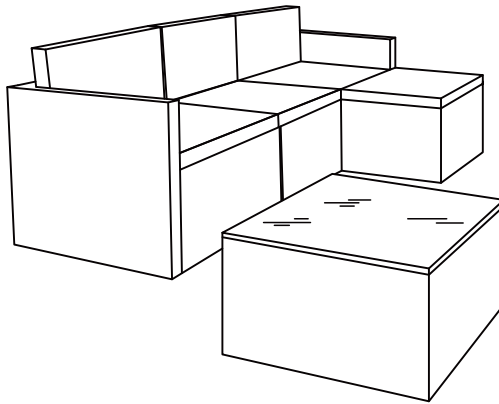

Congratulations! Now you have finished assembling the product. There may be some dust or hand marks on your item, we recommend using a standard wood polish to clean this product.