

# COMPUTER DESK

## MONTAJ KILAVUZU / ASSEMBLY MANUAL

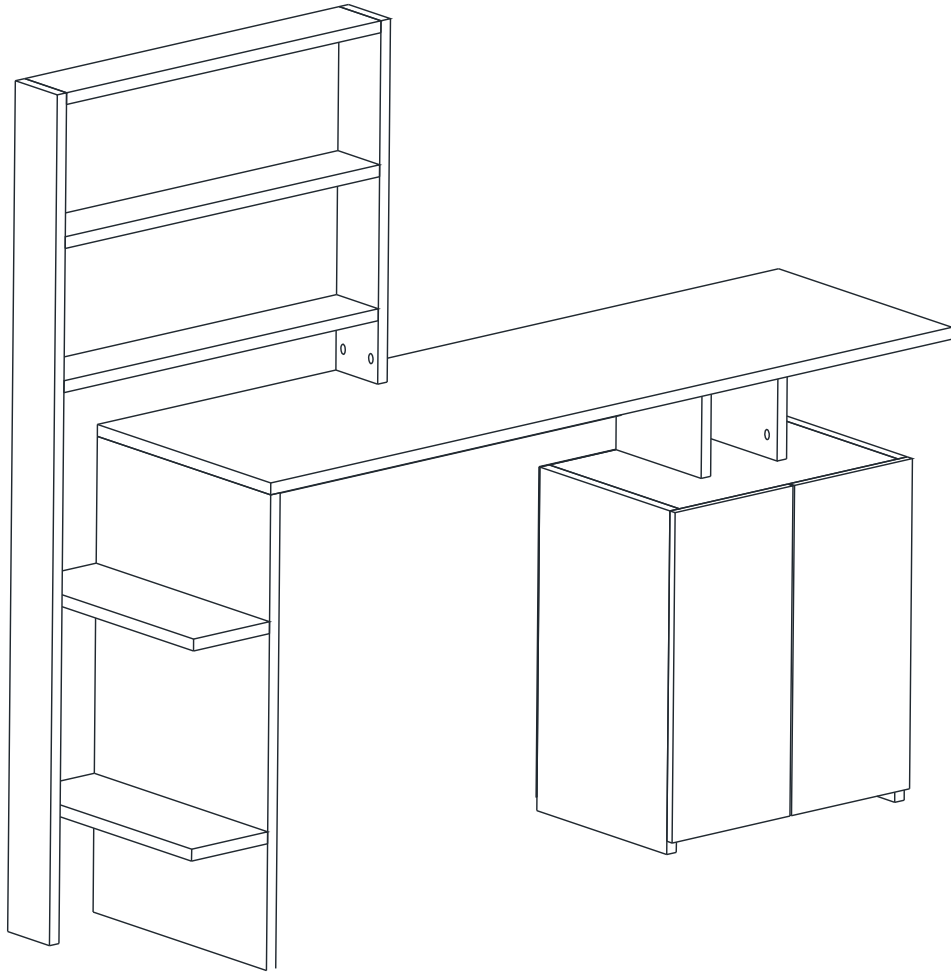

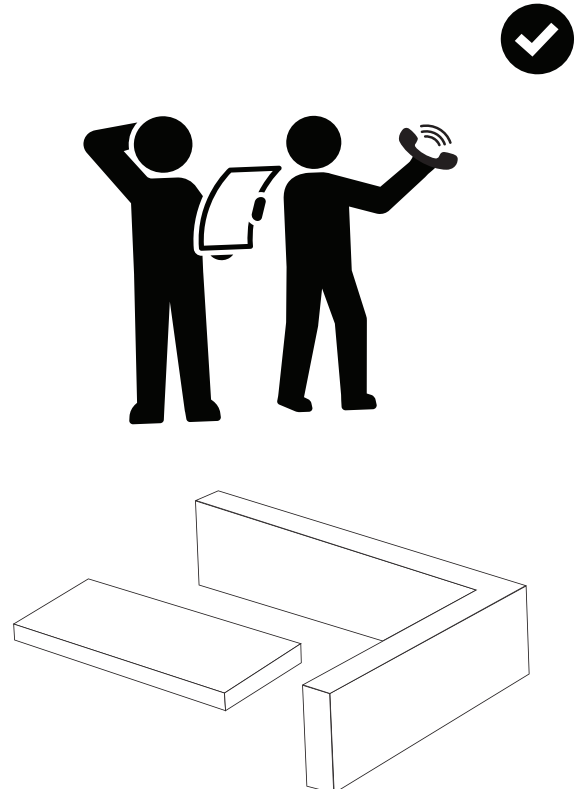

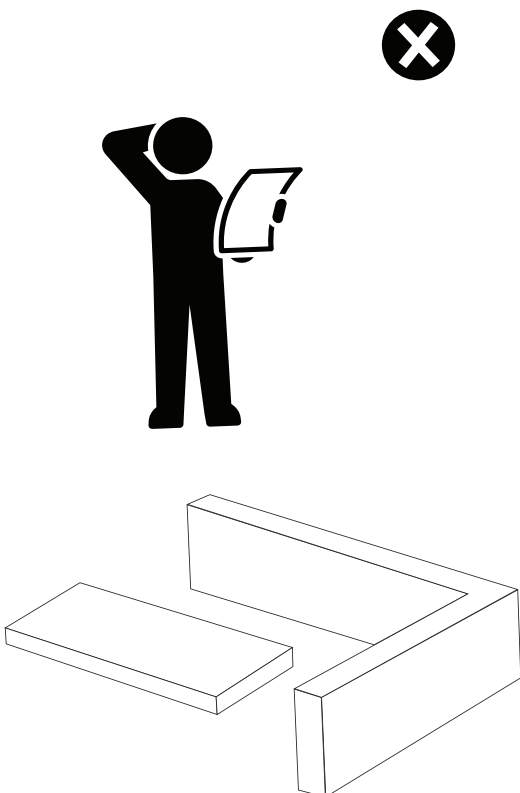
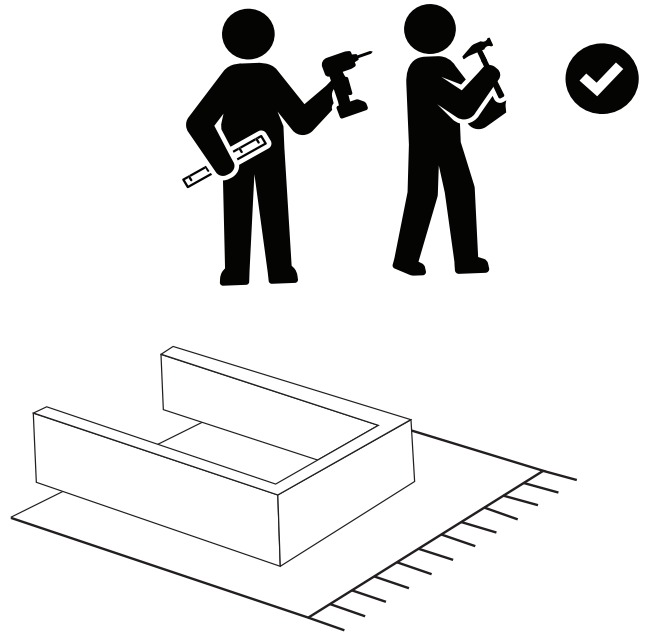
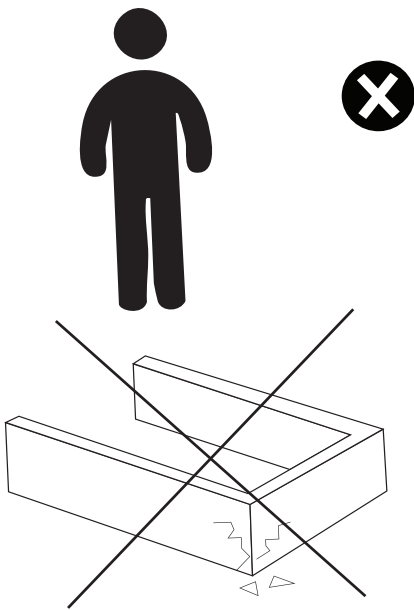
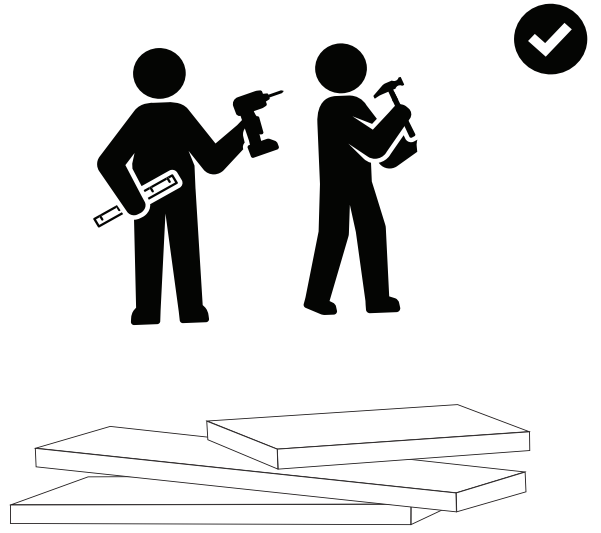
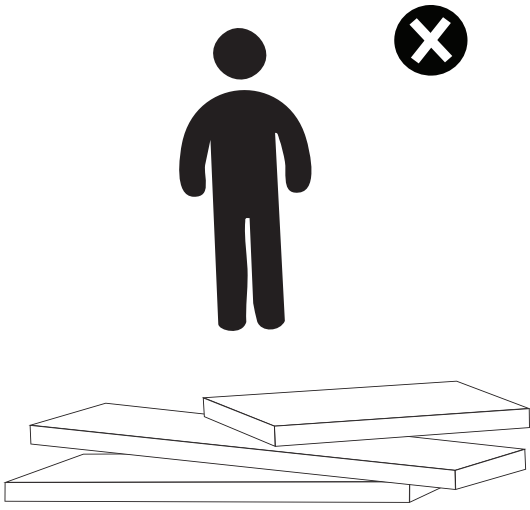
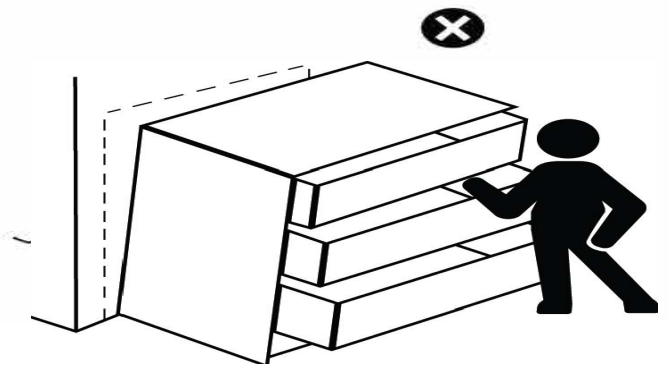
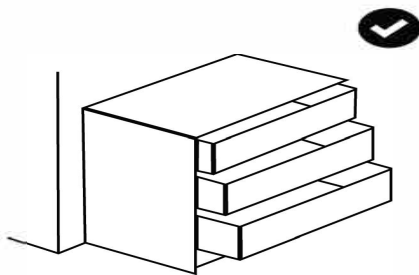
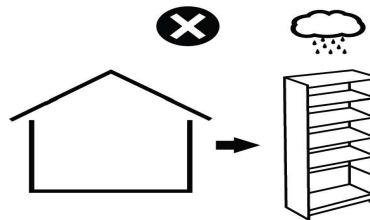
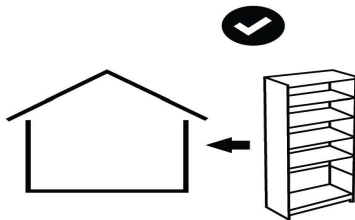
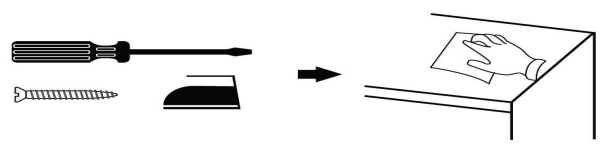
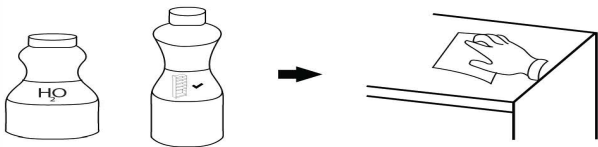
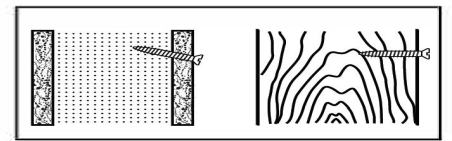
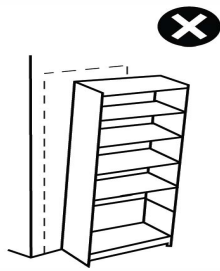
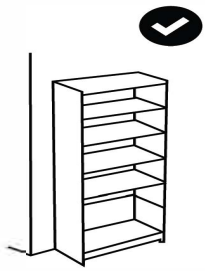
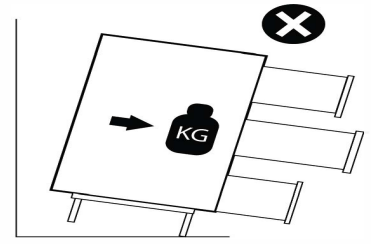
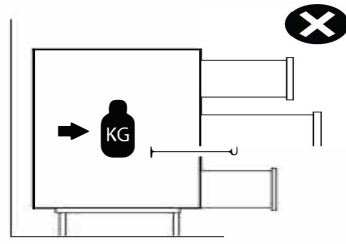
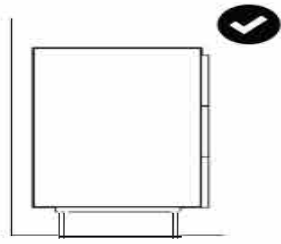



**Dear Customer,**

We are delighted to meet your needs and hope you enjoy our products. May they bring joy to you and your family. Please be assured that this product has successfully passed all safety and health tests. Thank you for choosing us!



### **Assembly Recommendations**

We kindly recommend checking the components and accessories listed in the installation guide before beginning assembly. If you have purchased multiple products (we're happy to hear that!), we suggest completing the assembly of the first product before moving on to the second.



We recommend that you clean all parts with a slightly damp cloth before assembling the product.

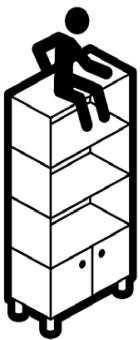

### **Safety Instructions**

Please avoid using the products for purposes other than their intended use. It is crucial for the safety and well-being of you and your family to prevent any risk of injury. To ensure the longevity of the product, please keep it away from excessive heat, cold, and humidity.



### **WARNING!**

Securing the furniture to the wall is highly recommended for your safety. Furniture tipovers can result in serious injuries or even fatal accidents. To prevent such risks, please ensure your furniture is securely fixed to the wall. Please note that fixing devices are not included in the package, as different wall types require different solutions. Use suitable fixing devices that you trust. If you are unsure which devices to use, we recommend consulting your local dealer for guidance. Do not undo or remove the drawer locking system.

Bu modülün kurulumu için gerekli olan araçlar.

The necessary tools (not included)

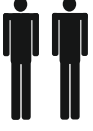



Bu modül iki (2) kişi tarafından kurulmalıdır.  
This unit should be assembled by two (2) persons

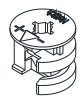
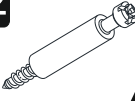
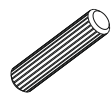
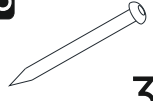
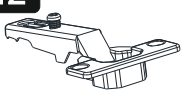
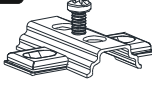

Bu modülün kurulumu için gerekli olan araçlar.  
The necessary tools (not included)

## AKSESUAR LİSTESİ / ACCESSORY LIST

<b>A10</b> 3,5x18  16x	<b>A01</b> Minifix Gövde  48x	<b>A02</b> Minifix Mil  48x	<b>A03</b> Kavela  48x	<b>A28</b> Arkalık Çivisi  30x
<b>A12</b> Düz Menteşe  4x	<b>A13</b> Menteşe Altlığı  4x	<b>A16</b> Büyük Tapa  25x Ana Renk	<b>A16</b> Büyük Tapa  23x Değişken	

## PARÇA KODLAMA / GENERAL VIEW

