

PRODUCT ASSEMBLY INSTRUCTIONS

[Product Model: FS164-480]

List :

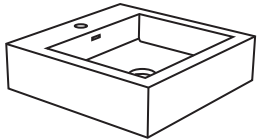

Solid Surface Bathroom Sink x1

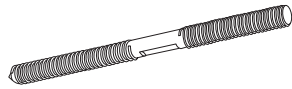

Fastener x4



Gaskets x4



Nut x4



Expansion sleeve x4

Tools Required :

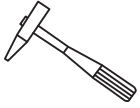

Hammer

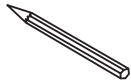

Pencil

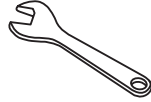

Wrench



Electrodrill

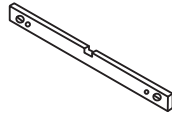

Gradienter

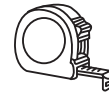

Steel tape

Installation steps : 1

Measure the distance of the mounting holes, and the height you want, mark with the pencil.
(33"-36" is preferred for countertop height).

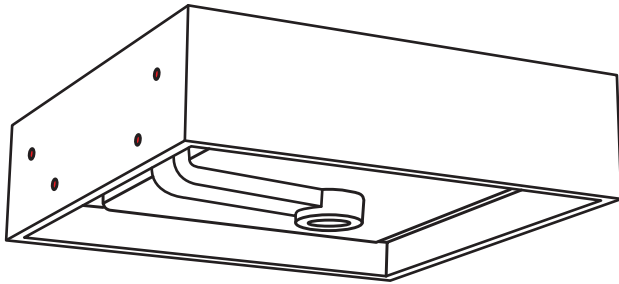

[The back of the product]

Installation steps : 2

Drill the hole at the mark with electric drill.

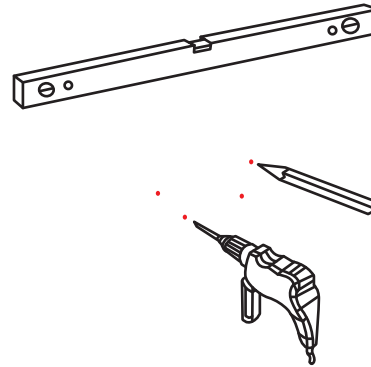

Installation steps : 3

Install the expansion sleeve first, then the screws.
⚠ Make sure the screws are securely installed.

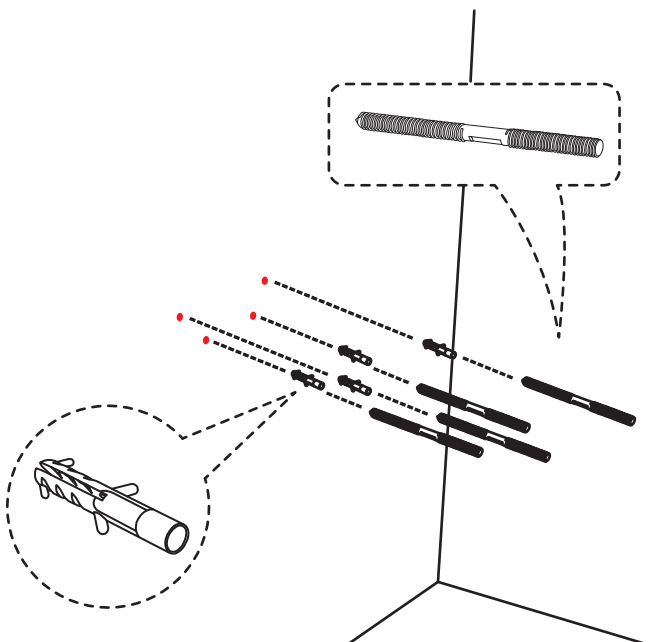

Installation steps : 4

Hold the basin and use a spanner to lock the basin to the wall.

