

Name: Drip A/03

Design: Christophe Mathieu / 2017

Typology: Wall Lamp

Environment: Indoor







Technical description:

Drip is an extensive family of luminaires designed for all types of applications, from residential & hospitality applications to retail and corporate.

The arm is in a fixed position. The fixture includes a USB port and a switch located in the structure below the tray. The glass can be cleaned with easy removal from the structure. It does not have screws. Water and non-abrasive soap can be used for cleaning and maintenance.



Lamps description

| |
|---|
|  Grounding: compulsory |
|  3 W LED Lumens: 345 lm CRI: 90 Degrees Kelvin: 2700° |
| Voltage: 120V~60Hz |
|  1 Box 12.60 x 12.60 x 25.98 inches |
| Vol.: 2.3873 ft ³ |
| Weight: 6.61 lbs / Net weight: 4.41 lbs |
| Fire Resistance: TB 117 : 2013 BS 5852 CRIB 5 BS 5852-1 PART I IMO RESOLUTION A.652 (16) EN 1021-1 EN 1021-2 UNI 9175 CLASSE 11M |
| Glow Wire Test: until 700°C Value: GWFI 700/1,23 |
| Certifications:   |
|  Photometrics made according to the position the lights are shown in the catalogue and price list. |

Ref Finishings

| | |
|---|-------------------|
| 2590300738U | Transparent Glass |
| 2590300739U | Frosted Glass |
| 2590300781U | Green Glass |
| 2590300786U | Blue Glass |
| Structure finish: Ebony black | |
| Borosilicate glass | |
| The inside of the tray includes a taupe coated fabric | |
| Weight capacity of the tray: 4.41 lbs | |
| USB port | |
| With switch | |
| IMPORTANT NOTE: Wall sconce product photography doesn't show US backplate mounting. | |
| Customizable | |

Measures

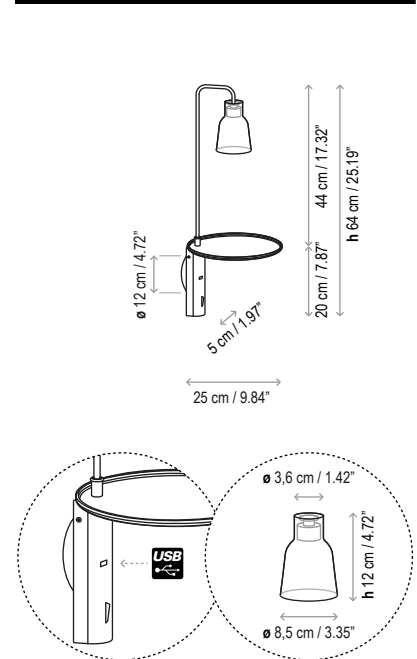

Drip A/01

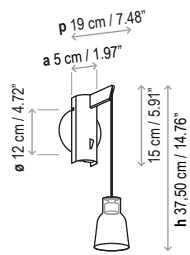

Drip A/02

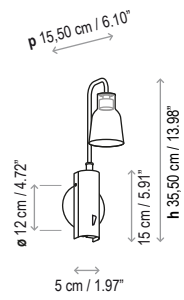

Drip A/03

