

ASSEMBLY INSTRUCTION

DOUBLE RECLINING LOVE SEAT WITH CENTER CONSOLE

CONSOLE BACK REST IS STORED IN THE BOTTOM OF THE SEAT, PLESAE TAKE OUT FOR ASSEMBLY.

NO.	PARTS LIST	QTY	DESCRIPTION
A		1	SEAT
B		1	LSF BACK REST
C		1	RSF BACK REST
D		1	CONSOLE BACK REST
E		1	LSF EAR
F		1	RSF EAR

NO.	HARDWARE LIST	QTY	DESCRIPTION
G		2	BOLT

STEP 1

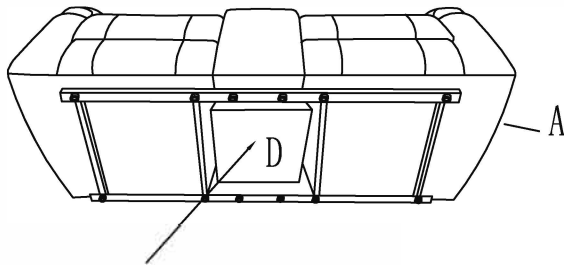

Take out Console back rest for assembly

STEP 2

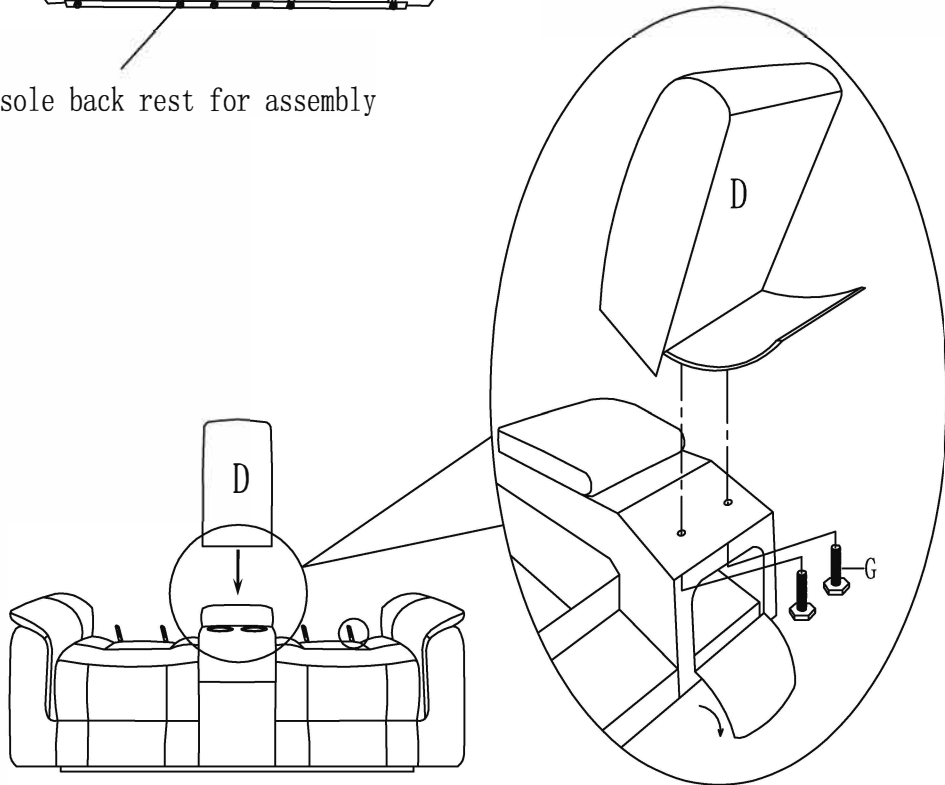

ASSEMBLING INSTRUCTIONS

DOUBLE RECLINING LOVE SEAT WITH CENTER CONSOLE

Step 3 # Align the femal metal bracket at the back onto the male metal bracket at the seat, insert back rest to the seat then push to the end and make sure it is fixed in position securely.

Step 4 # Align the metal bracket at the ear onto the male metal bracket at the back rest, push the ear down and make sune it is fixed in position securely.

STEP 3

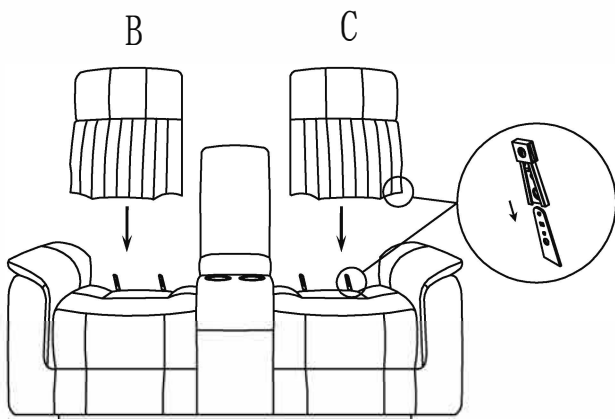

STEP 4

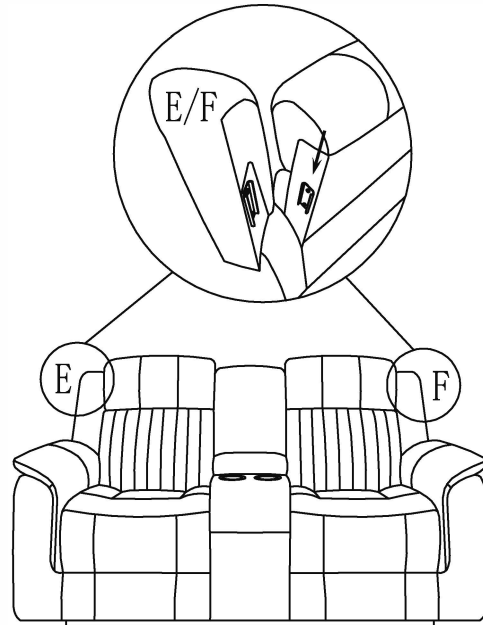

Step 5 # Completed

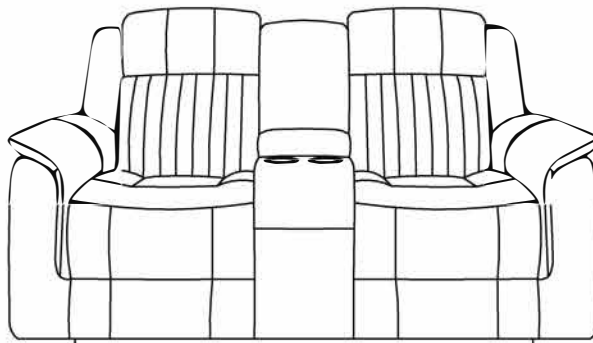



CARE INTRUCTION POLYESTER FURNITURE



In order to maintain the original appearance of your polyester, please follow below simple care procedures.

°Avoid exposing furniture directly to sunlight or heating and air conditioning outlets. Exposure to sunlight or heating and air conditioning outlets will fade/damage polyester.

°Wipe gently with a damp soft cloth to remove dust , dirt and any grime build up.

ASSEMBLY INSTRUCTION DOUBLE RECLINING SOFA

NO.	PARTS LIST	QTY	DESCRIPTION
A		1	SEAT
B		1	LSF BACK REST
C		1	RSF BACK REST

NO.	HARDWARE LIST	QTY	DESCRIPTION
D		1	MIDDLE BACK REST
E		1	LSF EAR
F		1	RSF EAR

Step 1 # Align the femal metal bracket at the back onto the male metal bracket at the seat, insert back rest to the seat then push to the end and make sure it is fixed in position securely.

Step 2 # Align the metal bracket at the ear onto the male metal bracket at the back rest, push the ear down and make sune it is fixed in position securely.

Step 1

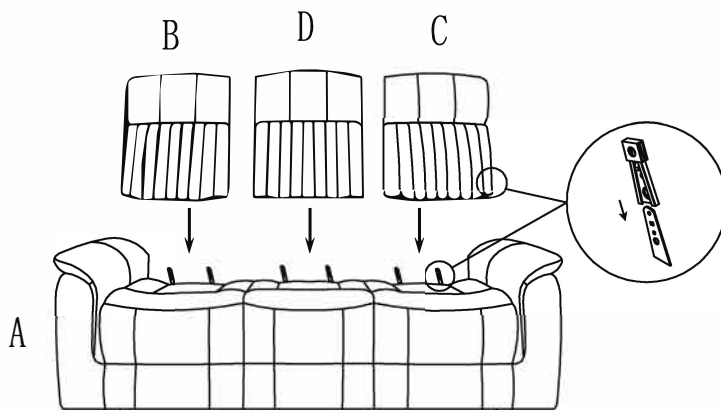

Step 2

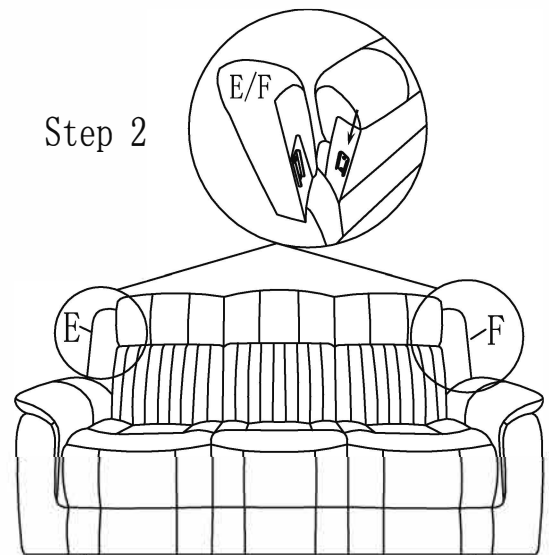

Step 3 # Completed

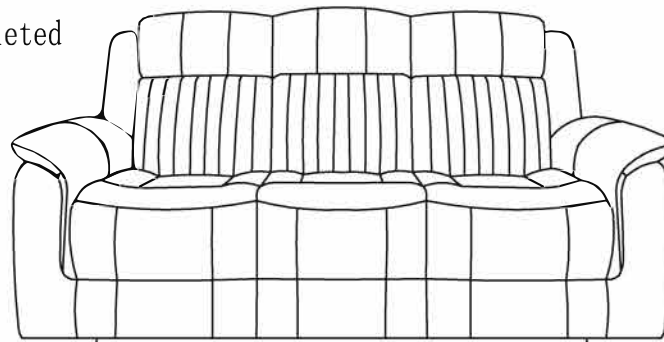

CARE INTRUCTION POLYESTER FURNITURE

In order to maintain the original appearance of your polyester, please follow below simple care procedures.

°Avoid exposing furniture directly to sunlight or heating and air conditioning outlets. Exposure to sunlight or heating and air conditioning outlets will fade/damage polyester.

°Wipe gently with a damp soft cloth to remove dust , dirt and any grime build up.