

ASSEMBLY INSTRUCTION:

1.Initial Tightening

Use a hex key (Allen wrench), not a power drill, to tighten each screw to about 50% before fully securing any of them. Fully tightening one screw too early may cause others to misalign.

2.Final Tightening

Once all parts are aligned, gradually and evenly tighten all screws using the proper tools.









3.Misalignment Fix







If some screws don't line up, loosen all screws to 50%, adjust the parts, and try again.

4.Stability Issue

If the item feels unstable, loosen all screws, adjust it on a flat surface, then retighten them evenly.

Hardware Fittings

Item No.	Reference Image	Description	Qty.	Extra Spare Parts Qty.
A		screw M6*20	8	1
B		washer for M6	16	1
C		spring washer for M6	8	1
D		nut for M6	8	1
E		Screw cap	8	1
F		allen key for M6	1	0
G		Spanner for M6	1	0
H		Adjustable foot pads	4	1

Item No.	Reference Image	Description	Qty.	Extra Spare Parts Qty.
I		screw M8*30	4	1
J		washer for M8	4	1
K		spring washer for M8	4	1
L		nut for M8	4	1
M		Screw cap	4	1
N		allen key for M8	1	0
O		Spanner for M8	1	0
P				

Step1

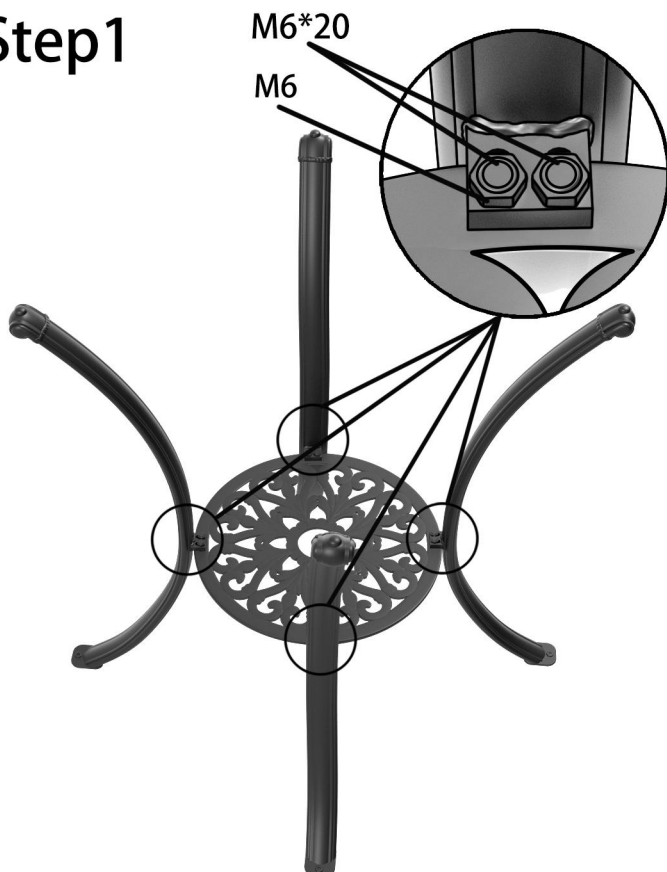

Step2

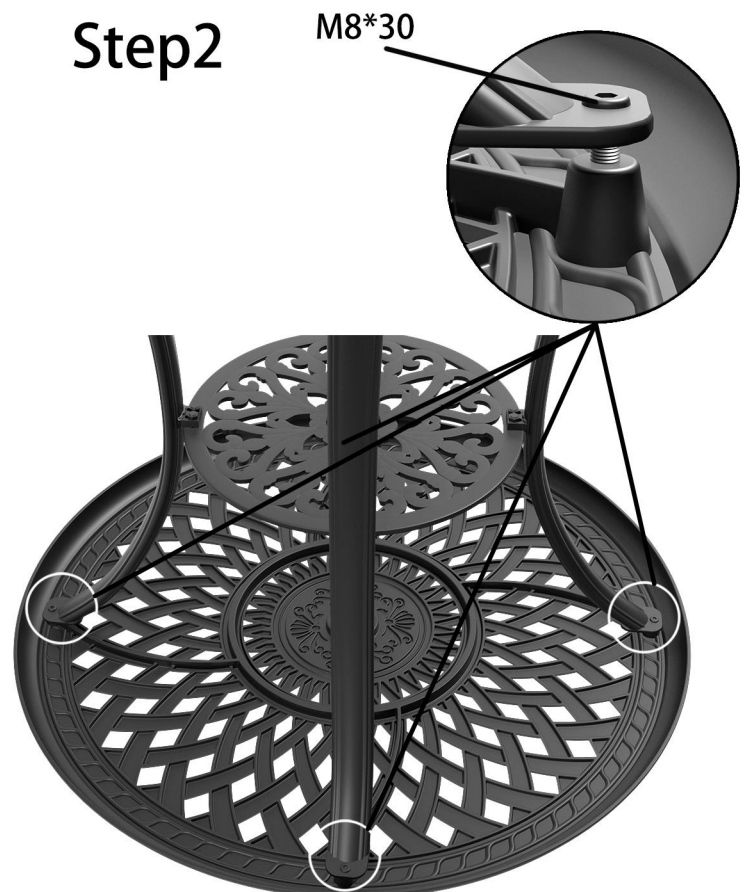

ASSEMBLY INSTRUCTION:

1.Initial Tightening

Use a hex key (Allen wrench), not a power drill, to tighten each screw to about 50% before fully securing any of them. Fully tightening one screw too early may cause others to misalign.

2.Final Tightening

Once all parts are aligned, gradually and evenly tighten all screws using the proper tools.







3.Misalignment Fix



If some screws don't line up, loosen all screws to 50%, adjust the parts, and try again.

4.Stability Issue

If the item feels unstable, loosen all screws, adjust it on a flat surface, then retighten them evenly.

Hardware Fittings

Item No.	Reference Image	Description	Qty.	Extra Spare Parts Qty.
A		screw M8*20	6	1
B		screw M6*15	4	1
C		spring washer for M6	4	1
D		spring washer for M8	6	1
E		washer for M6	4	1
F		washer for M8	6	1
G		Screw cap	10	1

Item No.	Reference Image	Description	Qty.	Extra Spare Parts Qty.
H		allen key for M8	1	0
I		allen key for M6	1	0
J				
K				
L				
M				
N				

Step1

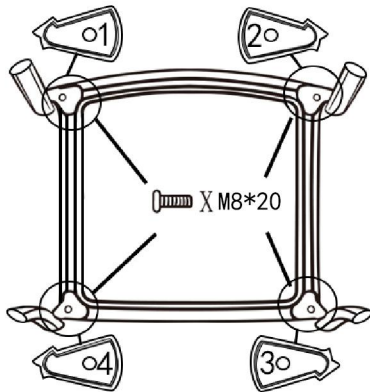

Step2

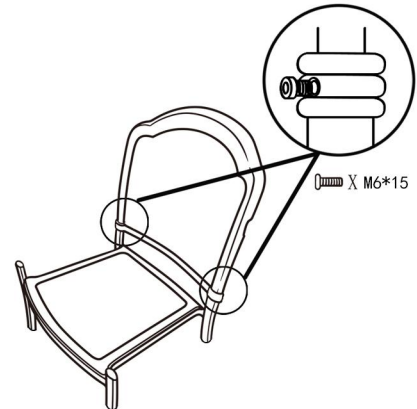

Step3

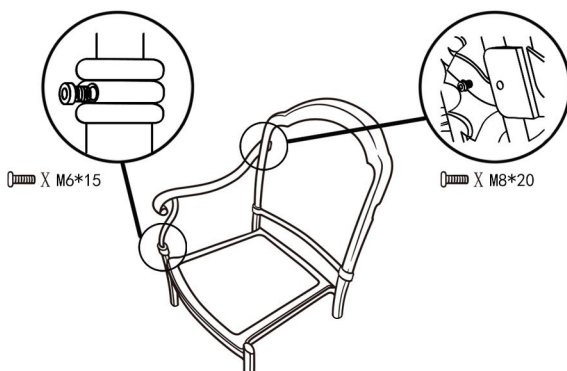

Step4

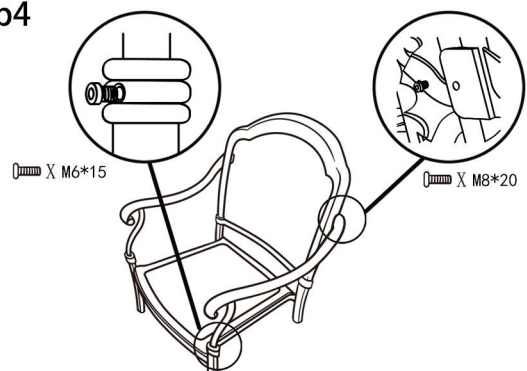

Part List



A.
Bracket
1 pc.



B.
Connector
1 pc.

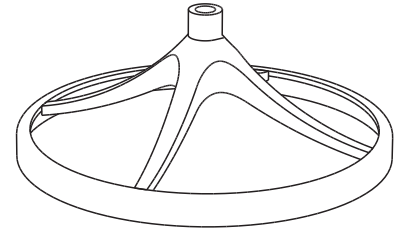

C.
Base
1 pc.

Hardware List

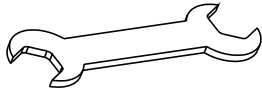

Spanner
1 pc

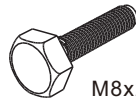

M8x20
Bolt
4 pcs



Flat Washer
4 pcs



Spring Washer
8 pcs



Flat Washer
2 pcs



M8x35
Bolt
4 pcs

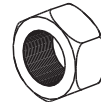

Nut
4 pcs

Assembly Instructions 1/2

IMPORTANT

- Use a soft cloth between these parts and the floor.
- Do not use power tools above 8 volts to assemble.
- Do not tighten all the bolts until each part is properly assembled.
- The unit must be level to work properly. Use the included adjustable levelers to level.
- Keep Wrench as the bolts may need to be tightened in the future.

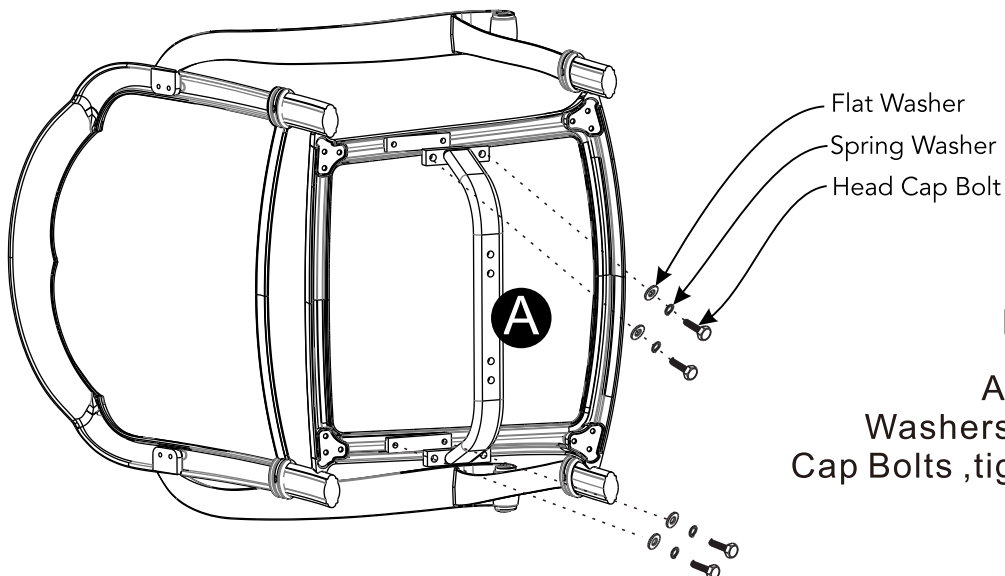

STEP 1

Place frame on a soft cloth.

Attach unit to Frame with Flat Washers , Spring Washers and Head Cap Bolts ,tightening bolts only halfway .

Tighten all Bolts .

STEP 2

Attach unit to Connector (B) with Bolts, Flat Washers, Spring Washers and Nuts, tightening bolts and nuts only halfway. (See Figure 1)

Tighten all Bolts and Nuts.

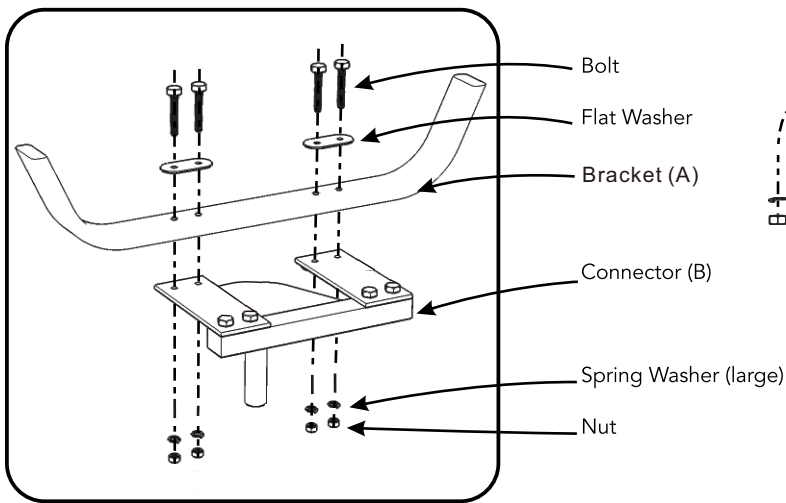
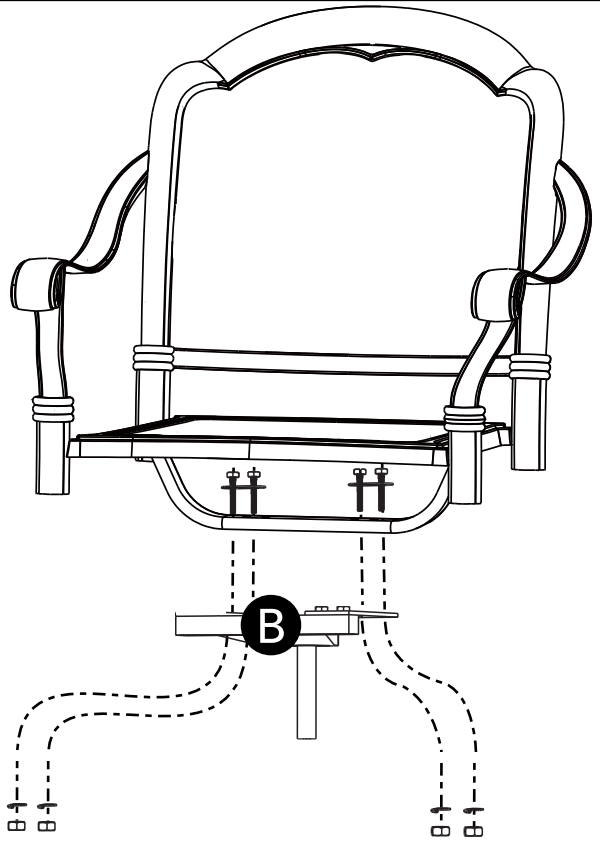
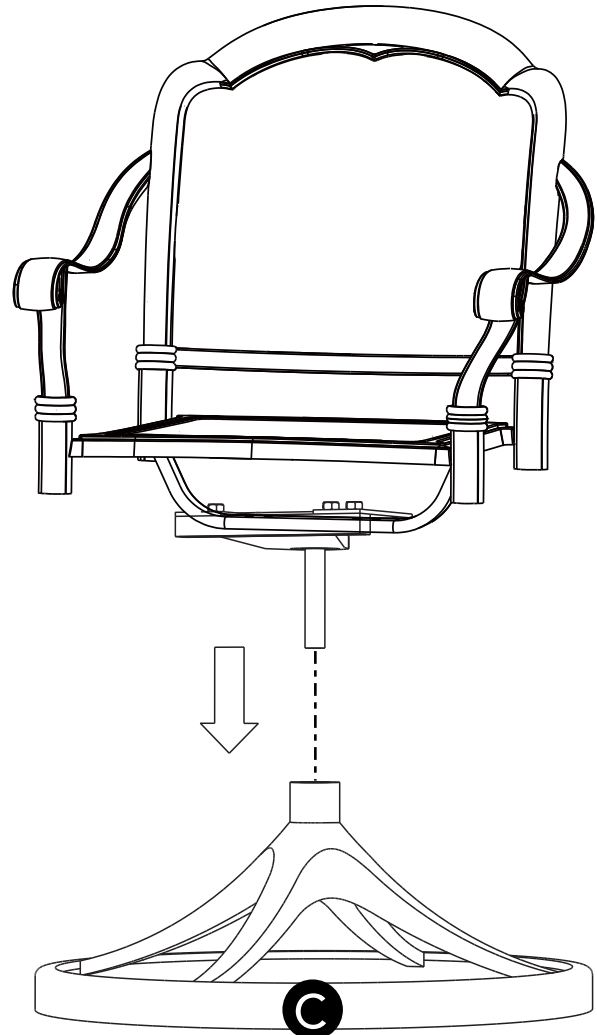

Figure 1



STEP 3

Place unit onto Base (C).