

# STU8623



Product family	Dishwashers
Width	24"
Commercial height	86 cm
Installation	Fully-integrated built-in
N° baskets	3, FlexiDuo
EAN code	8017709303648



## Programs



Number of programs	10	Delicates	Yes
Washing temperatures	38, 45, 50, 55, 65, 70, 75 °F	Normal	Yes
Soak	Yes	Crystal & China	Yes
Express 27'	Yes	Eco express	Yes
Mix	Yes	Express 60'	Yes
Sterilize	Yes	Pots & Pans	Yes

## Options



Dry Assist option	Yes	FlexiZone half-load option	Yes
Delay start	Up to 9 hours	Special programs option	Yes

## Baskets



Basket color	Gray	Lower basket	With 2 foldable racks
Upper basket	1 foldable rack	Largest loadable dish in lower basket	35,0 inches
Upper basket height adjustment	On 3 levels	Colour Inner Components	Blue
Sliding Guides Extra Glide	Yes	Cutlery basket	Yes
Largest loadable dish in upper basket	18,0 inches		

## Technical Features



<b>Width</b>	23 9/16 "	<b>Max water hardness</b>	100°FH;58°dH
<b>Depth</b>	21 5/8 "	<b>Drying system</b>	Natural condenser drying, with Dry Assist automatic door opening system at the end of the cycle
<b>Display type</b>	LED display (3 digits)	<b>Tub material</b>	Stainless steel
<b>Height</b>	33 3/4 "	<b>Filter</b>	Stainless steel
<b>Display</b>	Delay start, Program progress indicator, Time-to-end indicator	<b>Concealed heating element</b>	Yes
<b>Program symbols</b>	Symbols	<b>Hinges</b>	Self-balancing with variable hinges
<b>Salt indicator</b>	Light	<b>Min. and max. frontal panel weight</b>	4.4 - 19.8 lbs
<b>Rinse aid indicator</b>	Light	<b>Min. and max plinth height</b>	4" - 9"
<b>End-of-cycle indicator</b>	Light on display, with acoustic signal	<b>Adjustable feet</b>	2 3/4", from 33 7/8" to 36 5/8"
<b>Washing system</b>	Orbital	<b>Additional gaskets</b>	Yes
<b>Third spray arm</b>	Single	<b>Back cover</b>	Yes
<b>Water softener</b>	With electronic setting	<b>Depth of dishwasher with open door (mm)</b>	1186
<b>Flood protection system</b>	Single AquaStop	<b>Top cover</b>	Metal sheet

## Electrical Connection

<b>Plug</b>	(A) USA & Mexico	<b>Frequency (Hz)</b>	60 Hz
<b>Connected power</b>	1800 W	<b>Connection type</b>	Single-phase
<b>Current</b>	13 A	<b>Power supply cable length</b>	140 "
<b>Voltage</b>	115 V		

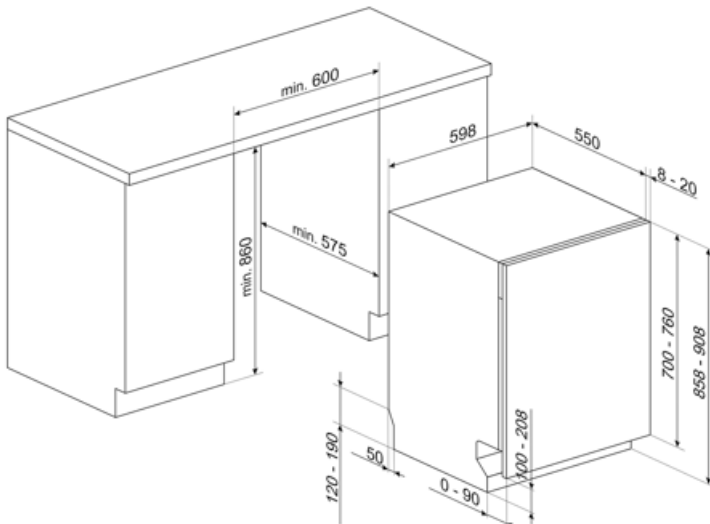

## Compatible Accessories



### KIT86CX-1

Door kit, stainless steel, Canali handle, fully integrated dishwasher h.86 cm  
Compatible with models with Flexifit and fixed fulcrum hinges.



### KIT86VX

stainless steel panel with Victoria handle. Can be fitted on the fully integrated dishwashers H86 with no Flexifit hinges. It is not possible to install it on the models with stainless steel panel

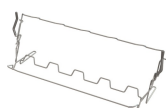

### KITGH

Kit glass holder. It has to be fitted on the first basket but only if there are foldable racks



### KITPL60B

Toekick Kit in White colour with adjustable height and deepness. Can be installed over all the fully integrated and underbench models with variable fulcrum or flexifit hinges.



### KITPL60N

Toekick Kit in Black colour with adjustable height and deepness. Can be installed over all the fully integrated and underbench models with variable fulcrum or flexifit hinges.



### KITPL60X

















Toekick Kit in Stainless Steel with adjustable height and deepness. Can be fitted over all the fully integrated and underbench models with variable fulcrum or flexifit hinges.



### KITPLV2

Kit extension for dishwasher and washing machine: lenght mt. 2

## Symbols glossary

 <p>Acquastop: Some Smeg dishwashers are equipped with a simple Acquastop: float sensor in the bottom which is necessary to prevent an accidental leakage of water inside the appliance.</p>	 <p>COMM_HEIGHT_86_72dpi</p>
 <p>Delay Timer: The delay timer can postpone the start of the program by up to 24 hours.</p>	 <p>Enersave: At the end of the drying cycle a special device slowly automatically opens the door a few centimeters, to ensure perfect drying and to save up to 20% of energy on some models.</p>
 <p>FlexiDuo: The FlexiDuo 3rd cutlery basket allows you to arrange cutlery or small cups, ladles, or bulky utensils however you like: it consists of two separate and moveable modules.</p>	 <p>FlexiZone: The ½ load flexizone allows you to wash a reduced load saving energy, water and time and there are no restrictions on where the items are placed.</p>
 <p>The new ExtraGlide guide system, available on top of the range models, makes the second basket even smoother and softer. In fact, it facilitates the extraction of the introduction, even at full load and, for the greater excursion, the insertion of crockery is also facilitated in the rear part.</p>	 <p>Noise Level: Excellent insulation and special devices keep noise to a minimum.</p>
 <p>Orbital wash system distributes water evenly throughout the 60cm dishwasher cavity, directing water with precision to ensure an excellent wash.</p>	 <p>Delicate: Delicate washing program is designed for delicate dishes which are not heavily soiled.</p>
 <p>Normal programme: The normal programme is suitable for normal degrees of dirt for everyday use.</p>	 <p>...</p>
 <p>Soak programme: The soak programme provides a rinse to prevent dirt from drying.</p>	 <p>Rapid 27 Mins: The rapid 27 mins quick program takes just 27 minutes to wash a load.</p>
 <p>The symbols show the number of plate settings of the dishwasher.</p>	 <p>System WaterSave ensures the best washing results with minimal water consumption depending on the model of dishwasher.</p>
 <p>...</p>	

## Benefit (TT)

---

### **FlexiDuo**

The flexible third basket provides additional space, adapting to the load to accommodate various types of dishes, ensuring optimal organization and efficient use of interior capacity

The third FlexiDuo basket consists of two separate sections that can be handled independently of each other, stacked and/or removed, offering loading flexibility for every need. Depending on the arrangement, it allows cups, tall glasses, bulky utensils and pots and pans to be placed in the upper basket.

### **Orbital Wash System**

Even water distribution, deep cleaning and low noise thanks to the dual rotating spray arms

Orbital washing system, which, thanks to its double arm, its 7 water exit points and thanks to overlapping and simultaneous rotations and 40 rotations per minute, allows ample coverage of the tank area, thus guaranteeing optimal results in any basket-loading configuration.

### **Extra Glide Telescopic Guides**

Smoother and more stable loading and unloading operations

Extra Glide telescopic guides ensure smooth and safe extraction of the upper basket, even with heavy loads. The telescopic design ensures smooth, stable and silent movement, improving ergonomics and convenience. Ideal for optimising space and ease of use, they combine durability and comfort in every washing operation.