

ITEM: 905633

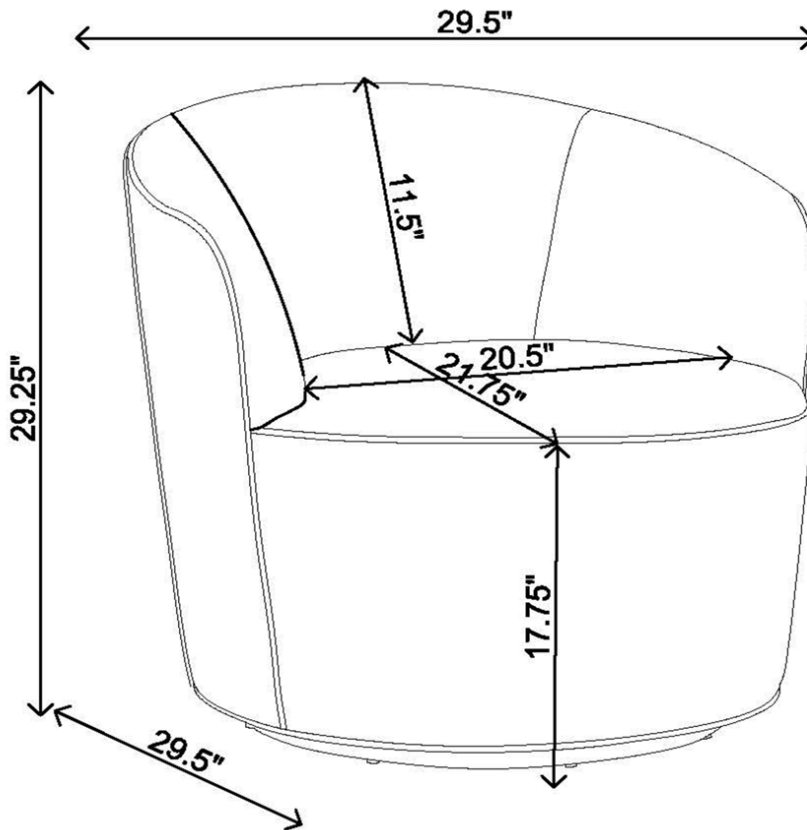

Note : Dimension tolerance $\pm 5\%$