

ASSEMBLY INSTRUCTIONS

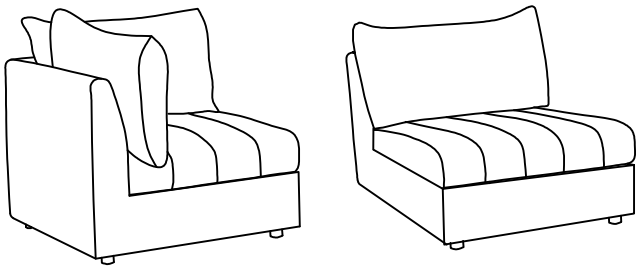

+ Do Not Use Power Tools



+ Suggested Adults



NOTE:

- 1 Read instructions cover to cover.
- 2 Save all packaging until assembly is completed.

1 IMPORTANT SAFETY INFORMATION

Do not assemble the product if any of the following parts arrived damaged:

- | | |
|--------|------------------------------|
| part # | - Corner base |
| part # | - Corner seat cushion |
| part # | - Armless chair base |
| part # | - Armless chair seat cushion |
| part # | - Corner back cushion |
| part # | - Armless back cushion |
| part # | - Leg |

Do not assemble if any of the following Hardware parts are missing:

- | | |
|--------|-----------------------|
| part # | - Allen wrench |
| part # | - Bolt M8"*35mm |
| part # | - Washer M8*16mm |
| part # | - Connect metal plate |

2 IMPORTANT ASSEMBLY INFORMATION

Assembly Step If loosening persists, please make sure to tighten all the bolts periodically, or use a thread locker adhesive.

+ Parts Included

- | | |
|----------------------|------------------------------|
| ① Corner base
1pc | ② Corner seat cushion
1pc |
|----------------------|------------------------------|

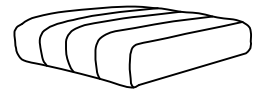
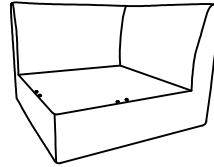

- | | |
|-----------------------------|-------------------------------------|
| ③ Armless chair base
1pc | ④ Armless chair seat cushion
1pc |
|-----------------------------|-------------------------------------|

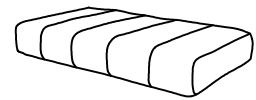
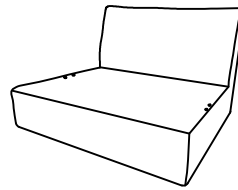

- | | |
|-------------------------------|-------------------------------|
| ⑤ Corner back cushion
2pcs | ⑥ Armless back cushion
1pc |
|-------------------------------|-------------------------------|

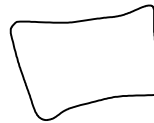

- ⑦ Leg
8pcs



+ Hardware Included

- A** Allen wrench
1pc



- B** Bolt M8"*35mm
8pcs



- C** Washer M8*16mm
8 pcs



- D** Connect metal plate
100*75*18mm
2 pcs

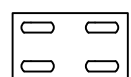

ASSEMBLY INSTRUCTIONS

1

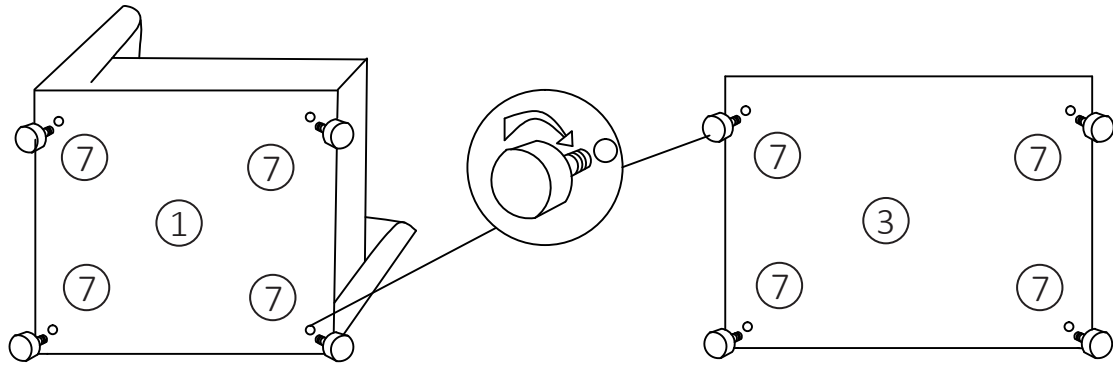

2

Remove the cushions from each product.

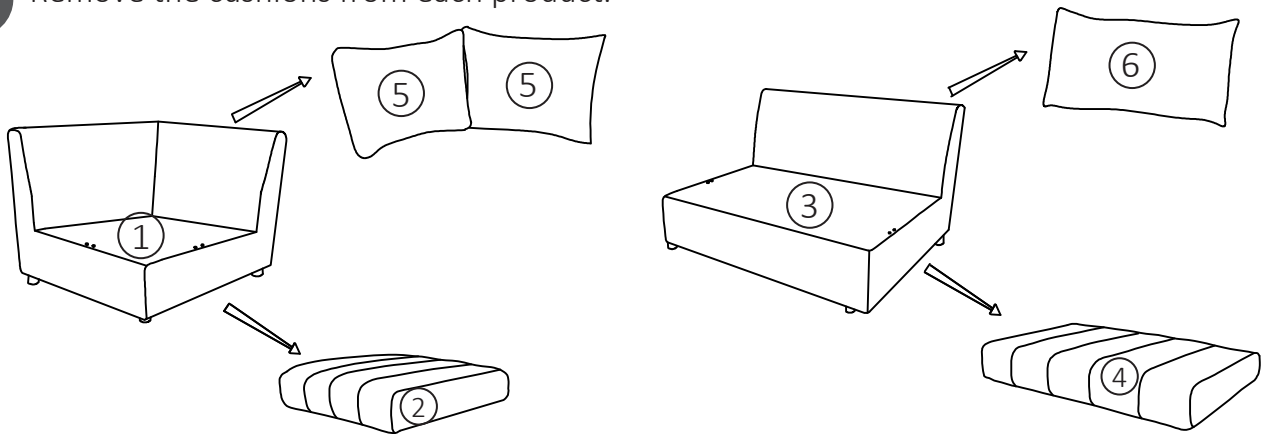

3

Assemble connect metal plate, then put cushions back on the seat.

