



INSTURCTION MANUAL

ASSEMBLY GUIDE

Before enjoy the comfort chair, you have to put it together. This Assembly Guide will take you through the basic assembly process. To make sure your assembly goes smoothly, please follow the assembly instructions, **and especially the important safety information.**

Also, while it is possible to assemble the chair on your own, **having a second person to help you makes it even easier.**

Before you begin, please check if there are any missing parts from the package. Should there be any issues, please don't hesitate to drop us an email and we'll help you out ASAP.

If you run into any difficulty during the assembly, remember to check out the Assembly Video to see if you've missed anything. If you're unable to resolve your problems, drop us an email as well and our support team will assist you.

PACKAGE LIST

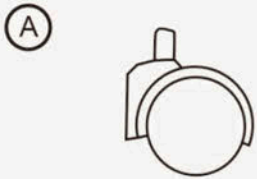

Casters

Quantity: 5

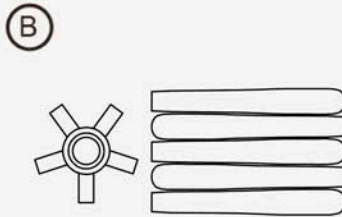

Star Base

Quantity: 1

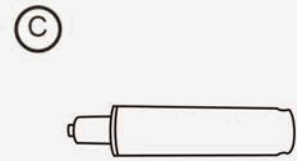

Gas Lift

Quantity: 1

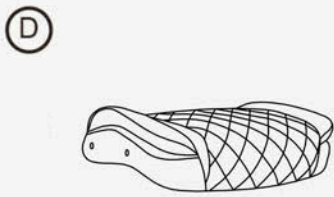

Seat Cushion

Quantity: 1

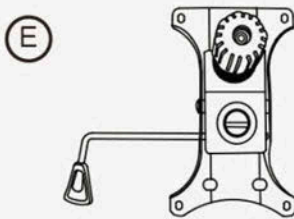

Seat Plate

Quantity: 1

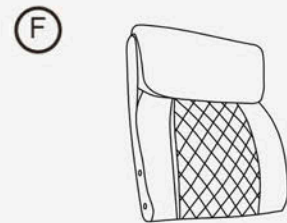

Back Cushion

Quantity: 1

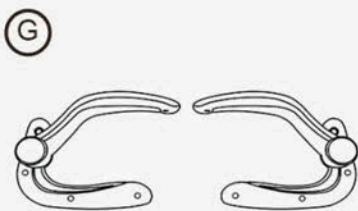

Arms

Quantity: 2

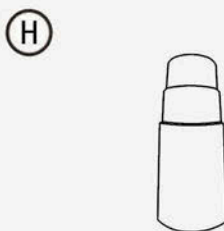

Gaslift cover

Quantity: 1

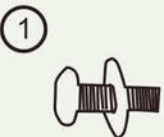

Bolts M6*25mm

Quantity: 4

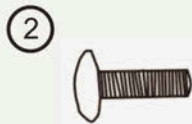

Bolts M6*35mm

Quantity: 8

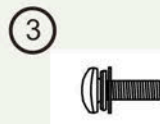

Bolts M6*20mm

Quantity: 10

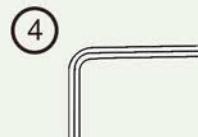

Wrench

Quantity: 1

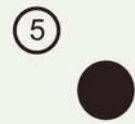

Plastic Caps

Quantity: 8



Matching Drill

Quantity: 1

ASSEMBLY INSTRUCTION

If possible , using the gift accessories NO.5 with your electric drill to install our chair will make assembly more convenient .

STEP 1 : Open the backrest and take out the accessories

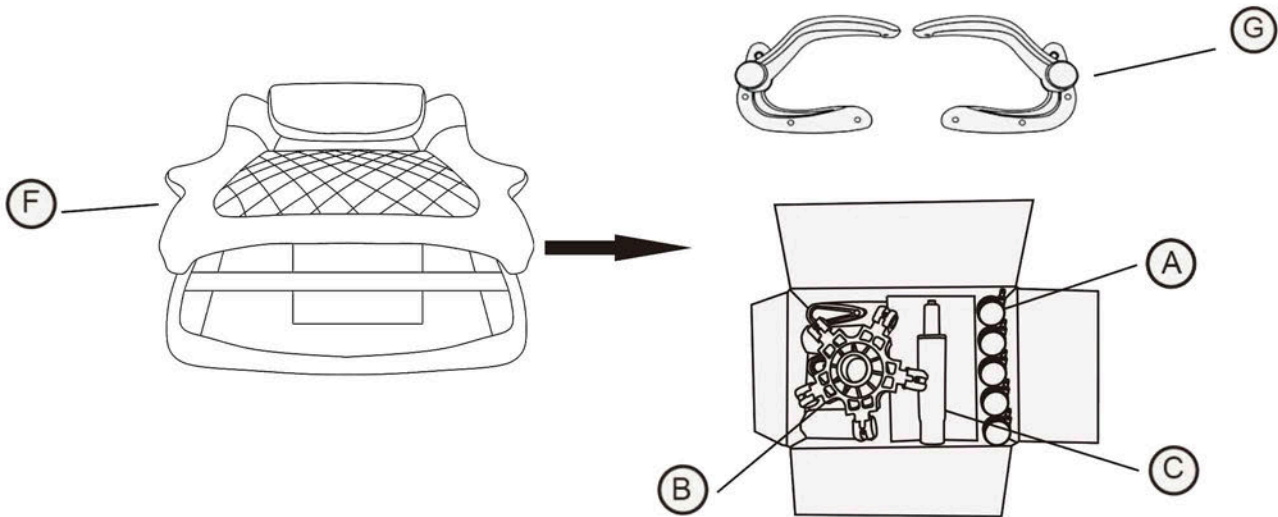

STEP 2 : Turn the Star Base upside down, then press the Casters into the holes at the end of each base leg.

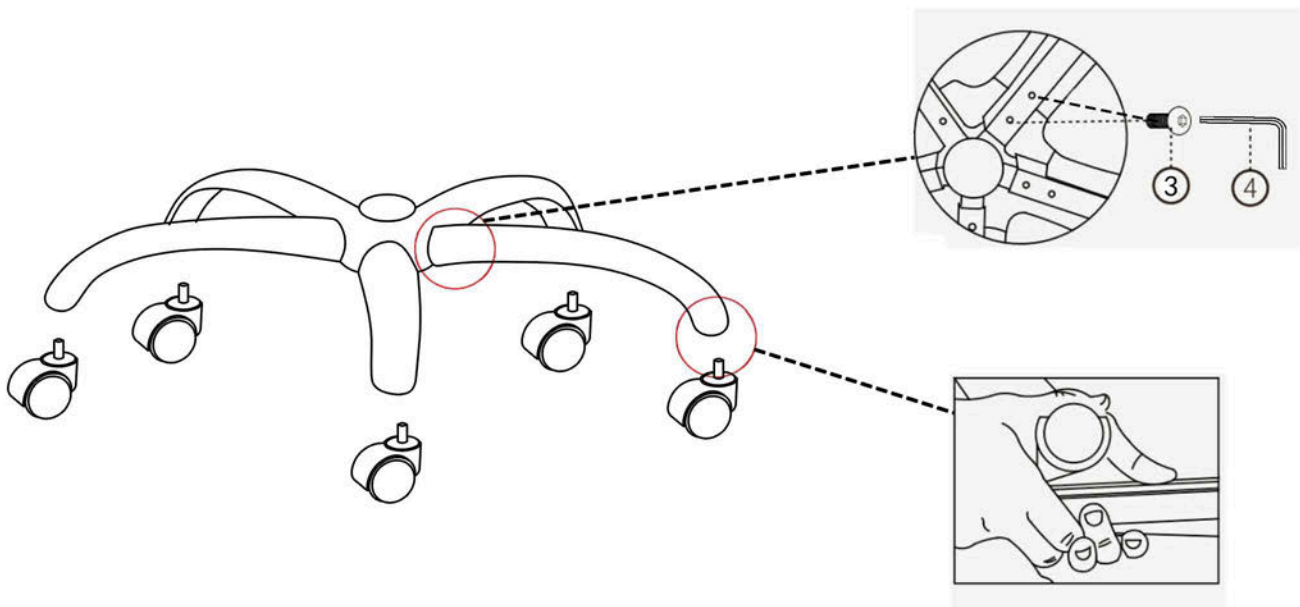

STEP 3 : Turn the Star Base upright and insert the Lift into the center hole of the Star Base.

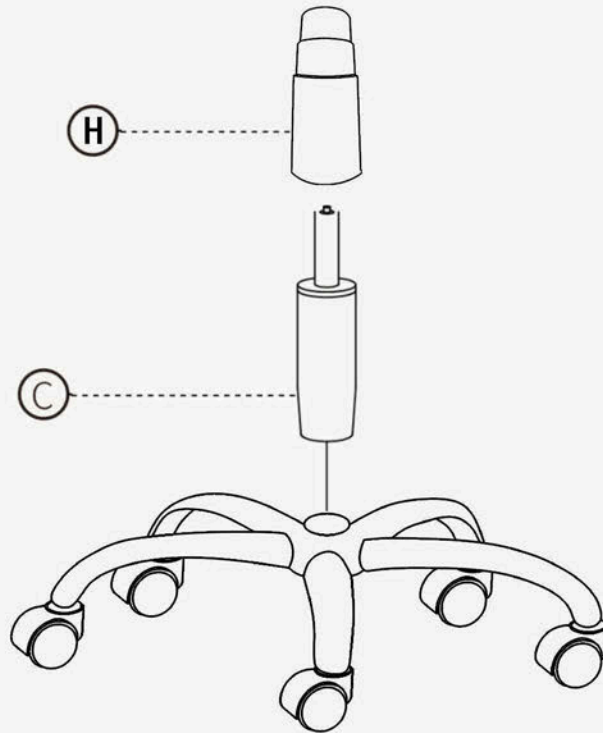

STEP 4 : Attach the arms to the seat cushion with four M6*35mm bolts, using the Wrench.

*Note: Arm rests are labeled with an "L" (left) or "R" (right) to show which sides they should be placed on.

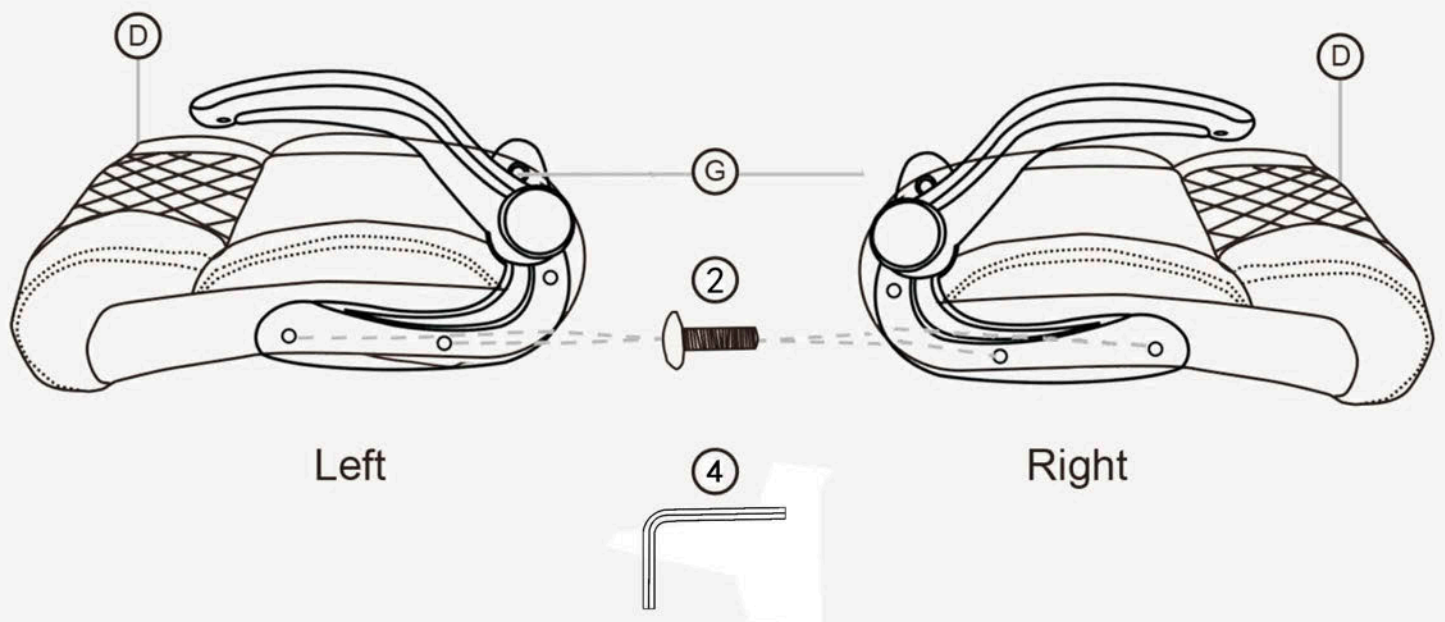

STEP 5 : Rotate the back of the chair up, then secure it with the top two M6*35mm bolts.

Note: Tighten bolts to 50%, DO NOT tighten fully at this step.

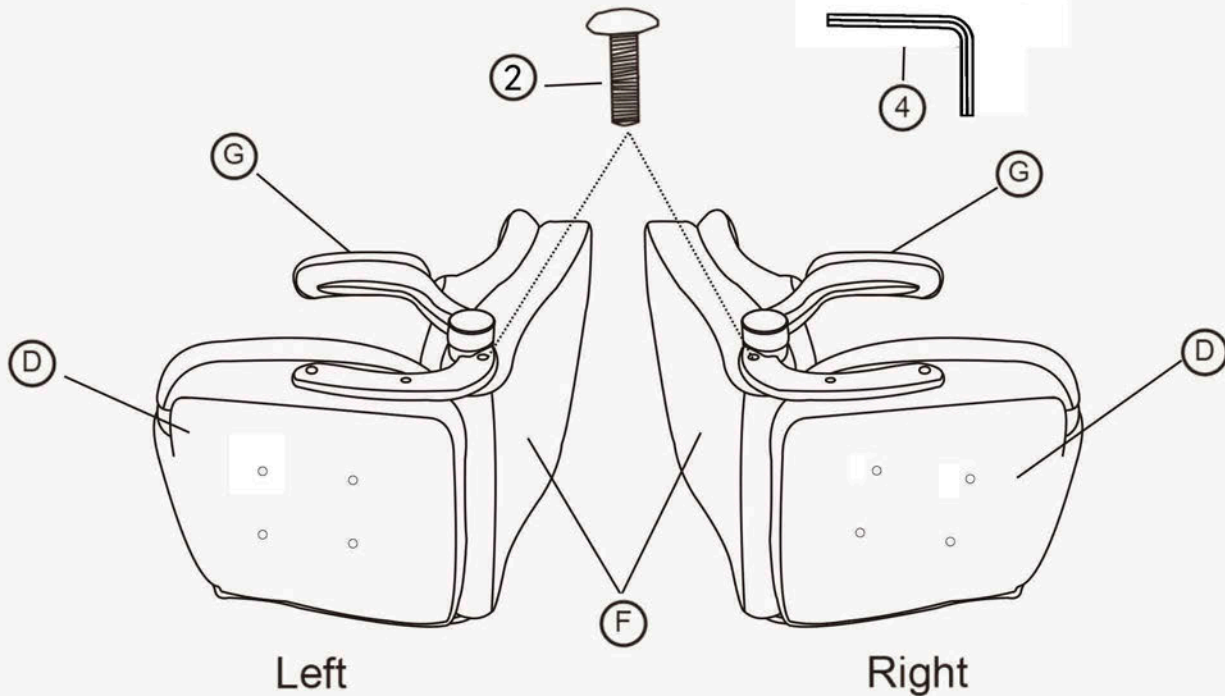

STEP 6: Align the seat plate to the bottom of the seat cushion, make sure that the front of the seat plate is facing the front of the seat cushion. Attach the seat plate to the seat cushion using four M6X25mm bolts, tighten all the bolts with the wrench.

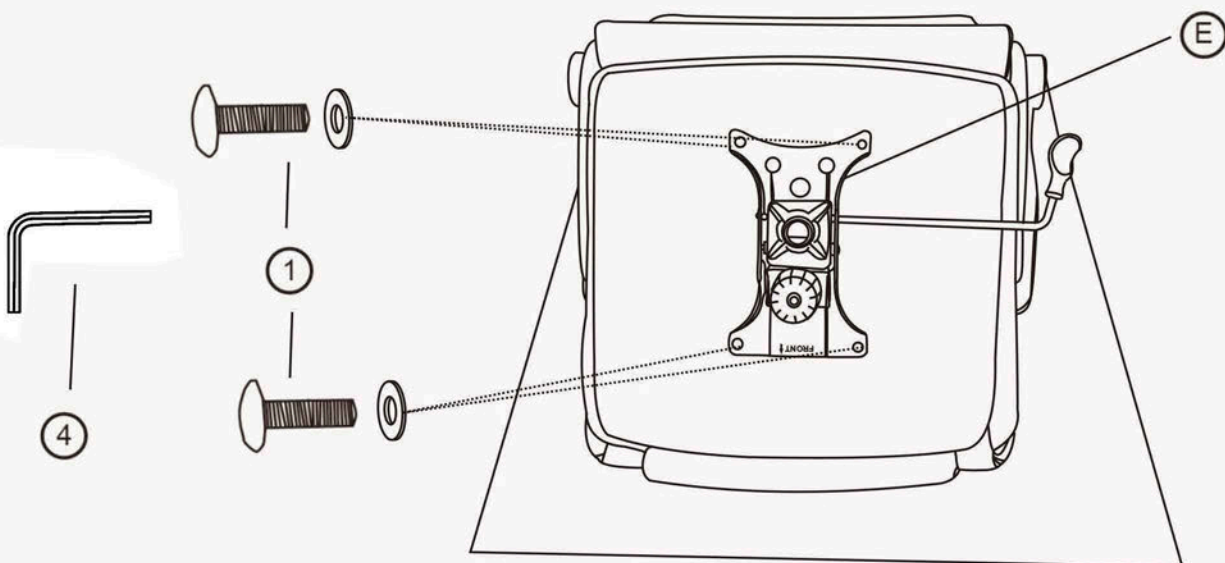

STEP 7: Turn the seat cushion upright and align the center hole of the seat plate over the lift, then push the seat cushion down onto the lift firmly until the connection is secure.

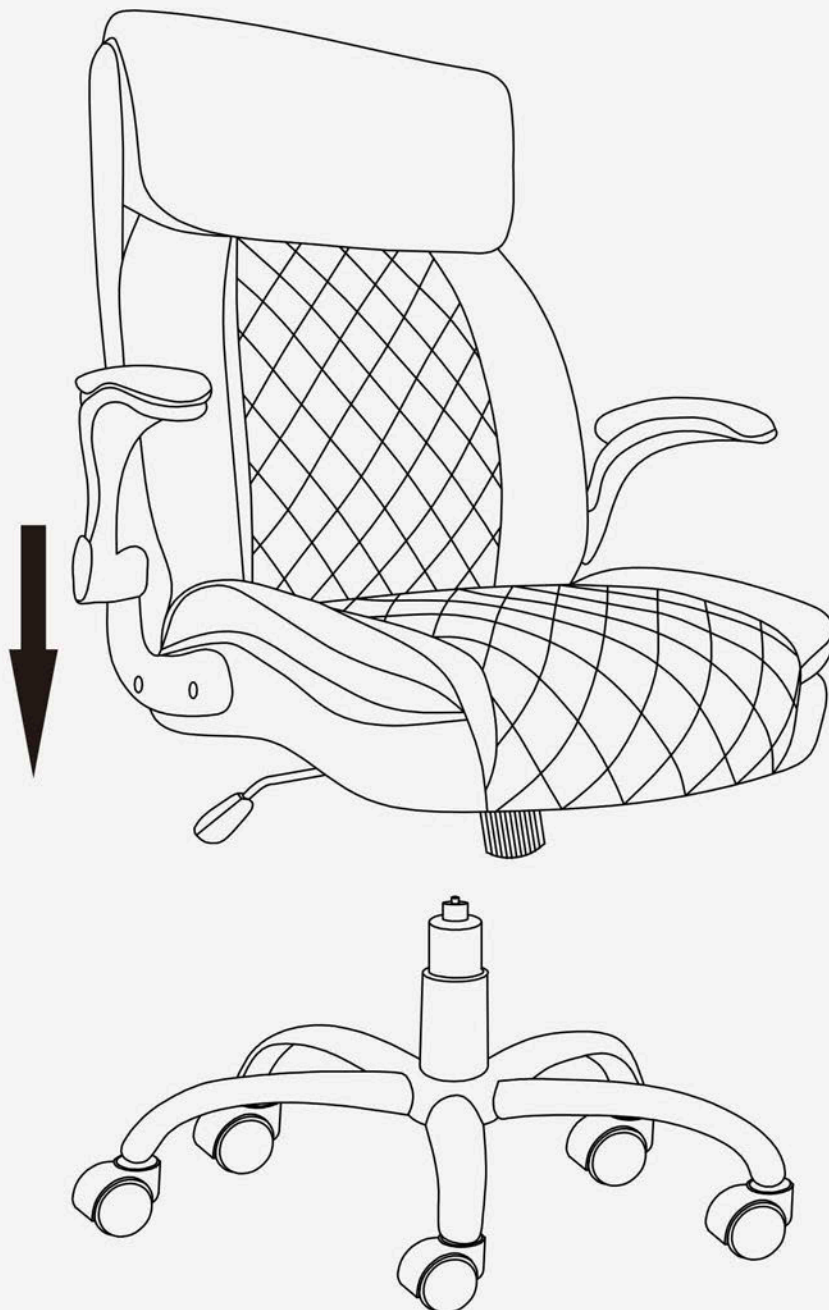

STEP 8: Adjust the balance first, then fully tighten all the bolts on each side.

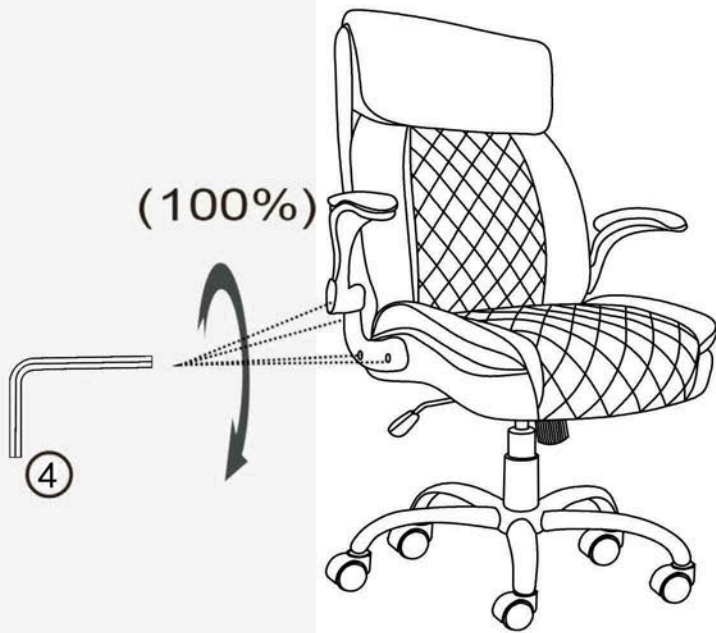

STEP 9 : Press the plastic caps into the armrest holes to cover the bolts.

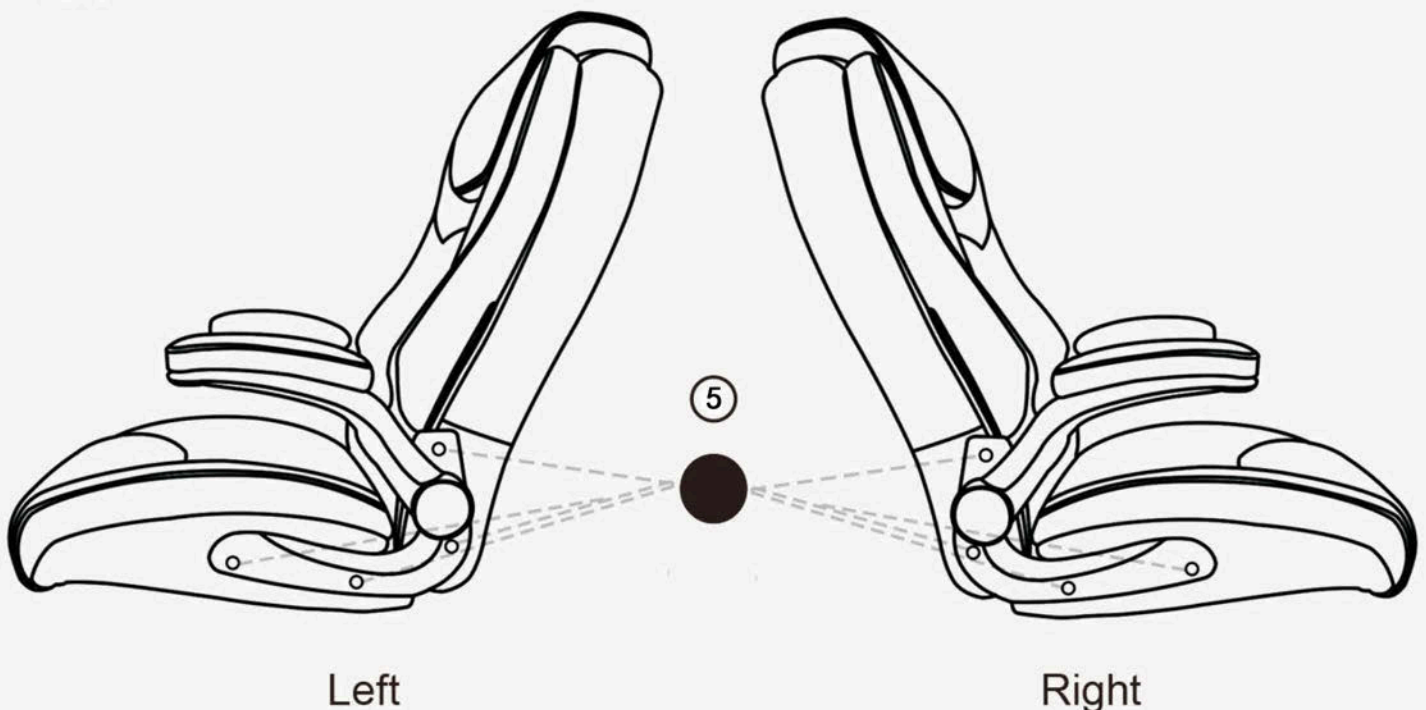



INSTRUCTIONS FOR USE

1. Seat Height: Paddle-shaped lever on the right side

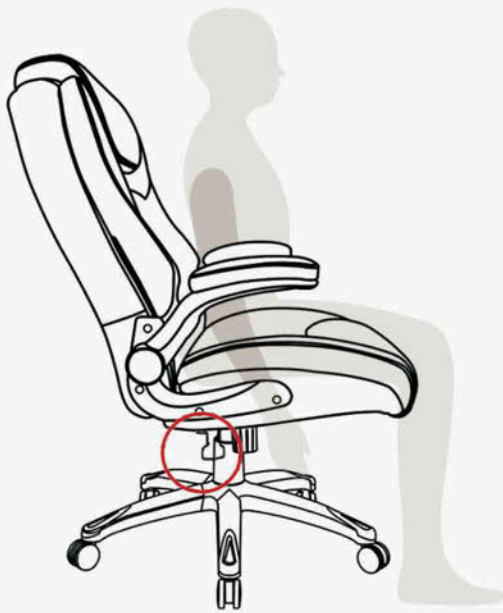

To raise:

While taking your weight off chair, lift lever up.



To lower:

While seated, lift lever up.

* At the proper height, your feet should rest flat on the floor.

2. Tilt Tension: Long stem under the seat cushion with knob

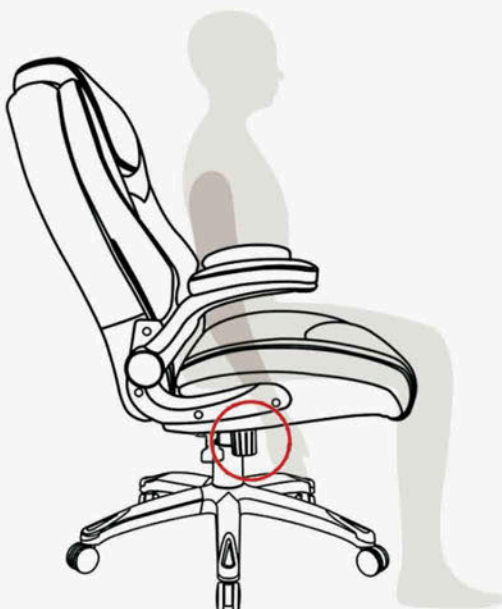

To increase tension:

While seated, turn knob forward (toward + sign).



To decrease tension:

While seated, turn knob backward (toward - sign).

* Set the tilt tension to control the resistance you feel when leaning back.

SAFETY AND MAINTENANCE

- Do not stand on the chair, Do Not use the chair as stepladder.
- Use this product for seating one person at a time.
- Do not use the chair unless all bolts and screws are firmly secured.
- Avoid contact with sharp objects to prevent puncturing the fabric.
- Every 6 months, check all bolts and screws to ensure they are tight.
- To clean, spot clean only using a damp towel and mild cleaner, first test on a small,, obscure area of fabric.
- Chair weight limit not to exceed 400 lbs.

SAFETY INFORMATION



Sit in the center of the chair, with your back to the backrest



Do not sit at the front edge of the chair



Do not stand on the chair



Do not use the chair with more than one person



Do not push the chair around when a person is sitting in it



Do not push down on the backrest when a person is reclined



Do not place all your weight on the backrest only

WARRANTY

We adopt a 30-day return policy, plus a 1-year warranty and permanent after-sales answers.

RETURN POLICY: We adopt a 30 days return policy which means that all products purchased on this website may be returned to us within the timeframe. You need to contact us within 30 days after the product(s) came into your possession and the product(s) must be returned to us without any undue delays. Returned products must be returned in the same condition as they were sent and they must be sent in its original packaging.

WARRANTY POLICY: [redacted] promises to repair any [redacted] chair that is found to be defective in material or workmanship within one (1) and year from the date of original purchase so long as you, the original purchaser, still owns it.

This warranty is subject to the provisions below.

EXCLUSIONS:

This warranty does not apply and no other warranty applies to:

- Normal wear and tear, which are to be expected over the course of ownership.
- Misuse, abuse or excessive use of the product.
- Modifications or attachments to the product that are not approved by Colerline
- Products that were not installed, used, or maintained in accordance with product instructions and warnings.
- Products used for rental or commercial purposes.
- Damage caused by the carrier in-transit is handled under separate terms.

Seating Usage: Normal use for seating is identified as the equivalent of a single shift, forty- (40) hour workweek. To the extent that a seating product is used in a manner exceeding this, the applicable warranty period will be reduced in a pro-rata manner.