

# ASSEMBLY INSTRUCTION

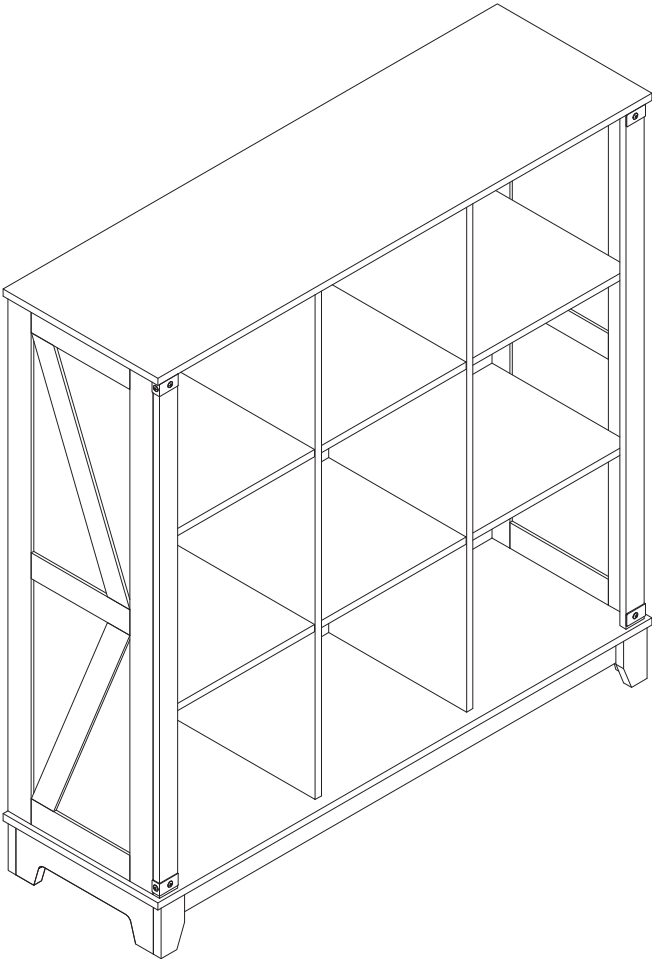

# Packaging Details

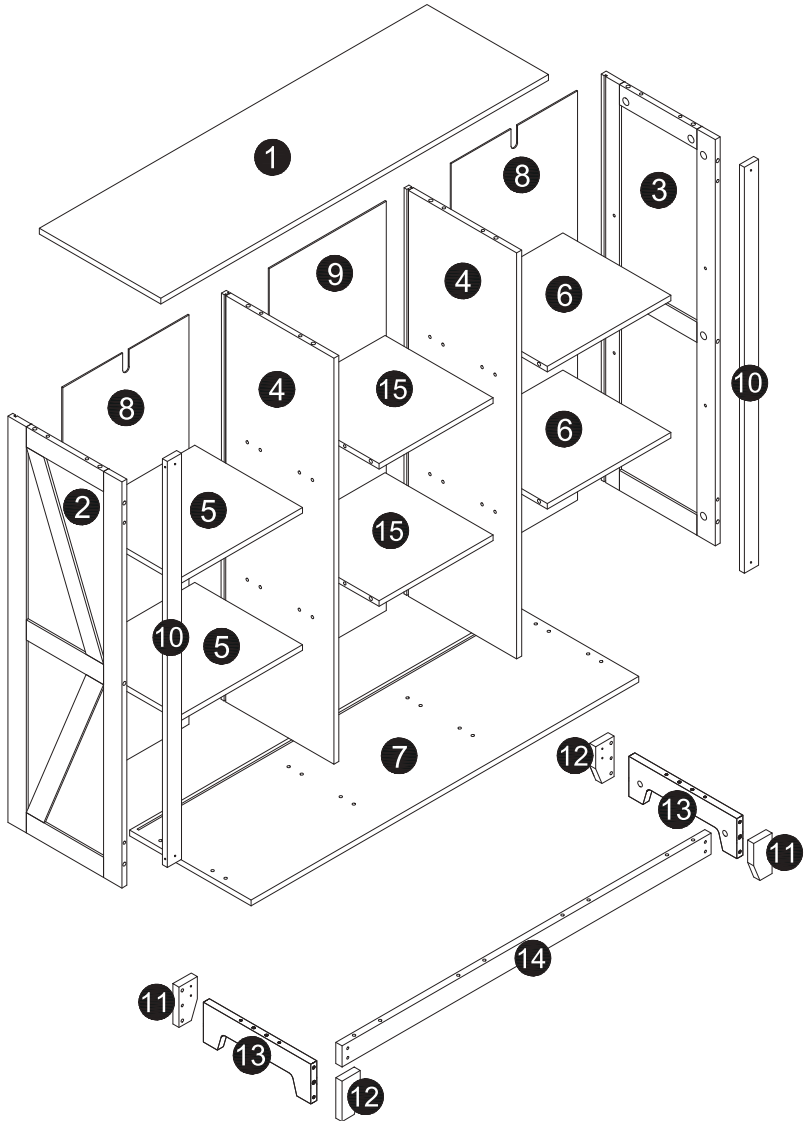

Please check all parts and accessories according to the parts list before assembling, make sure all contents are sufficient and in good condition.

If there is any parts missing or defective, please contact us immediately with purchase platform message to get replacement parts.

## PARTS:

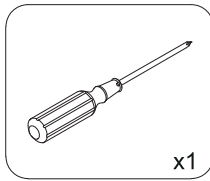
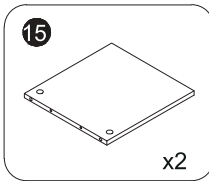
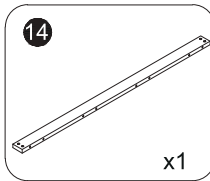
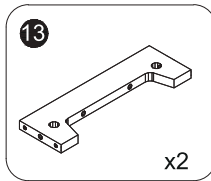
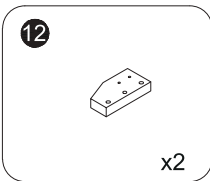
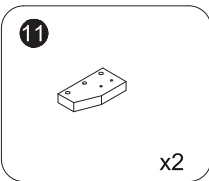
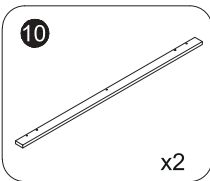
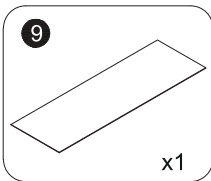
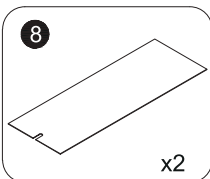
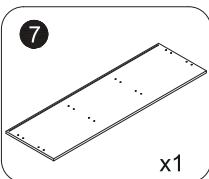
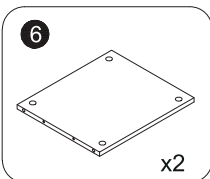
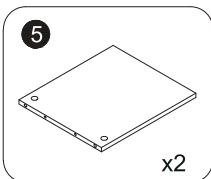
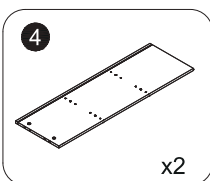
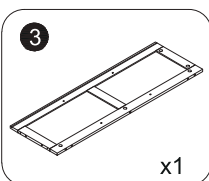
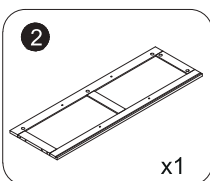
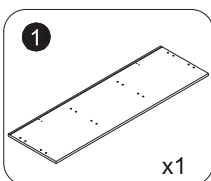

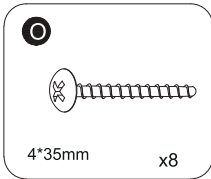
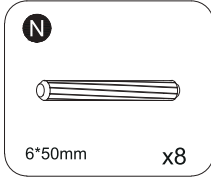
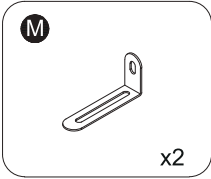
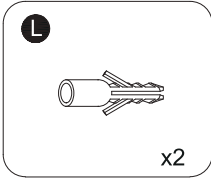
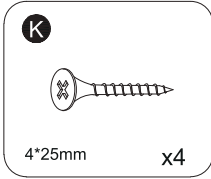
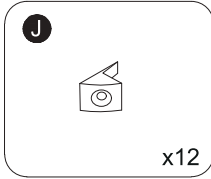
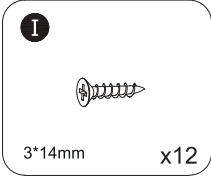
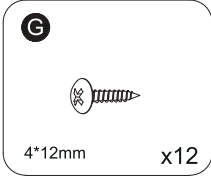
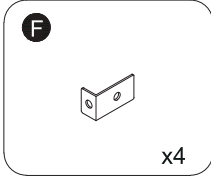
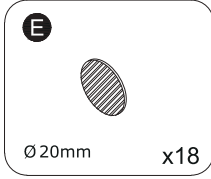
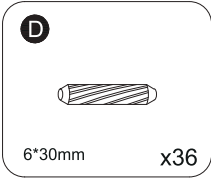
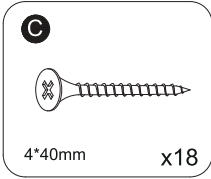
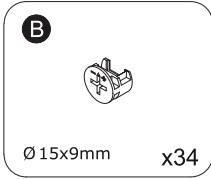
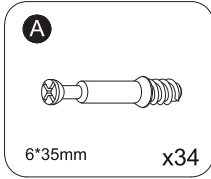

# HOW TO INSTALL

## NOTICE:

1. Use electric drill for easier installation experience.
2. Please drive the screws in pre-drilled holes.
3. Please strictly follow the instruction and diagram in every step.
4. Make sure every part is on the right position, otherwise it may cause unnecessary problem.
5. Select the proper component via the label on every part while assembling.

## REMARK:

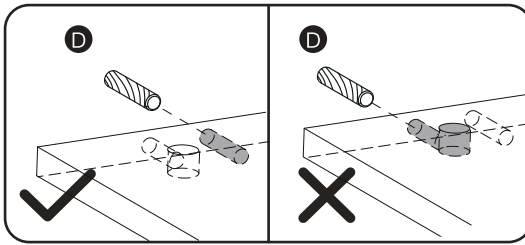

Avoid inserting part D into wrong holes.

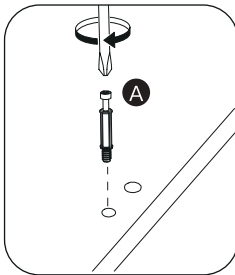

Part A must be installed into the holes with rubber nuts which are smaller than others.

Make sure that part A is facing the direction of part B opening.

When locking part B, please make sure part A is fully inserted.

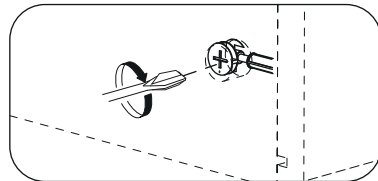
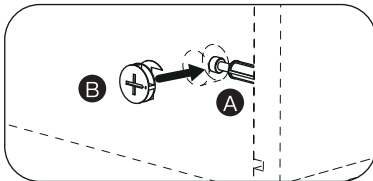

**Step 1** Insert part **N** into part **5** & **15**. Install part **A** on part **4**.

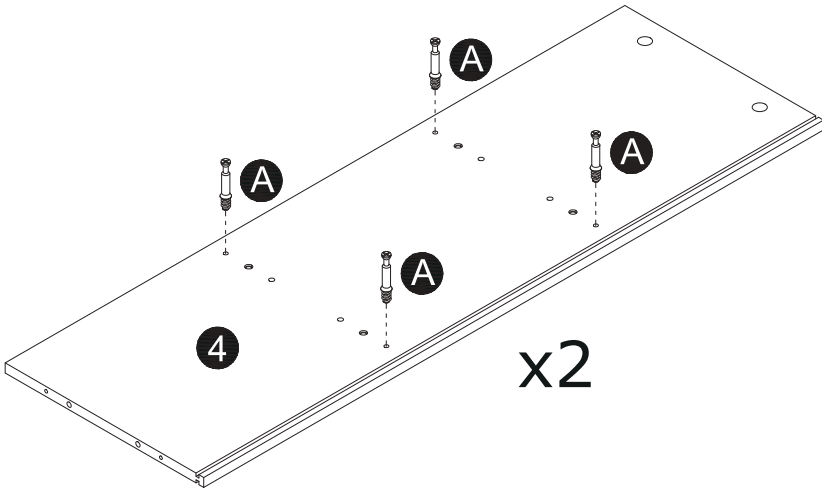
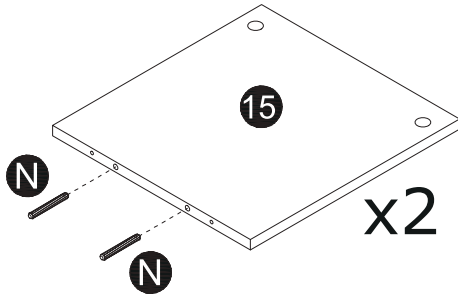
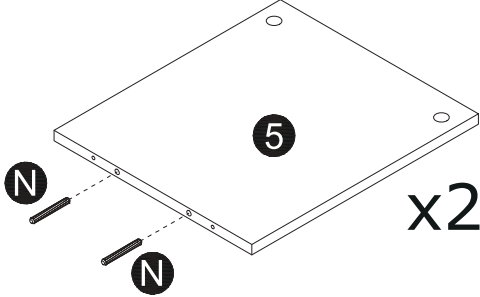
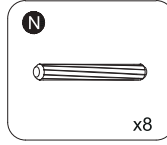
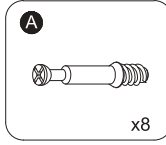
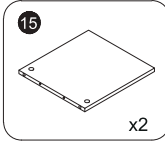
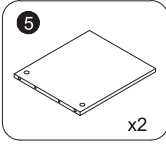
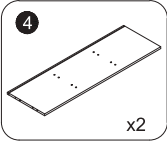

## Step 2

Install part **5** on part **4**, use part **C** to screw them.

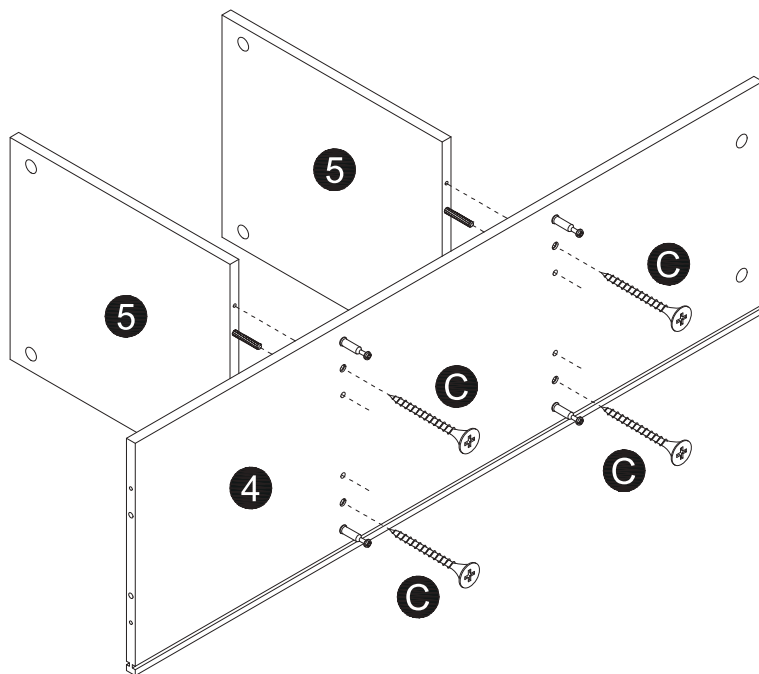
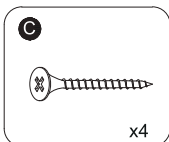

### Step 3

Install part 15 on part 4, use part B to screw them.

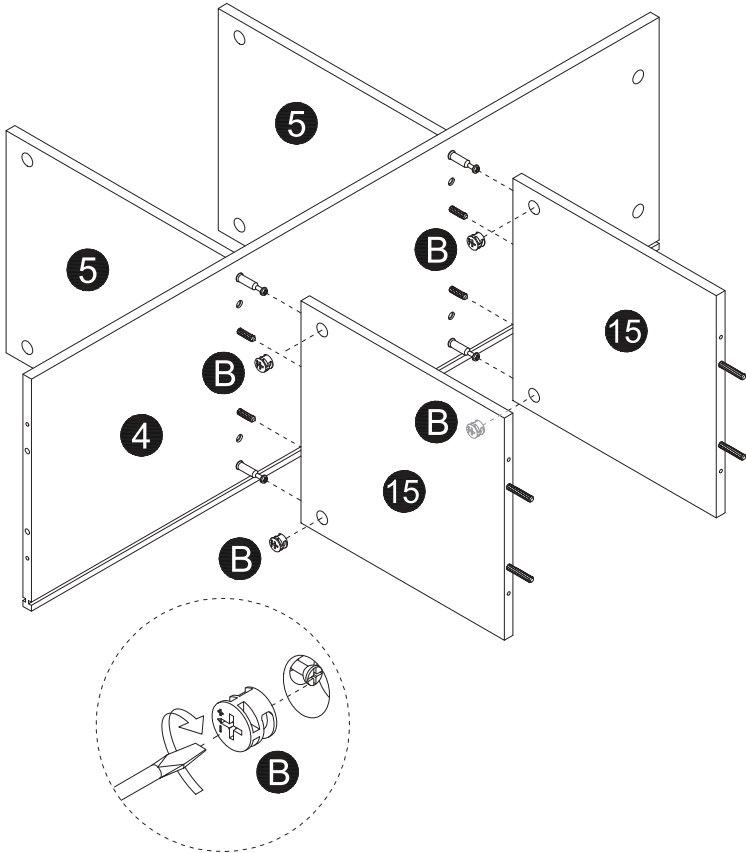
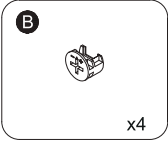

**Step 4** Install another part 4 on part 15, use part C to screw them.

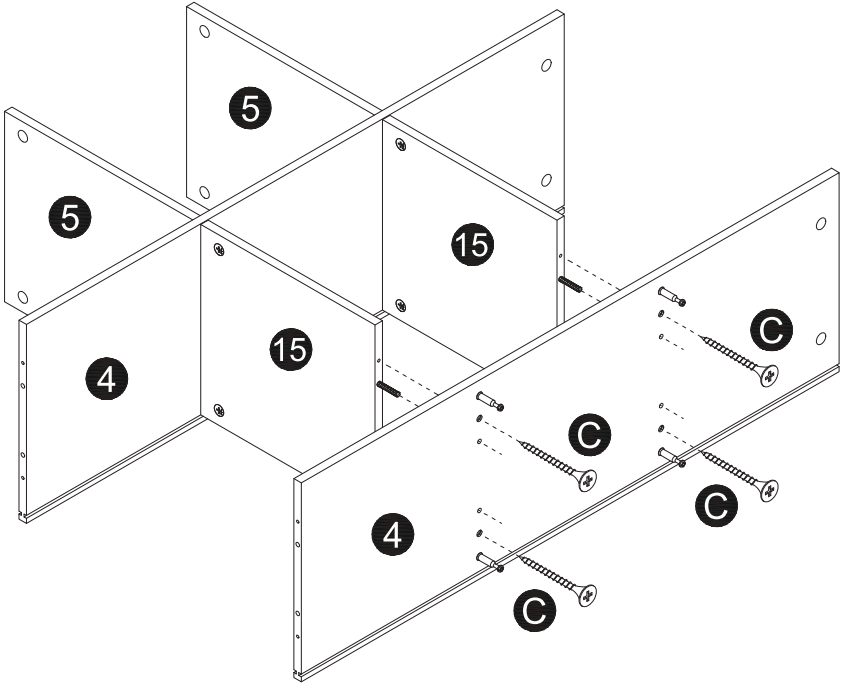
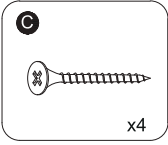

# Step 5

Install part 6 on part 4, use part B to screw them.

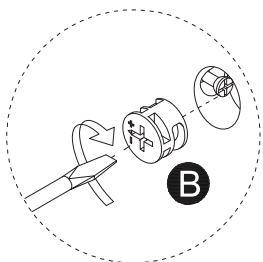
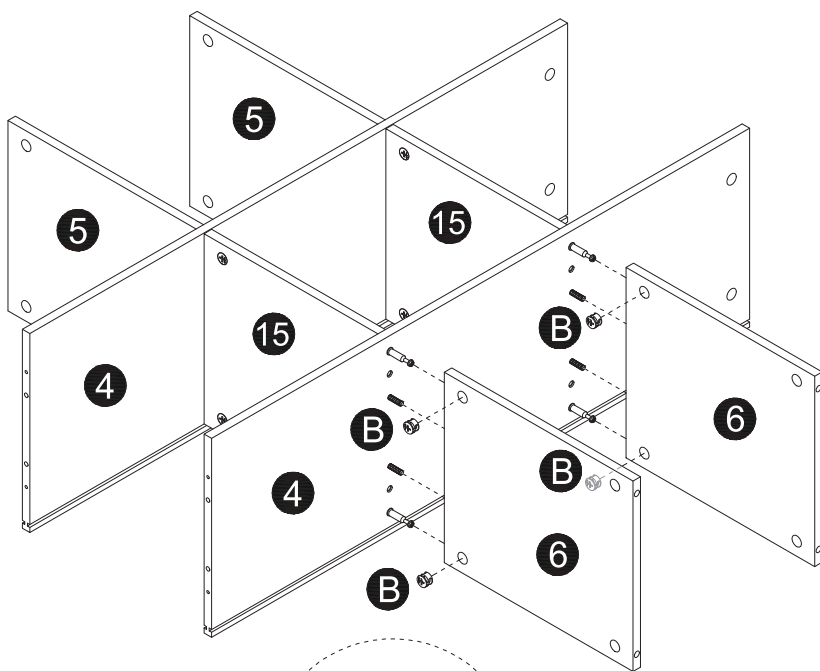
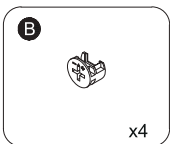
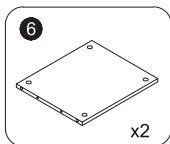

**Step 6** Install part **A** on part **2** & **3**.

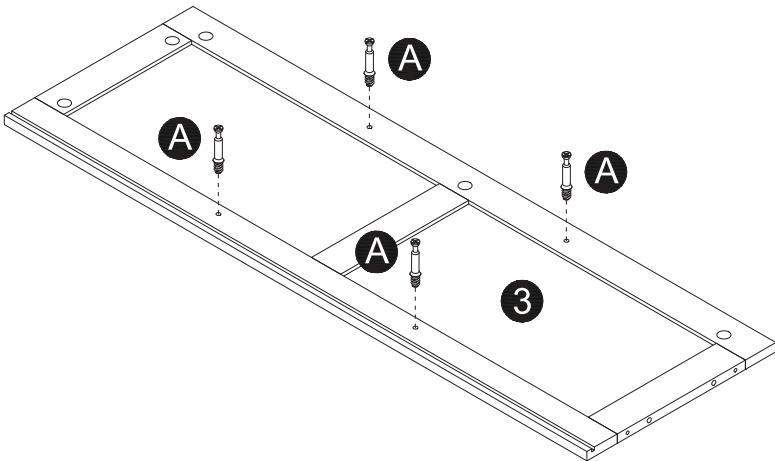
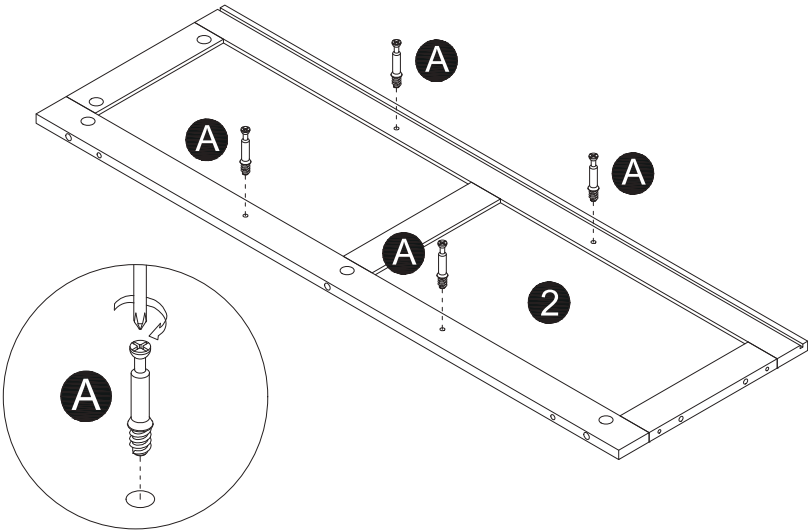
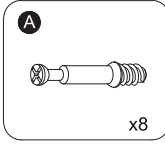
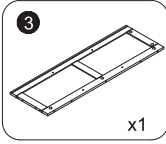
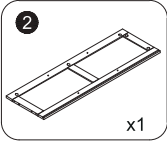

**Step 7** Install part **2** on part **5**, use part **B** to screw them.

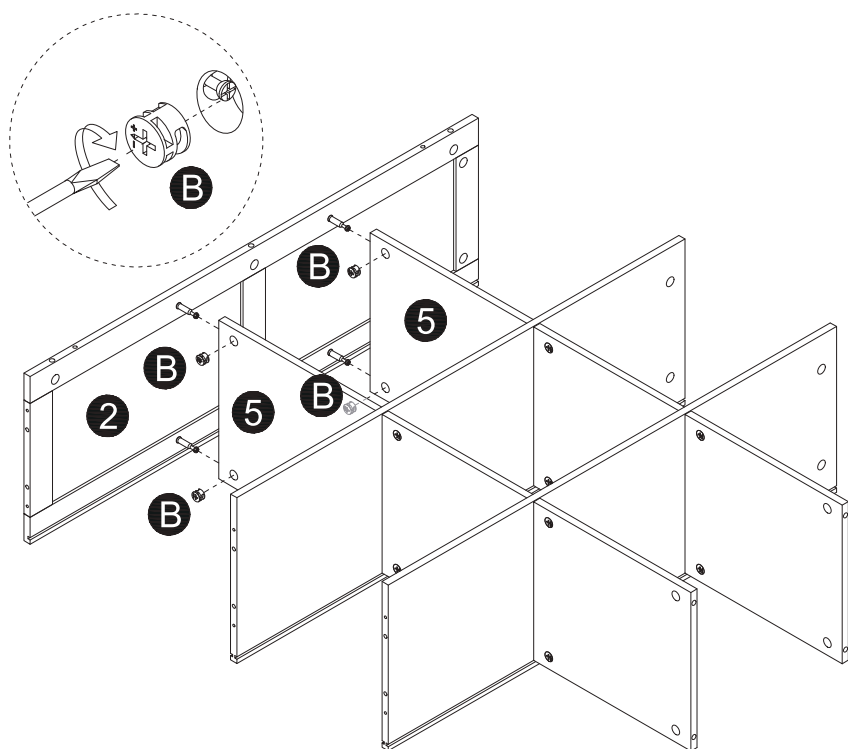
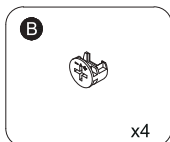

**Step 8** Install part **3** on part **6**, use part **B** to screw them.

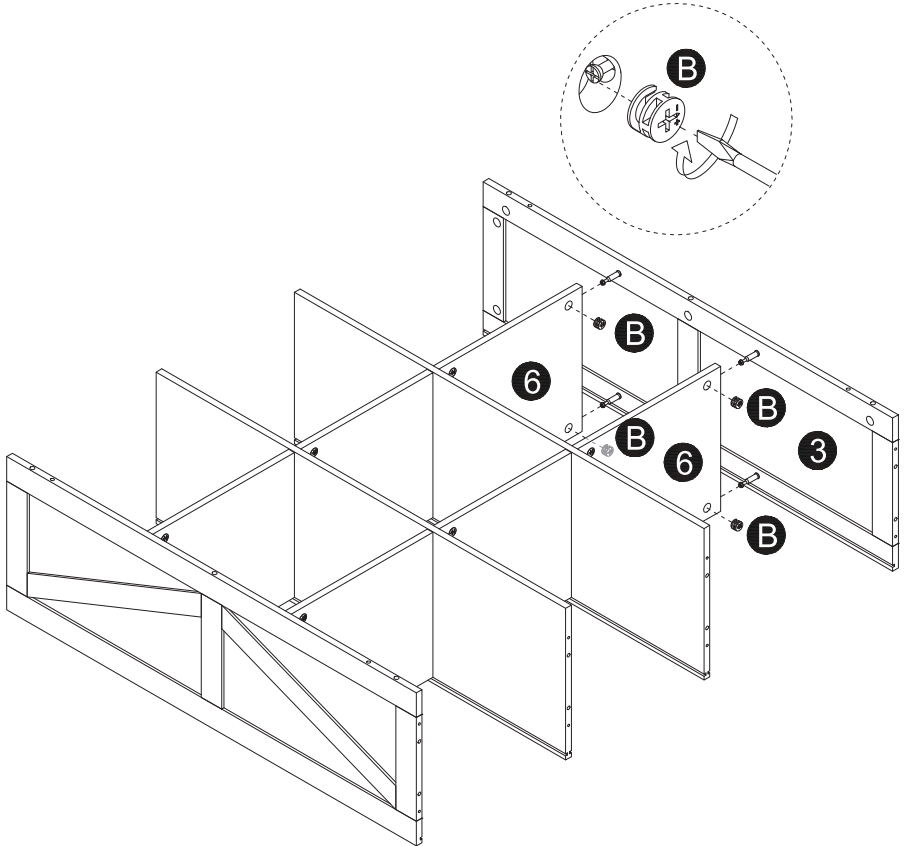
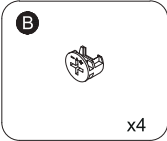

## Step 9

Insert part **D** into part **2** & **3** & **4**.

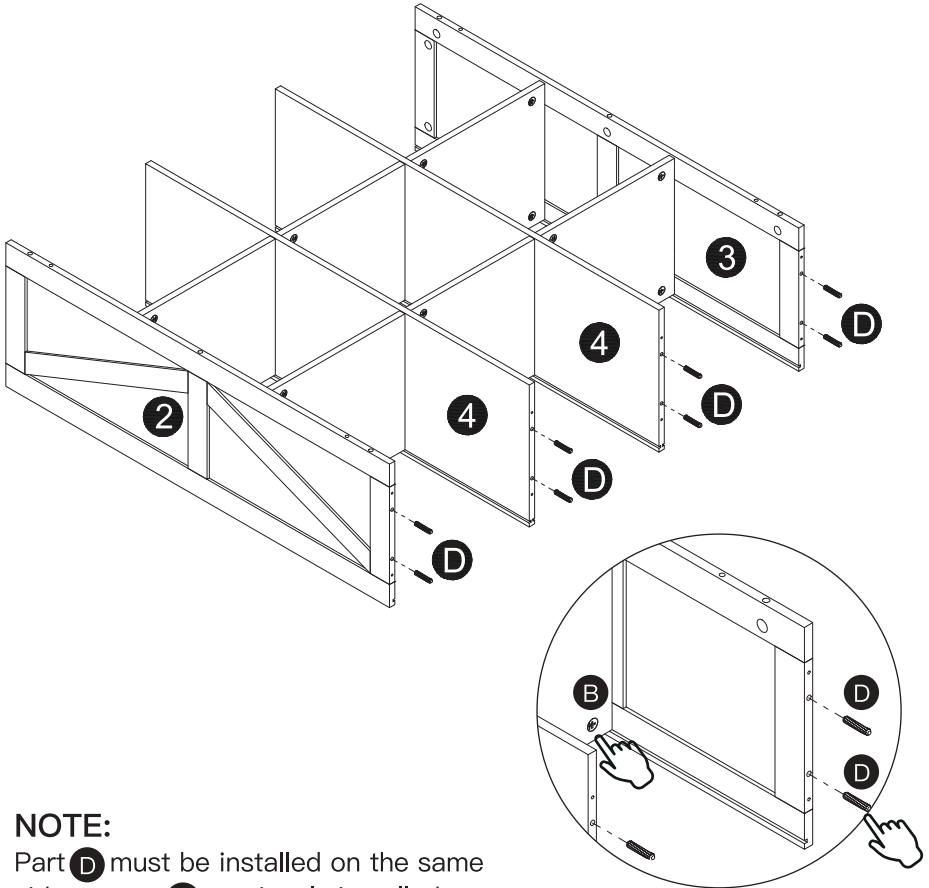
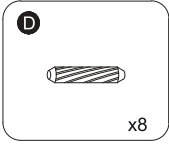

### NOTE:

Part **D** must be installed on the same side as part **B** previously installed.

## Step 10

Install part **7** on part **2** & **3** & **4**, use part **C** to screw them.

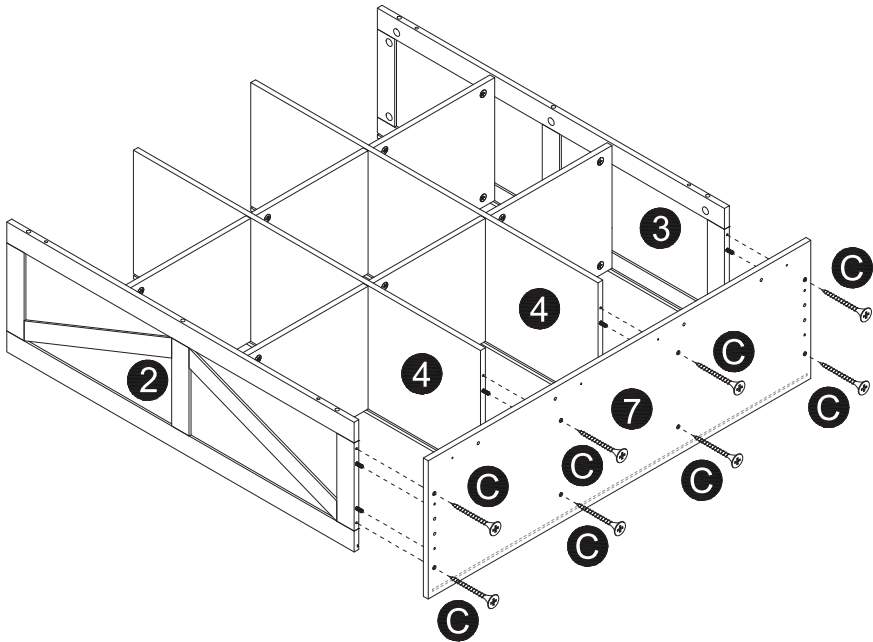
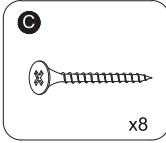
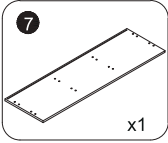

# Step 11

Insert part **D** into part **11** & **12**.

Install part **A** on part **11** & **12**. Install part **11** & **12** on part **13**, use part **B** to screw them. Cover them with part **E**.

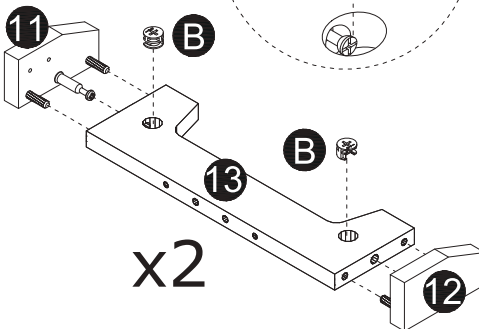
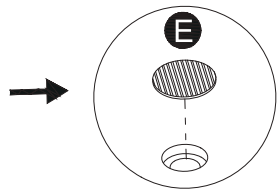
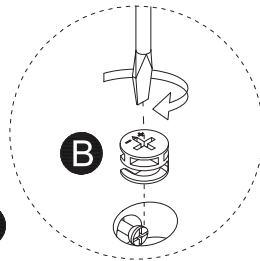
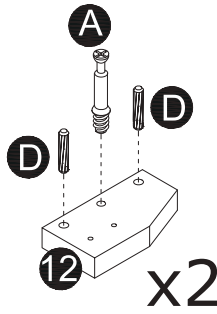
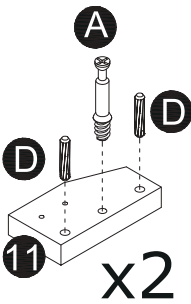
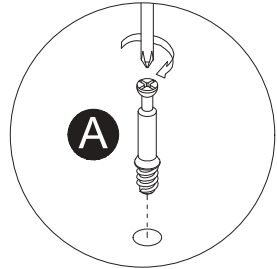
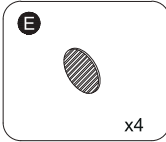
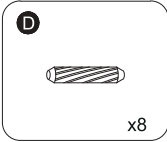
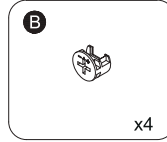
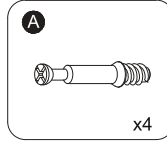
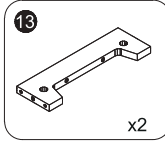
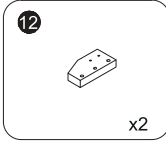
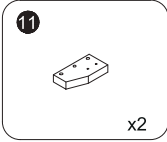

## Step 12

Connect part **13** with part **14**, use part **K** to screw them. Turn it over, Insert part **D** into part **13** & **14**.

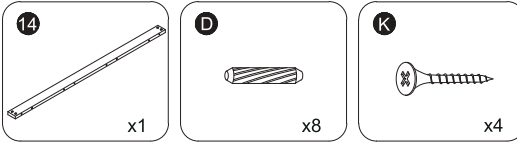

### NOTICE:

Make sure the side with 4 holes of part **14** is facing upwards.

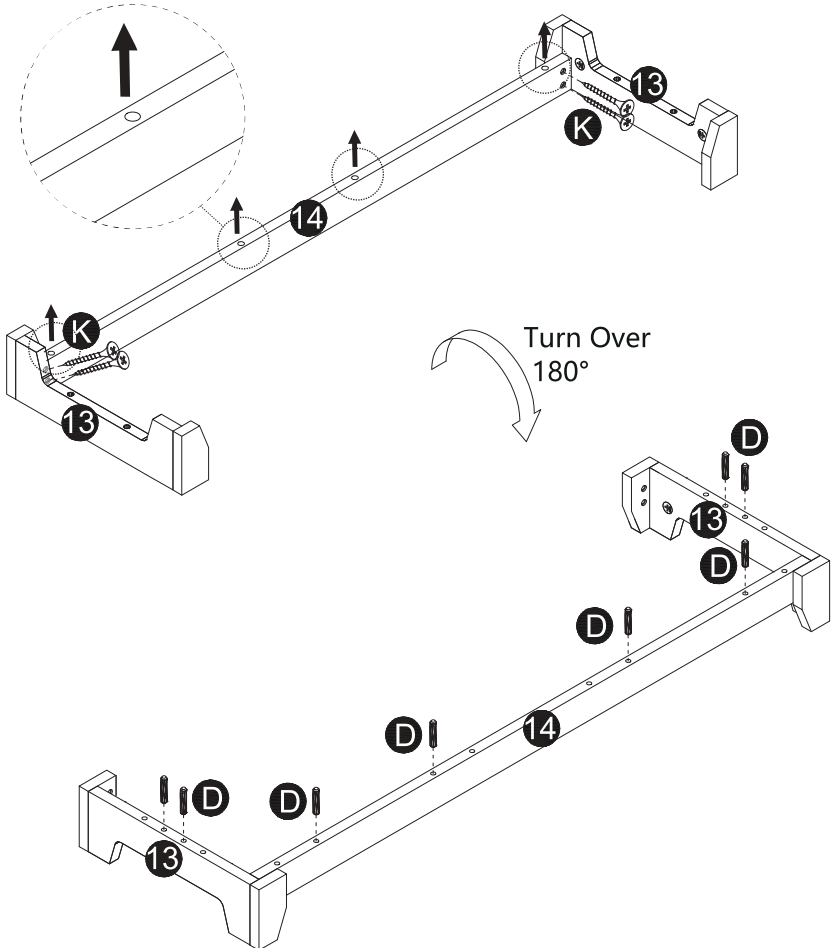

## Step 13

Install part 13 & 14 on part 7, use part 10 to screw them.

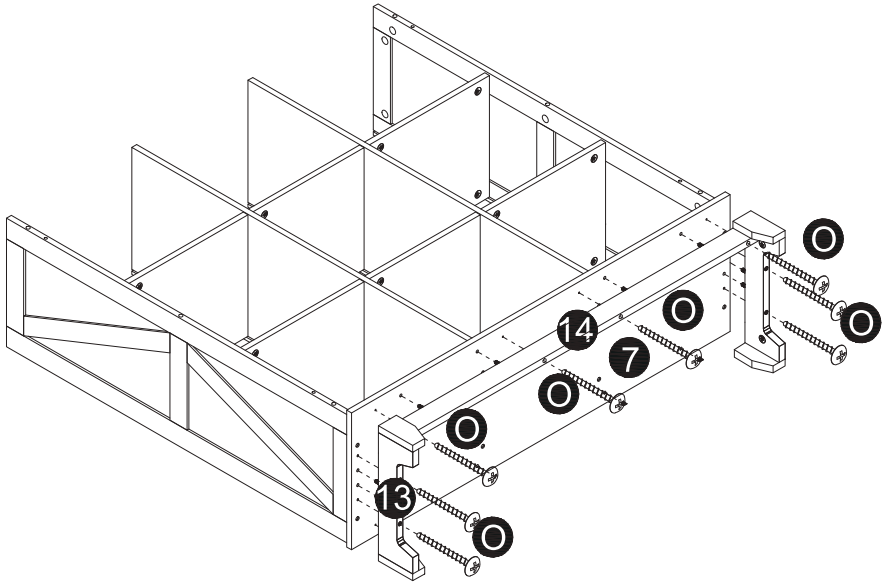
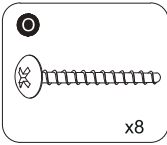

## Step 14

Install part **A** on part **10**. Install part **10** on part **2** & **3**, use part **B** to screw them. Cover them with part **E**.

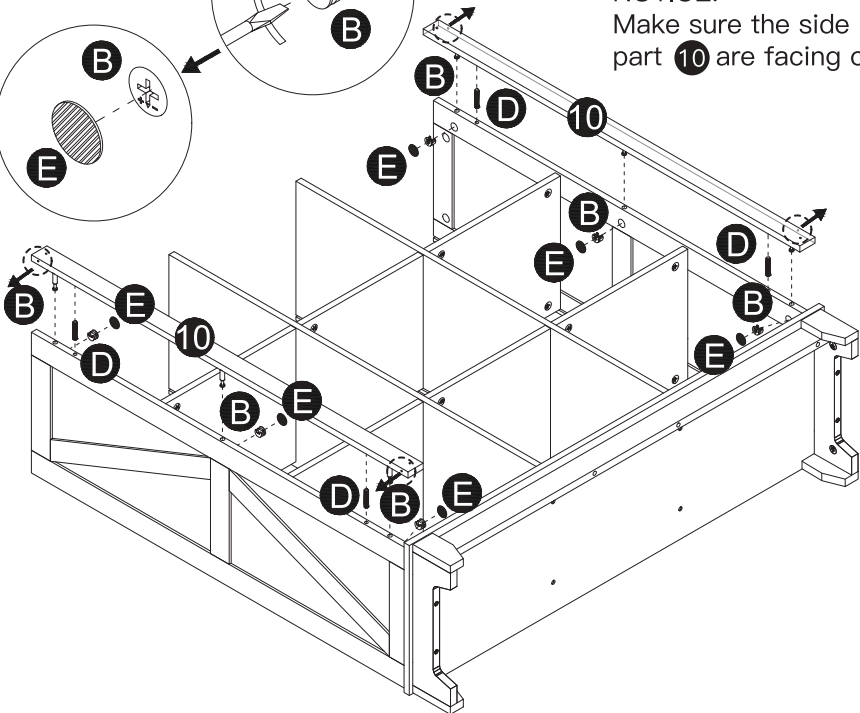
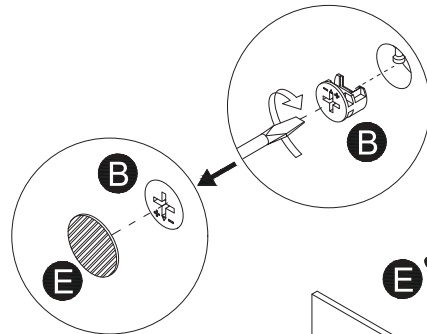
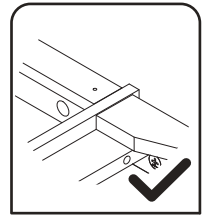
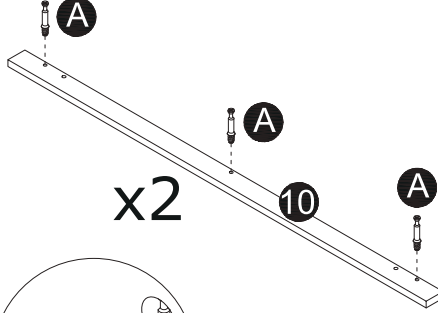
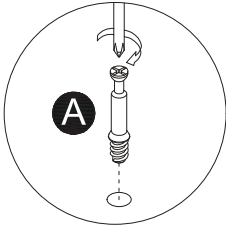
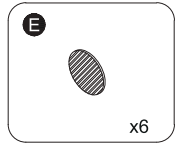
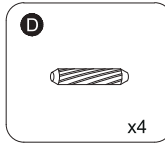
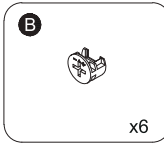
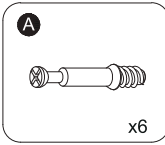
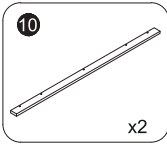

**NOTICE:**  
Make sure the side holes of part **10** are facing outwards.

## Step 15

Insert part 8 & 9 & 16 on the backside. Insert part D into part 2 & 3 & 4.

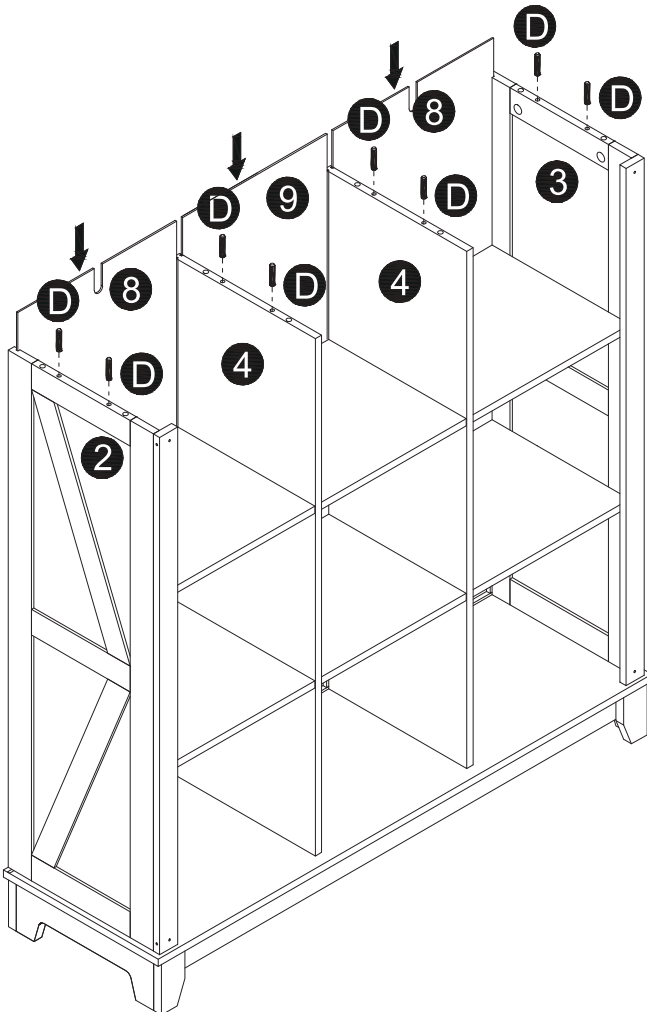
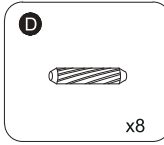
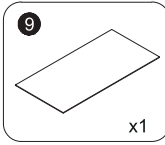
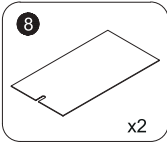

## Step 16

Install part **A** on part **1**. Install part **M** on part **1**, use part **G** to screw them.

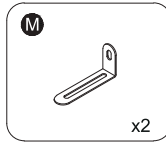
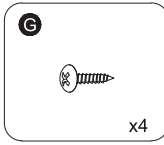
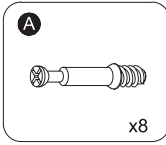
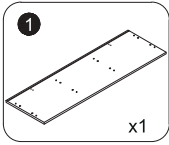

### NOTE:

Adjust the position of part **M** according to the distance between the wall and the dresser.

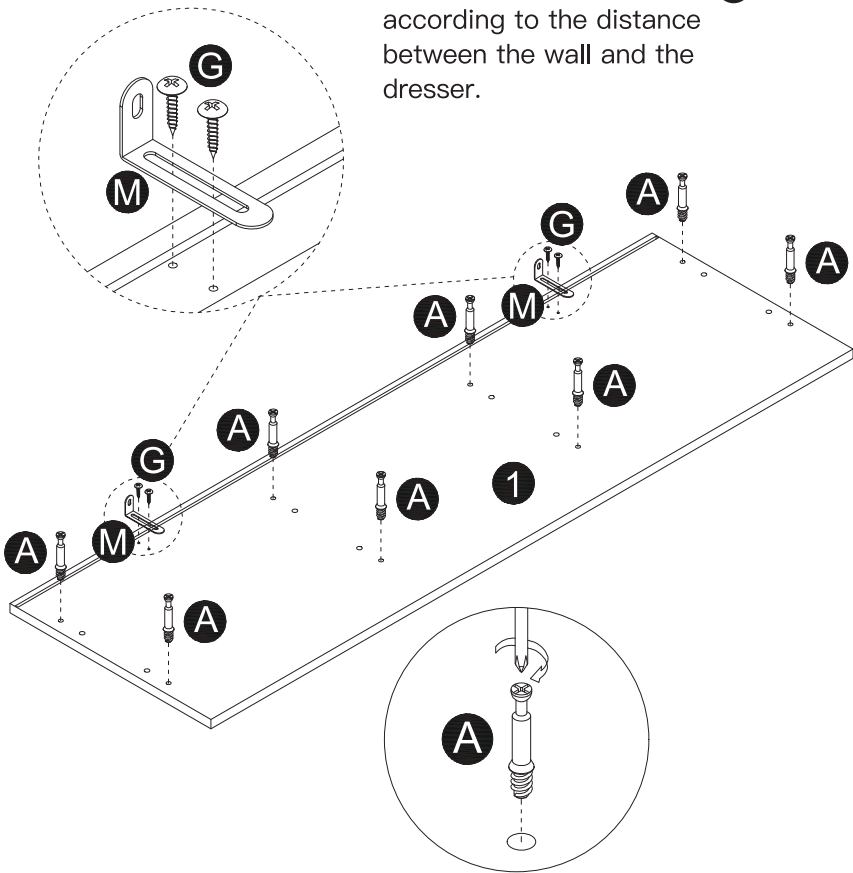

**Step 17** Install part 1 on part 2 & 3 & 4, use part B to screw them. Cover them with part E.

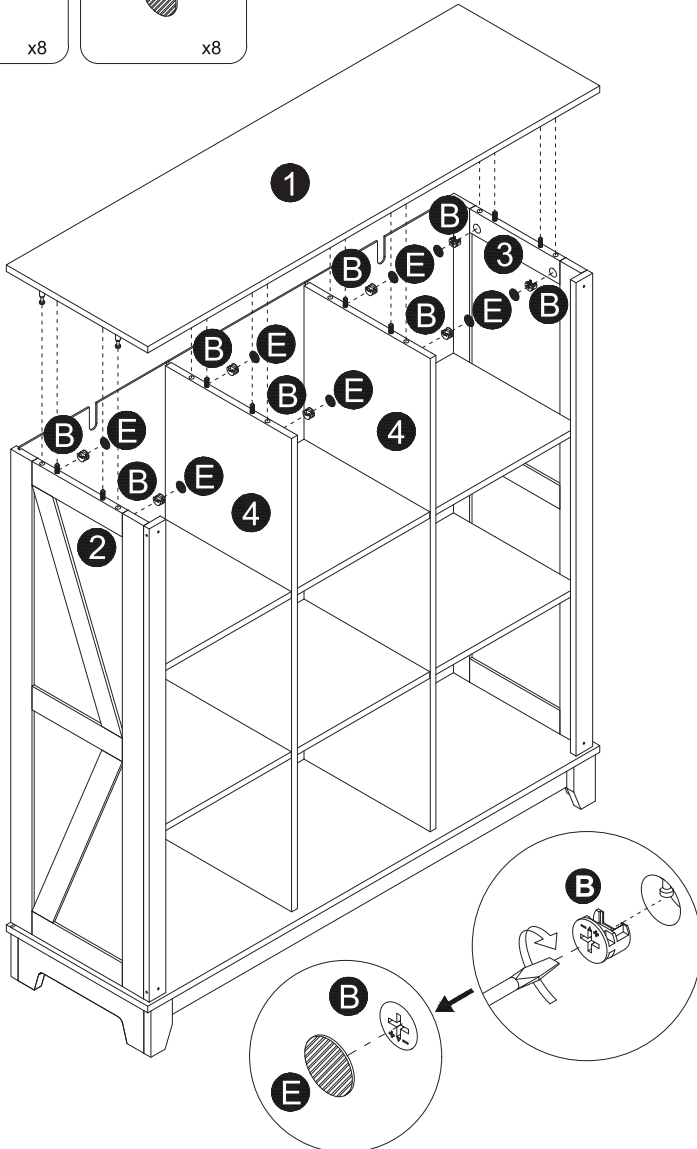
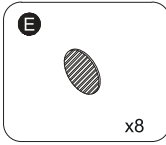
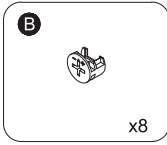

**Step 18** Install part **F** on part **10**, use part **G** to screw them.

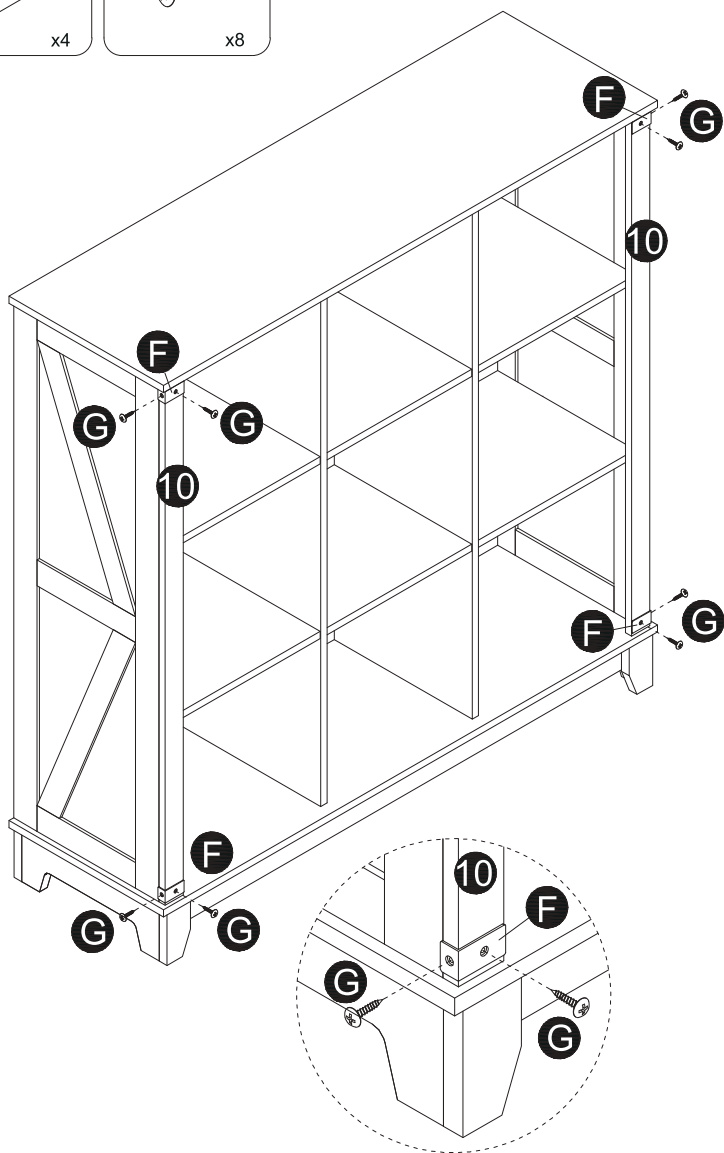
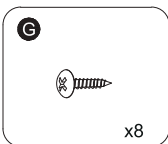
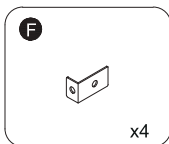

**Step 19** Insert part **J** along the grooves of backboard, screw them with part **I** for better stability.

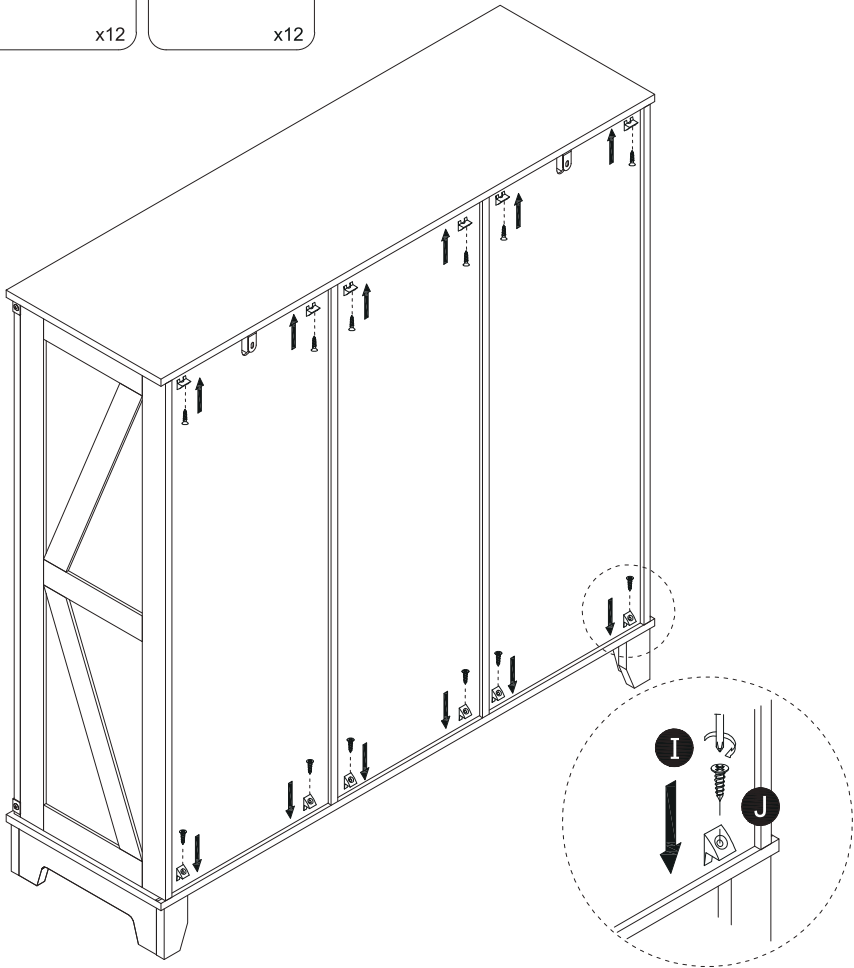
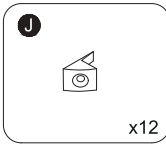
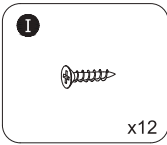

**BACK SIDE**

**Step 20** Drill 2 holes on a solid wall, then insert part **L**.

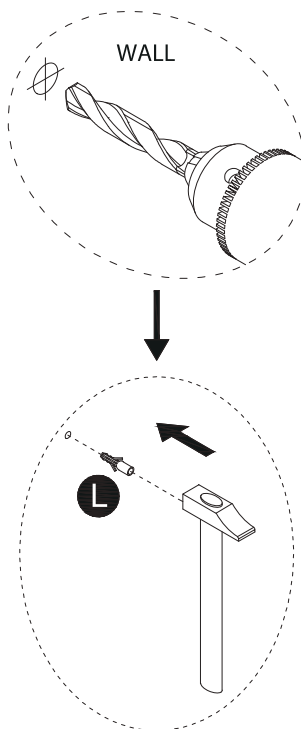
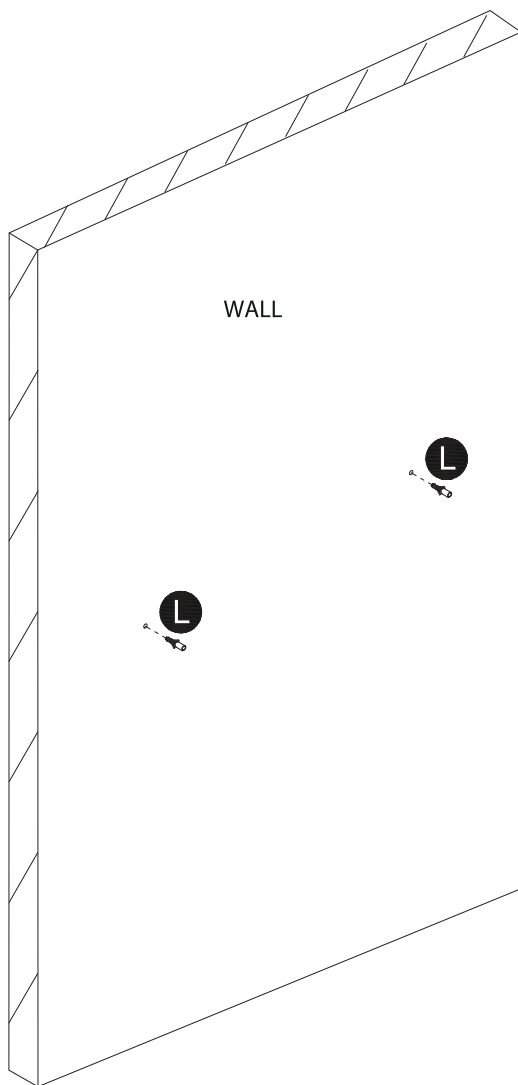
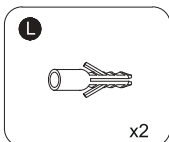

**Step 21** Fix the product on the wall with part **C**.

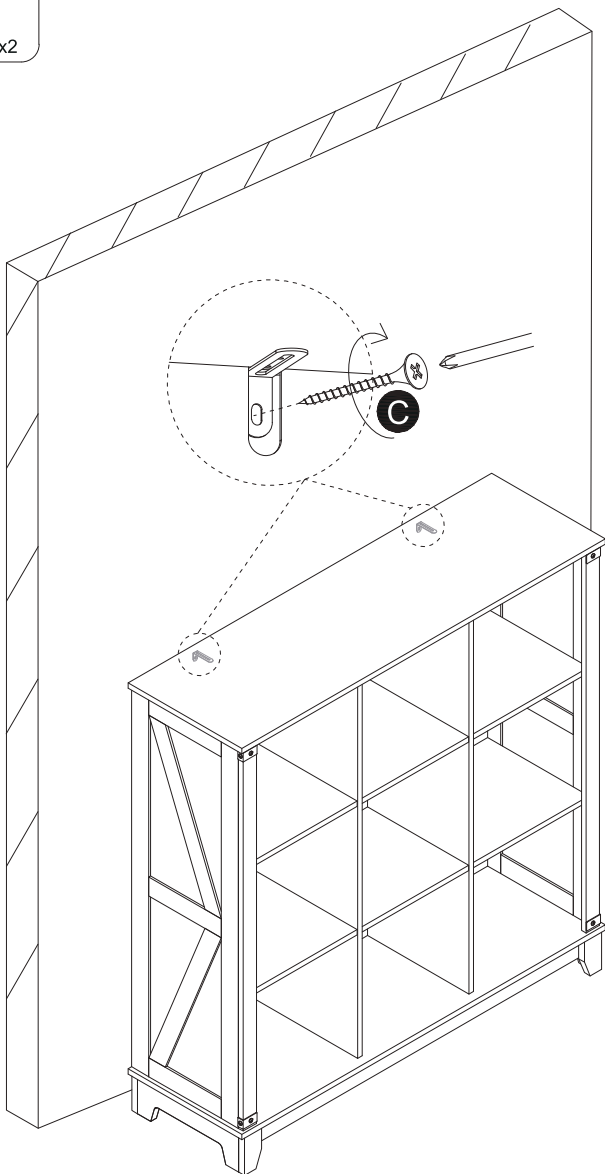
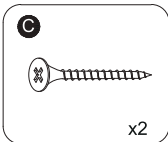

## After-sales Service

**Dear customer,**

We're excited that you've chosen our product to be a part of your home. We care deeply about your experience and want to make sure you have all the help you need.

If you have any questions while assembling your new product, don't hesitate to contact our dedicated customer support team through the original purchase platform.

Creating your ideal space is important, and we're committed to helping you every step of the way.

Thank you for choosing us, where comfort and style meet practicality.

Sincerely,  
Customer Service Manager