

Manual Book

Ceiling Fan with Lights

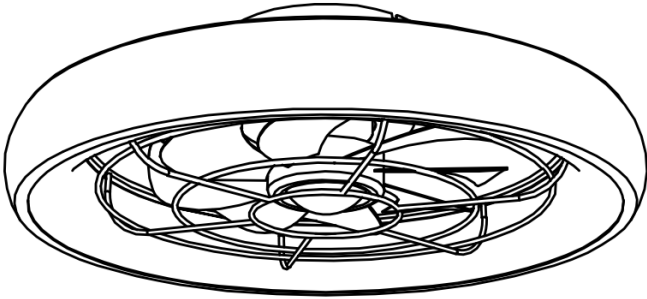

Scan for Installation Video



APP Control Applicable

Contact Information

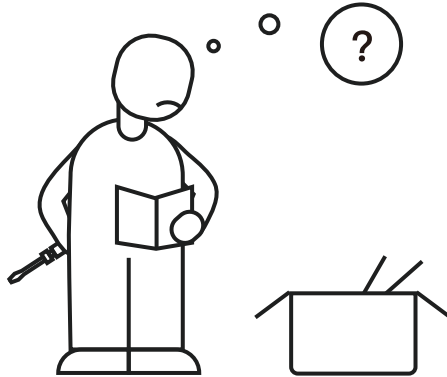

Please contact us with following information:

1. A screenshot of your order page, including the product picture, name, and order ID number.
2. Details of the problem, including pictures or a short video if possible.

Scan for Online Installation Video

Note: Product in the video may be different from this one.

Packing List



----- A

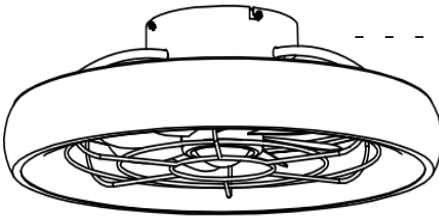

----- B

----- C

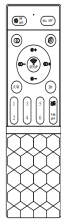

----- D

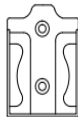

----- E

Part	Description	Quantity
A	Bracket	1
B	Canopy	1
C	Fan Assembly	1

Part	Description	Quantity
D	Remote Control	1
E	Remote Holder	1

Note: Some parts may be assembled together in the package.

Installation kit

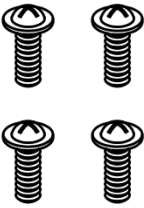

AA

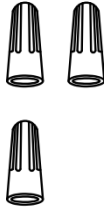

BB



CC

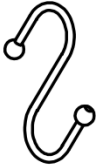

DD

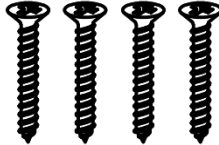

EE

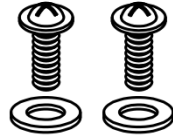

FF

Part	Description	Quantity
AA	Canopy Screw (assembled)	4
BB	Wire nut	3
CC	Pair of Gloves	1
DD	"S" Hook	1
EE	Wood Screw (optional)	4
FF	Machine Screw & Washer for Outlet Box (spares)	2

Note: For your convenience, you may receive extra hardware.

Safety Rules

1. Be sure the power to the wires you are working on is disconnected, either the fuse is removed or the circuit breaker is turned off. Turning the power off using the light switch is not sufficient to prevent electrical shock.
2. A qualified licensed electrician is required for the installation.
3. The outlet box and support structure must be securely mounted and capable of reliably /supporting a minimum of 50 pounds. Use only UL (cUL for Canadian Installation) listed mounting boxes marked "FOR FAN SUPPORT".
4. The fan must be mounted with a minimum of 7 feet clearance from the trailing edge of the blades to the floor.
5. Do not operate reversing switch while fan blades are in motion (if applicable). Fan must be turned off and blades stopped before reversing blade direction.
6. Do not place any objects in the path of the blades.
7. To avoid personal injury or damage to the fan and other items, be cautious when working around or cleaning the fan.
8. Do not use water or detergents when cleaning the fan or fan blades. A dry dust cloth or lightly dampened soft cloth will be suitable for the cleaning.
9. After marking electrical connections, spliced conductors should be turned upward and pushed carefully up into outlet box. The wires should be spread apart with the grounded conductor on one side of the outlet box.
10. Electrical diagrams are reference only, different fan light may have different light shade and bulbs.
11. Use only our replacement parts. This equipment has been tested and found to comply with the limits for a class B digital device, pursuant to part 15 of the FCC Rules. These limits are to provide reasonable protection against harmful interference in a residential installation. This equipment generates, uses and can radiate radio frequency energy and if not installed and used in accordance with the instructions may cause harmful interference to radio communications.

Warning:

To reduce the risk of personal injury, use only the two steel screws and washers provided with the outlet box for mounting to the outlet box. Most outlet boxes commonly used for the support of lighting fixtures are not acceptable for fan support and need to be replaced, consult a qualified electrician if in doubt.

To reduce the risk of fire, electric shock or person injury, mount fan to outlet box marked "acceptable for fan support".

To reduce the risk of personal injury, do not bend the blade brackets (also referred to as flanges) during assembly or after installation. Do not insert objects in the path of the blades.

Installation Preparation

Tools You Need

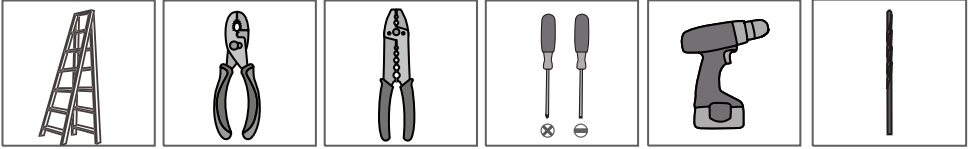

Ladder

Pliers

Wire Strippers

Screwdrivers

Power Drill (optional)

Drill Bit (optional)

If mounting to a support structure, you will also need the optional tools.

What to Expect with Your Installation

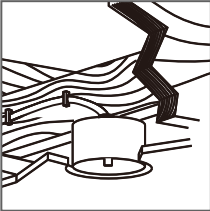

Must be able to secure the fan to building structure or fan-rated outlet box

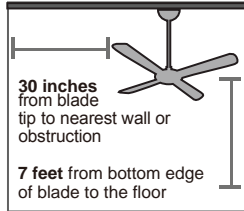

Assess location



Check box to see fan weight



Angled Ceiling not supported

Installation Step 1 (Mount the Bracket)

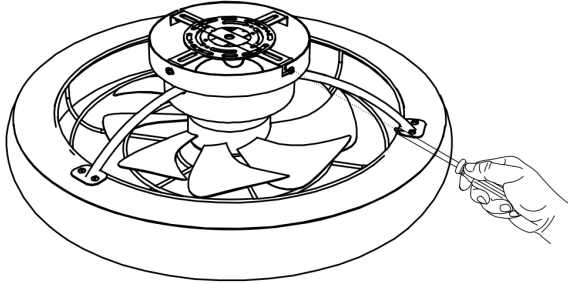

Loosen the screws on the canopy (remove the screws corresponding to the two round holes and keep the screws corresponding to the two "L" holes), and then remove the bracket from the canopy.

With outlet box: Use the screws on the outlet box to secure the bracket to the outlet box.

Without outlet box: Use 4 wood screws to fasten the bracket crossbar to the solid wood structure

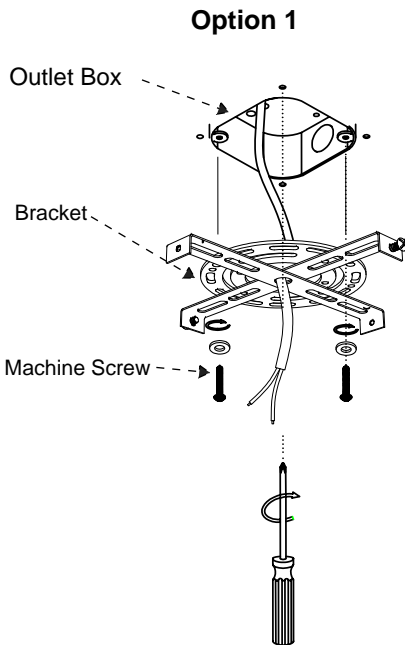

OR

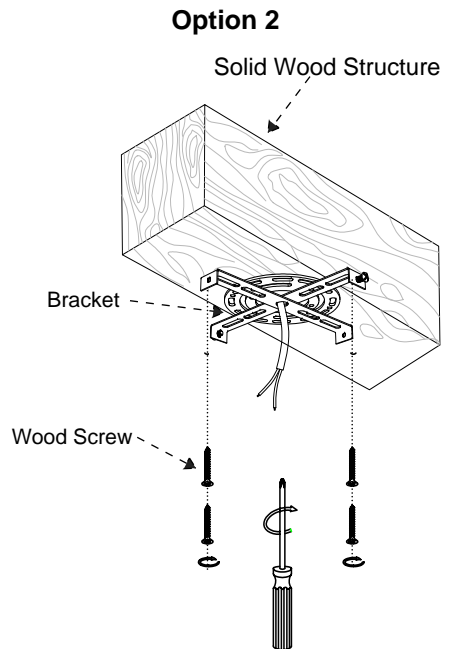

Installation Step 2 (Connect the Wires)

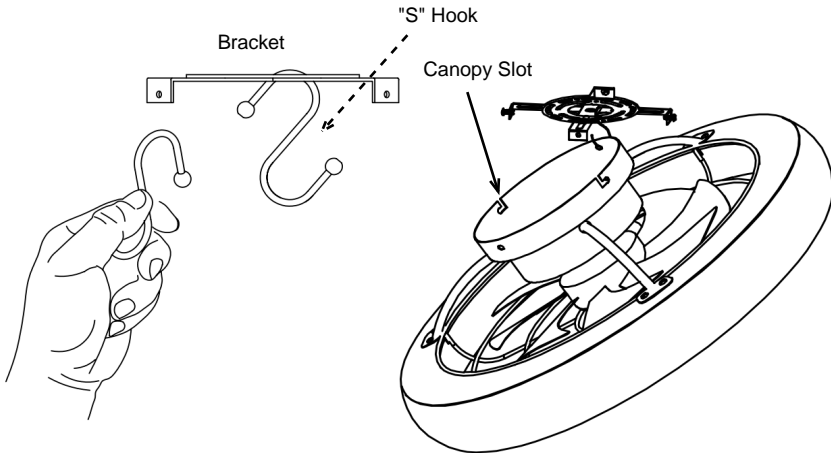

1. Hang the fixture onto the bracket with "S" hook provided.

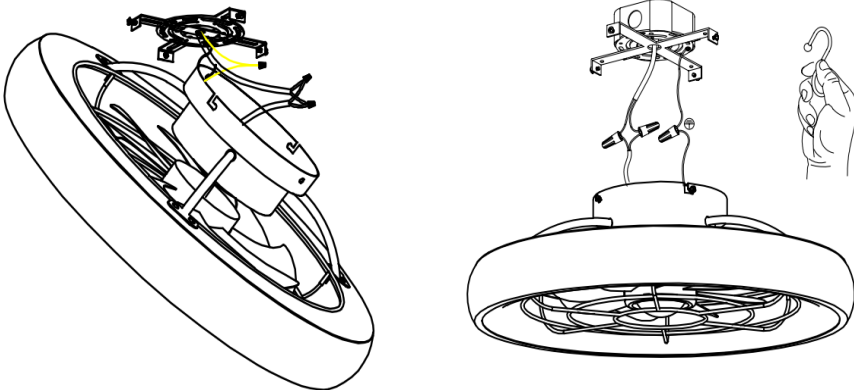

2. Connect the wires from the fixture to the wires from the outlet box using wire nuts: ground wire (green, green/yellow, or bare copper) to ground wire, neutral wire (white) to neutral wire, and hot wire (black) to hot wire. Then, wrap each connection with electrical tape.

3. Remove the "S" hook (hold the fan with your hand when disassembling).

Installation Step 3 (Fix the Canopy)

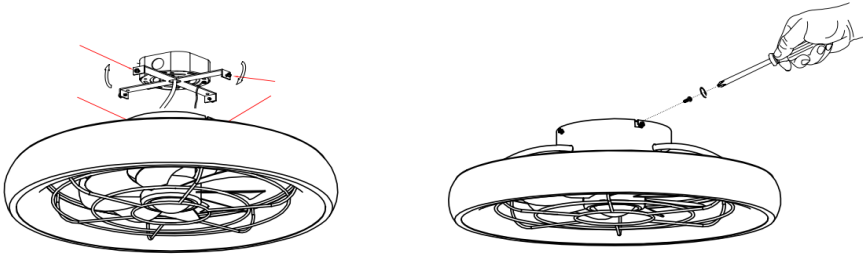

1. Align the "L" groove on the canopy with the bracket's screw, and rotate the canopy to lock it onto the bracket.
2. Reinsert the two bracket screws, removed in the previous step, through the "R" groove and secure them back onto the bracket.
3. Tighten the screws.

Installation Step 4 (Install the Remote Holder)

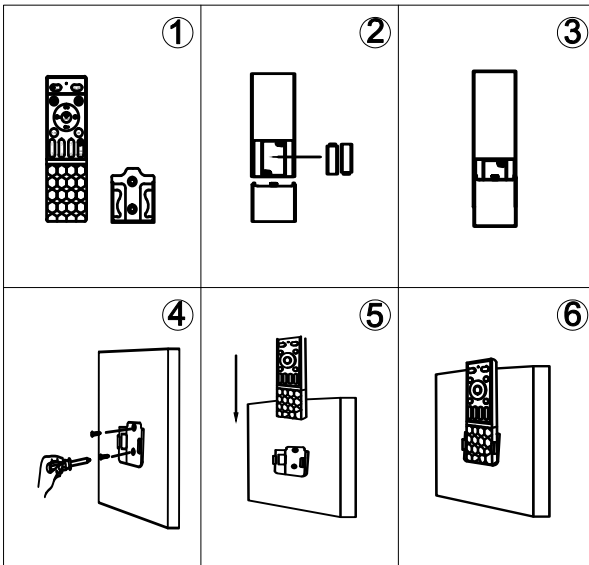

1. Insert 2 batteries before using:
AAA 1.5V battery x 2pcs
(not included)
2. Install the remote holder onto the wall with screws.

Remote Control Instructions

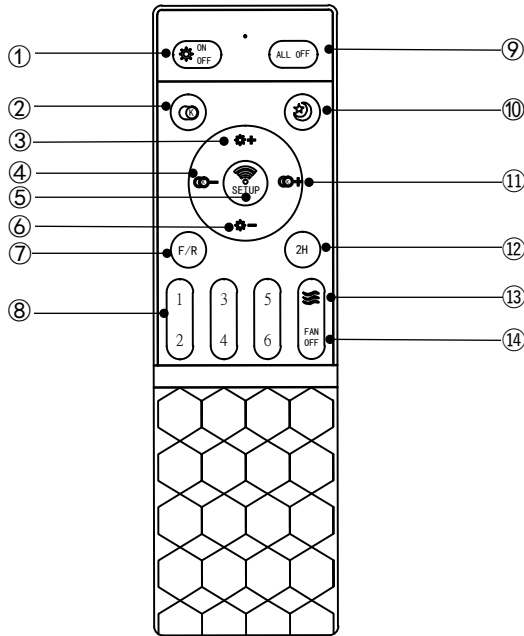

NOTE:

**Please insert 2 batteries before using.
AAA 1.5V battery x 2pcs (not included)**

- ① **Light On/Off:** Press to turn the light on or off.
- ② **Quick Light Color Switch:** Press to quickly switch between light colors.
- ③⑥ **Light Brightness +/-:** Press to +/- the brightness of the light.
- ④⑪ **Light Color Temperature +/-:** Press to +/- the light color temperature.
- ⑦ **Fan Forward/Reverse:** Press to change the direction of the fan blades.
- ⑧ **Fan Speeds:** Press to adjust the fan speed from 1 to 6.
- ⑨ **All Off:** Press to turn off the fan and light.
- ⑩ **Night Mode:** Press to dim the lights.
- ⑫ **Fan Timer:** Press to set the timer for the fan to turn off.
- ⑬ **Wind Direction:** Press to turn on/off the wind guide wheel to change the wind direction.
- ⑭ **Fan Off:** Press to turn off the fan.

















Signal Pairing: If the remote control loses signal from the fan, press and hold the Signal Pairing button ⑤ at the beginning after turning on the wall switch until the light flashes. This will pair the remote control to the fan.

APP Control Instructions



Install the "FanLamp Pro" app from Google Play, Apple App Store, or other app stores by scanning the QR code or searching for the app name. Ensure that your phone is connected to the internet and Bluetooth enabled.



-  Pairing: Click the Pair button within 5 seconds after turning on the fan from the wall switch. Once the fan flashes or beeps, it has been successfully paired with your phone and can now be controlled through the app.
-  Slide the slider to change the fan speed.
-  Slide the slider to change the brightness of the light.
-  Quick switch for "White" light color.
-  Quick switch for "Yellow" light color.
-  Quick switch for "Natural" light color.
-  Night mode: Dim the lights.
-  Fan moves forward.
-  Change the direction of the wind (Not applicable on this fan).
-  Timing the fan.
-  Natural wind: The fan speed will change automatically when you use this function.
-  Sleeping wind (Not applicable on this fan).
-  Fan moves reversely.
-  Turn on/off the light.
-  Turn on/off the fan.
-  Unpairing: Click the Unpair button within 5 seconds after turning on the fan. Once the fan flashes or beeps, it has been successfully unpaired from your phone.

Trouble Shooting

1. Fan does not work

- Make sure the fixture is connected to an ON/OFF wall switch, not a dimmer switch.
- Check the remote control battery (not included in this package).
- Check the circuit breaker to ensure the power is on.
- Turn off power from the circuit breaker, then loosen the canopy and check all the connections according to the wiring diagram.

2. Lights do not light up / flicker / noisy operation

- Make sure the fixture is connected to an ON/OFF wall switch, not a dimmer switch.
- Check your power and switch to make sure it's powered on.

3. Noisy operation

- Re-tighten all screws on the bracket.
- Check to see if any of the blades are cracked. If so, replace the blades.

4. Remote does not work

- Make sure the battery is installed correctly.
- Pair the remote control again (See page 9).
- Install two new batteries.

Clean And Care

To clean, wipe the fixture with soft cloth. Spray from chemical cleaners can discolor the finish of the fixture. Do not use scouring pads, powders, steel wool or abrasive paper to clean this fixture.

Ordering Parts

Keep this manual for future reference, and in case replacement parts are needed. Available parts can be ordered from place of purchase. Use exact wording from diagrams when ordering parts.