

Name: Urban PF/60

Design: Joana Bover / 2011

Typology: Ceiling lamp



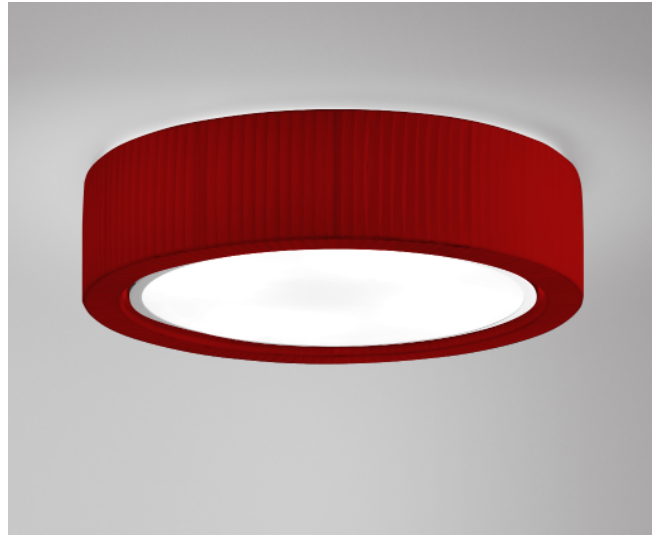

Environment: Indoor

Technical description:

Ceiling lamp with frame, coated in brilliant chrome and hand wrapped with translucent, polyester blend ribbon in cream, white or red. Glass, opaque diffuser is included with fixture. Available in smaller and larger format.



Lamps description



-  Grounding: compulsory
-  4 x 60 W E26 A15 INC
-  4 x 5 W E26 A15 LED
-  4 x 14 W E26 Triple CFL

Voltage: 120V~60Hz

 1 Box 25.59 x 25.59 x 9.84 inches

Vol.: 3.7292 ft³

Weight: 17.64 lbs

Certifications:  

 Photometrics made according to the position the lights are shown in the catalogue and price list.

Ref	Finishings
0232506BU	Chrome White Translucent Ribbon
0232506CU	Chrome Cream Translucent Ribbon
0232506RU	Chrome Red Translucent Ribbon
Customizable	

Measures

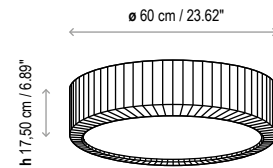

Urban PF/37

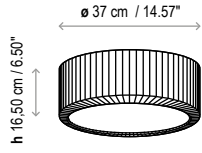

Urban PF/60

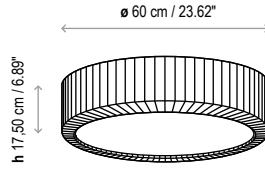

Urban PF/90

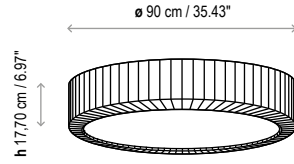

Urban PF/120

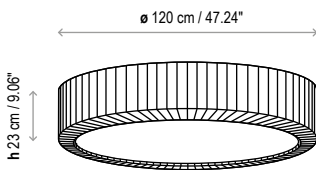

Urban S/37

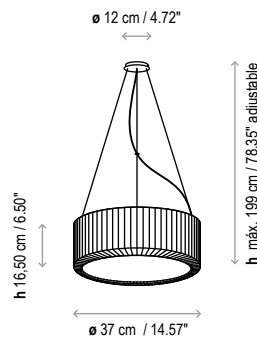

Urban S/60

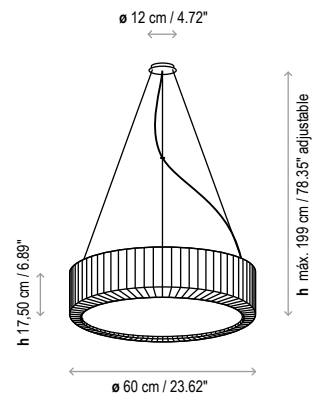

Urban S/90

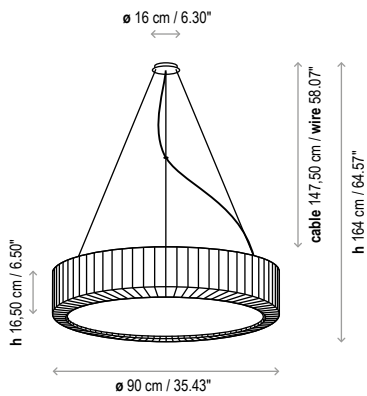

Urban S/120

