

## ⚠ WARNING

- **INGESTION HAZARD:** This product contains a button cell or coin battery.
- **DEATH** or serious injury can occur if ingested.
- A swallowed button cell or coin battery can cause **internal Chemical Burns** in as little as **2 hours**.
- **KEEP** new and used batteries **OUT OF REACH** of **CHILDREN**
- **Seek immediate medical attention** if a battery is suspected to be swallowed or inserted inside any part of the body.



- Remove and immediately recycle or dispose of used batteries according to local regulations and keep away from children. Do NOT dispose of batteries in household trash or incinerate.
- Even used batteries may cause severe injury or death.
- Call a local poison control center for treatment information.
- Cell Battery type: CR2025 ; Nominal battery voltage: 3 V
- Non-rechargeable batteries are not to be recharged
- Do not force discharge, recharge disassemble, heat above 60°C or incinerate. Doing so may result in injury due to venting, leakage or explosion resulting in chemical burns.
- Ensure the batteries are installed correctly according to polarity (+ and -).
- Remove and immediately recycle or dispose of batteries from equipment not used for an extended period of time according to local regulations.
- Always completely secure the battery compartment. If the battery compartment does not close securely, stop using the product, remove the batteries, and keep them away from children.

MADE IN CHINA

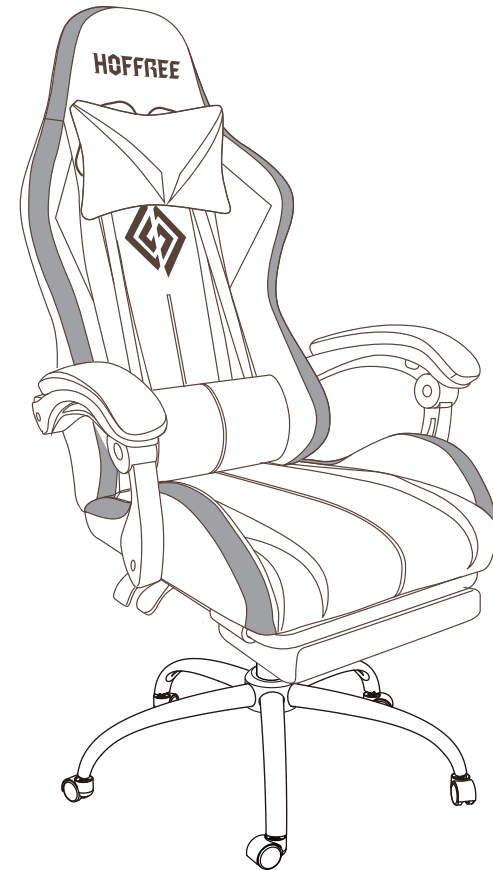









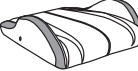
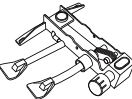
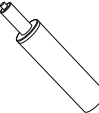



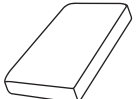
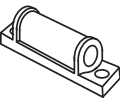
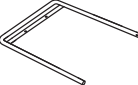



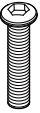

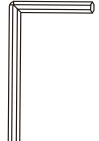

## Gaming Chair

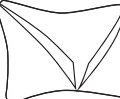
User Manual

HOGC-GP103

## PACKING LIST

<b>A*1</b> 	<b>B*1</b> 	<b>D*1</b> 	<b>E*1</b> 	<b>F1*1</b>  <b>F2*5</b> 
<b>G*5</b> 	<b>R*1</b> 	<b>Y*2</b> 	<b>T*1</b> 	<b>C-R*1</b> 
<b>C-L*1</b> 	<b>H*4</b>  6*20mm	<b>P*3</b>  6*40mm	<b>J*4</b>  8*40mm	<b>X*4</b>  6*25mm
<b>S*2</b>  6*30mm	<b>W*1</b>  5x10mm	<b>L*1</b> 	<b>K*1</b> 	<b>M*1</b> 
<b>N*1</b> 	<b>Q*4</b> 	<b>Z*1</b> 	<b>V*1</b> 	<b>I*10</b>  6x14mm

## INSTALLATION

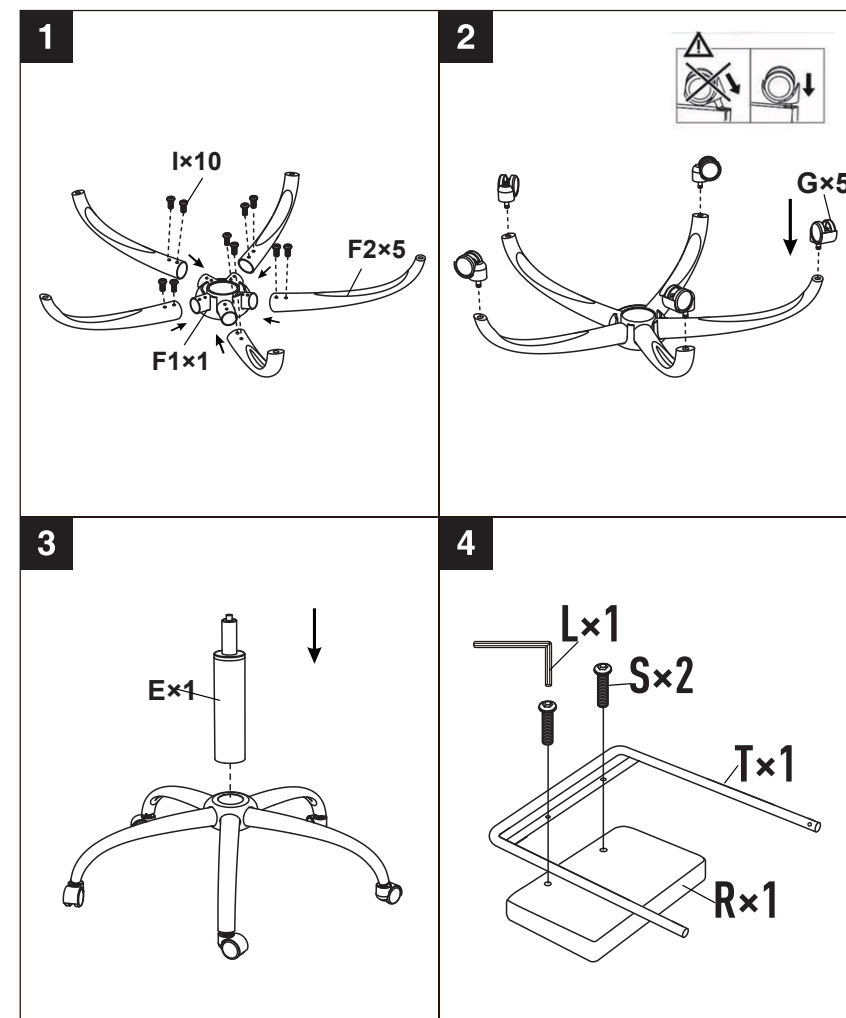

## BLUETOOTH CONNECTION (bluetooth name HuaBox)

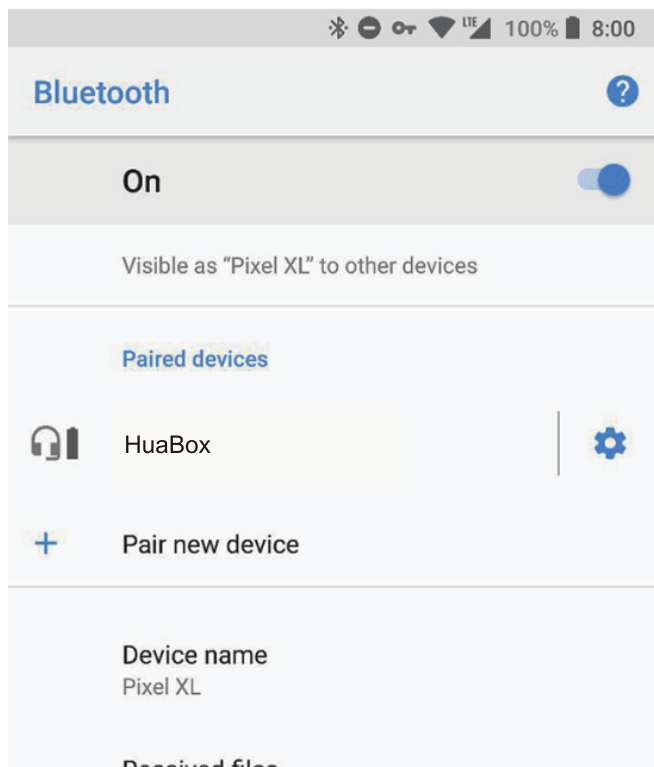

## FUNCTIONS OF EACH BUTTON

	<b>ON&amp;OFF</b>	
	<b>Speed adjustment</b>	
	<b>358 flicker patterns to change</b>	
	<b>Brightness adjustment</b>	
	<b>LOCK</b> <b>Match:</b> Press and hold "LOCK" for 5 seconds until green strip flash 3 times. <b>Cancel the match:</b> Press and hold "LOCK" for 5 seconds until white strip flash 3 times.	
	<b>Auto mode</b> Press to play automatically 358 modes. Press 5 times to enter color RGB mode <b>Single cycle play</b> Under AUTO mode, press "SETTING" once, then press "LOCK" once to cyclic the current pattern.	
	<b>SETTING</b> Adjust the LED quantity: Press and hold for 5 seconds until white strip flash to enter the setup menu. Press MODE +/- to adjust the quantity of the LED light. Press "SETTING" to finish the setting.	
	<b>Static Monochrome Mode</b> White, Red, Green, Purple, Yellow, Blue, Pink	
Long press the setting key to enter the setting mode <b>MODE+/-</b> - adjust the lighting part (left/right side of backrest/entire seat cushion) <b>SPEED+/-</b> - to adjust the number of lamp beads (cannot be adjusted when the light strips are fully on, only when part of the light strips are on, the number of lamp beads can be increased or decreased)		

## USAGES

<p><b>Testing</b></p>	<p>Continuously press "AUTO" 5 times to enter the RGB automatic switching mode, which can test the your LED.</p>
<p><b>Matching</b></p>	<p>Press "LOCK" for 5 seconds until LED flash in green quickly to match the remote control with the receiving controller. Press "LOCK" for 5 seconds until LED flash in white slowly to un-match.</p>
<p><b>Reorder RGB</b></p>	<p>Different kinds of LED, the RGB keys may not perfectly match to your LED, reorder them if needed. Continuously press "SETTING" 5 times until LED flash in white once and then turn into all white, press the "R" until LED is red, press "G" until LED is green, press "B" until LED is blue, finally press "SETTING" once to finish your setting.</p>
<p><b>Adjust the LED quantity</b></p>	<p>Press "SETTING" for 5 seconds until LED flash in white to enter the setup menu. Press "MODE +/-" or "SPPED +/-" to add/reduce the quantity of the LED pixels. Finally press "SETTING" once to finish the setting.</p>

## TROUBLESHOOTING

Fault conditions	Possible causes	Exclusion method
<p>The product is shaking and unstable</p>	<ol style="list-style-type: none"> <li>1. Wrong screw installation</li> <li>2. The screw is broken</li> <li>3. Check that the screws are not tightened in place</li> </ol>	<ol style="list-style-type: none"> <li>1. According to the instruction manual, install the correct screw in the correct position</li> <li>2. To replace, use the included spare screws</li> <li>3. Tighten the loose screws</li> </ol>
<p>The light strip is off</p>	<ol style="list-style-type: none"> <li>1. Not plugged in</li> <li>2. The lighting pattern is not saved correctly</li> </ol>	<ol style="list-style-type: none"> <li>1. Confirm that the product is powered on normally</li> <li>2. Please read the instructions of the remote control carefully (page 6), and follow the operation</li> </ol>
<p>Audio doesn't work</p>	<ol style="list-style-type: none"> <li>1. Bluetooth connection failed</li> <li>2. Bluetooth connection error</li> </ol>	<ol style="list-style-type: none"> <li>1. Turn on your phone's bluetooth to connect</li> <li>2. Turn off the phone's Bluetooth and reconnect (Bluetooth name: HuaBox)</li> </ol>
<p>Remote control not working</p>	<ol style="list-style-type: none"> <li>1. The remote control gasket is not pulled out and cannot work</li> <li>2. The battery is in poor contact or the battery is installed backwards</li> <li>3. The battery is dead</li> </ol>	<ol style="list-style-type: none"> <li>1. Check whether the remote control gasket is pulled out</li> <li>2. Check whether the battery is installed incorrectly and adjust</li> <li>3. Replace the new battery to make the remote control work normally</li> </ol>

# INSTALLATION

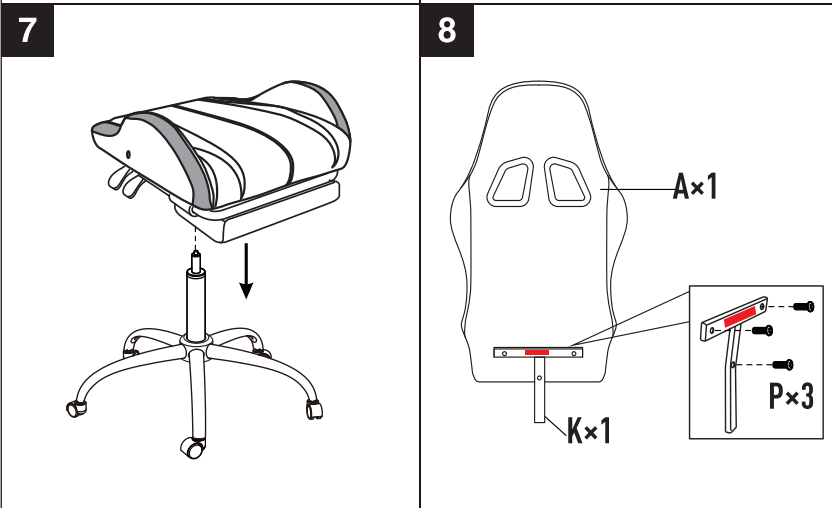
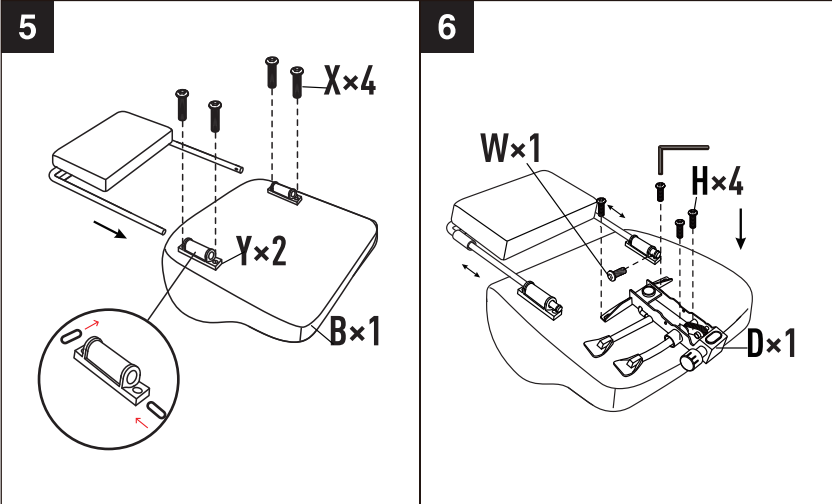

# INSTALLATION

