

Instruction Manual

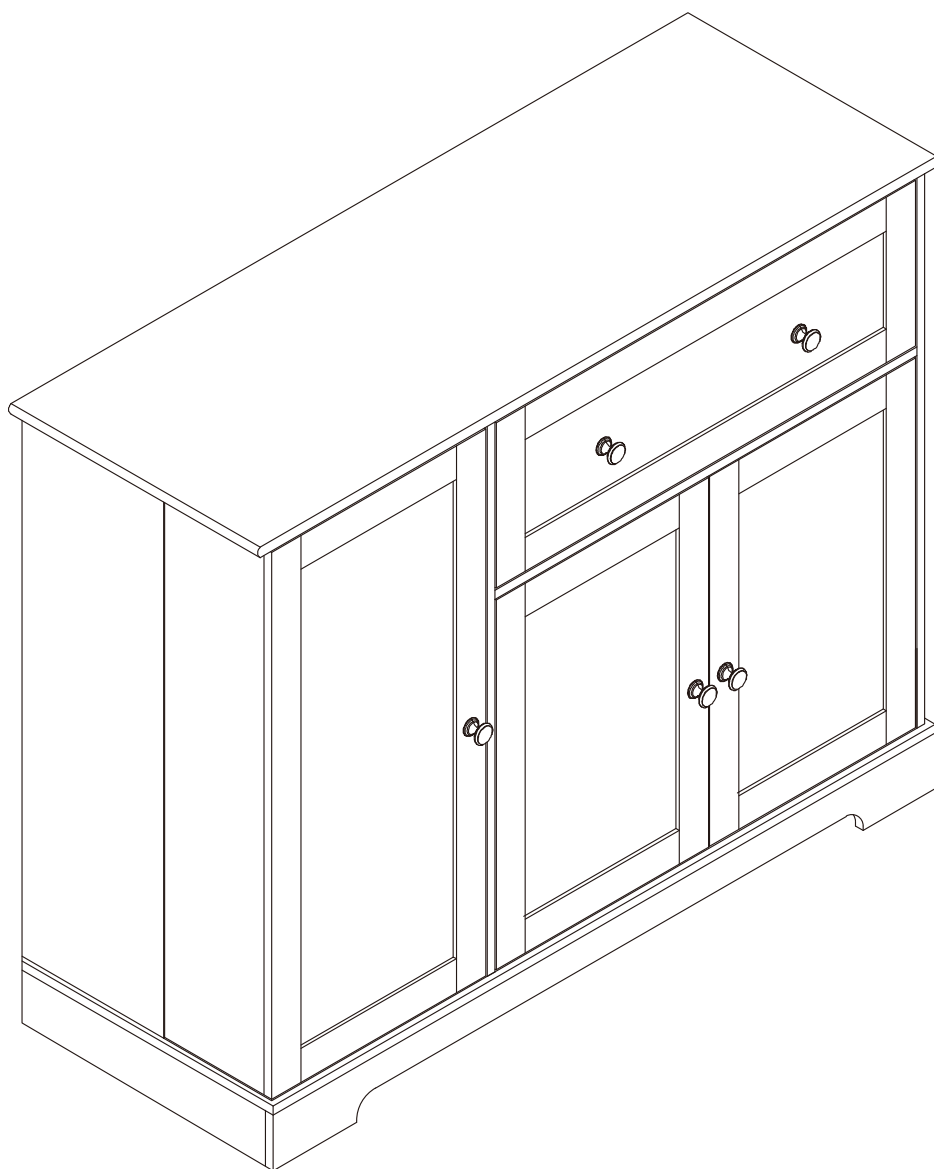

Pantry Cabinet

EN

Thank you for purchase on our products. Please contact us if you have difficulty with assembly or need replacement parts. Our customer service is here to assist you. Please attach your User Name or Order ID so that we can assist you better.

WARNING

Serious or fatal injury may occur from unexpected assembly or use.

1. During the assembly process, keep all parts away from babies or children.
2. Always securely fix this product to the wall. Make sure the wall area to be drilled is free from hidden electrical wires, water and gas pipes.
3. Use of tip-over restraints may only reduce, but not eliminate the risk of tip-over.
4. Unless specially designed to accommodate, do not set heavy objects on top of this product.
5. Place the heaviest items on the lowest shelf.
6. Never allow children to climb or bang on drawers, doors or shelves.

DE

Vielen Dank für Ihren Kauf von uns Produkten. Bitte kontaktieren Sie uns, wenn Sie Probleme mit Montage haben oder Ersatzteile benötigen. Wir Kundenservice ist für Sie da. Bitte geben Sie Ihren Benutzernamen oder Ihre Bestellnummer an, damit wir Sie besser unterstützen können.

WARNUNG







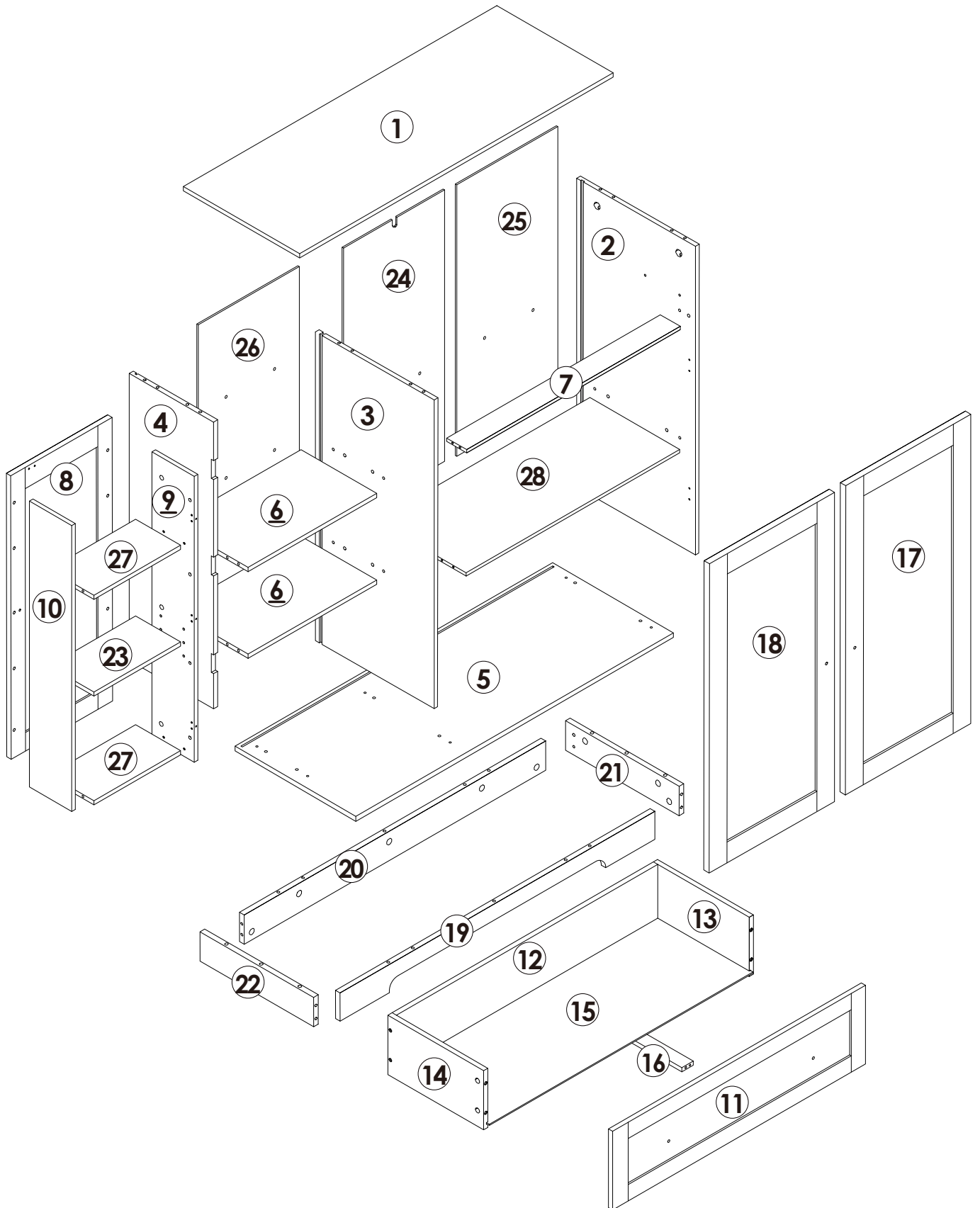

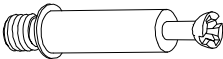
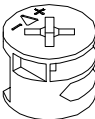
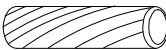

Bei unerwarteter Montage oder Verwendung können schwere oder tödliche Verletzung auftreten.

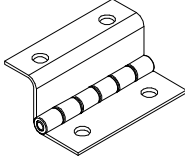
1. Legen Sie in den Montageprozess alle Teile weg von Babys oder Kindern.
2. Stellen Sie sicher, dass der gebohrte Wandbereich frei von verborgenen Stromkabeln, Wasser- und Gasleitungen ist, wenn Sie dieses Produkt an der Wand befestigen.
3. Die Verwendung von Kippsicherungen kann die Gefahr eines Kippens nur verringern, jedoch nicht beseitigen.
4. Setzen Sie bitte keine schweren Gegenstände auf dieses Produkt, es sei denn, dass das Produkt speziell für die Unterbringung konzipiert wird.
5. Legen Sie bitte die schwersten Gegenstände auf das unterste Regal.
6. Erlauben Sie nie Kindern, auf Schubladen, Türen oder Regale zu klettern oder zu knallen.

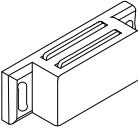
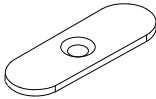
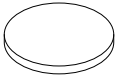
Parts List(EN) / Teile Liste(DE)

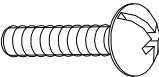
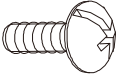
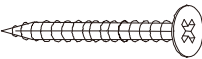

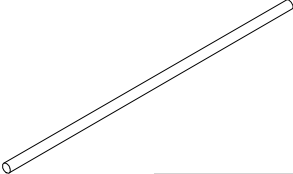
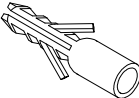
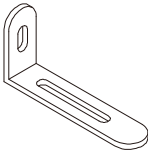
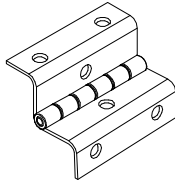
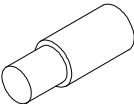

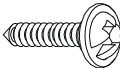
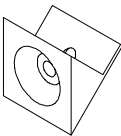
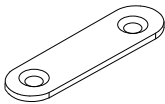
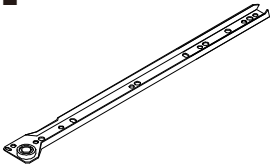
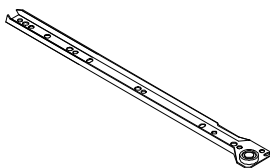
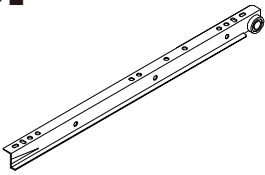
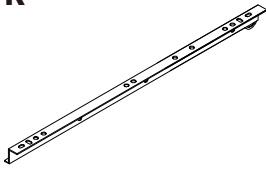

Parts List(EN) / Teile Liste(DE)

<p>A</p>  <p>M6×35mm 49+2PCS</p>	<p>B</p>  <p>Ø15×10mm 49+2PCS</p>	<p>C</p>  <p>Ø6×30mm 45+2PCS</p>	<p>D</p>  <p>M3×12mm 38+2PCS</p>
<p>E</p>  <p>4PCS</p>	<p>F</p>  <p>M3×14mm 18+2PCS</p>	<p>G</p>  <p>2PCS</p>	<p>H</p>  <p>2PCS</p>
<p>I</p>  <p>8+1PCS</p>	<p>J</p>  <p>5PCS</p>	<p>K</p>  <p>M4×18mm 3PCS</p>	<p>L</p>  <p>M4×10mm 2PCS</p>
<p>M</p>  <p>M4×35mm 13+1PCS</p>	<p>N</p>  <p>1PC</p>	<p>O</p>  <p>M4×12mm 1PC</p>	<p>P</p>  <p>L302mm 3PCS</p>
<p>Q</p>  <p>M6×30mm 1PC</p>	<p>R</p>  <p>1PC</p>	<p>S</p>  <p>3PCS</p>	<p>T</p>  <p>4PCS</p>
<p>U</p>  <p>M3×12mm 12+1PCS</p>	<p>V</p>  <p>M3×12mm 8+1PCS</p>	<p>W</p>  <p>14+1PCS</p>	<p>X</p>  <p>1PC</p>
<p>CL</p>  <p>L350mm 1PC</p>	<p>CR</p>  <p>L350mm 1PC</p>	<p>DL</p>  <p>L350mm 1PC</p>	<p>DR</p>  <p>L350mm 1PC</p>

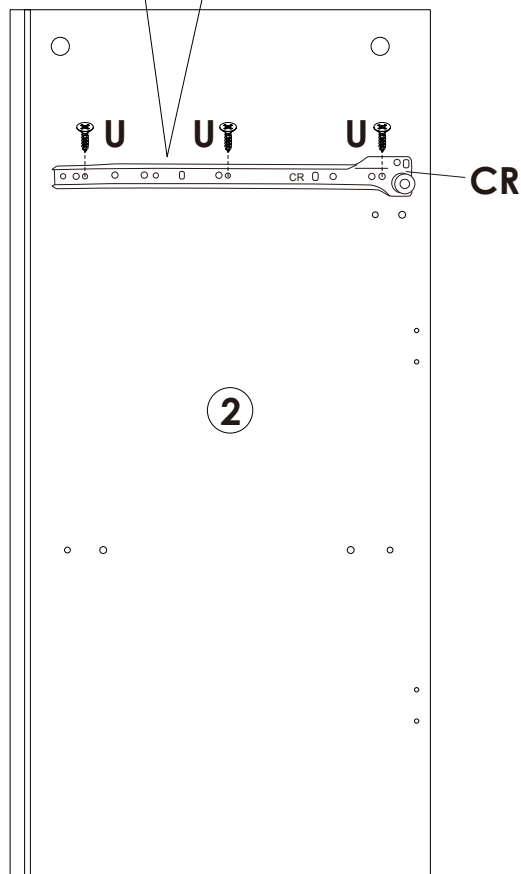
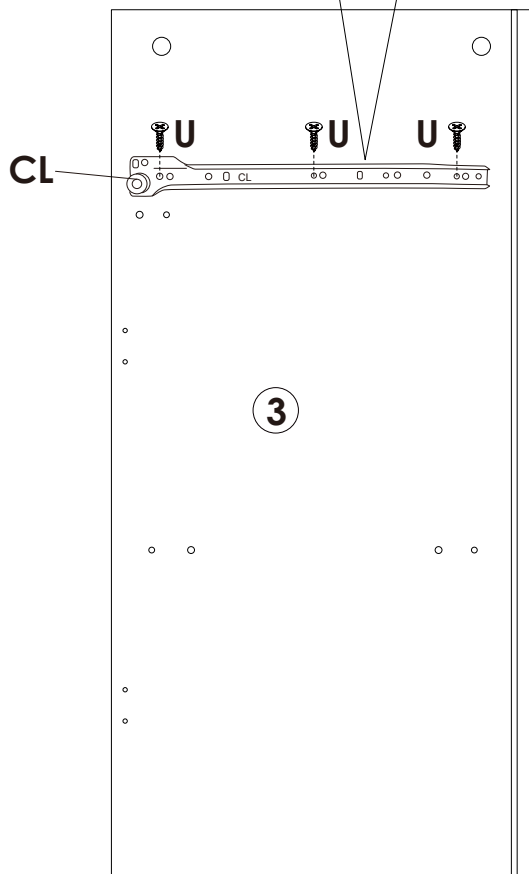
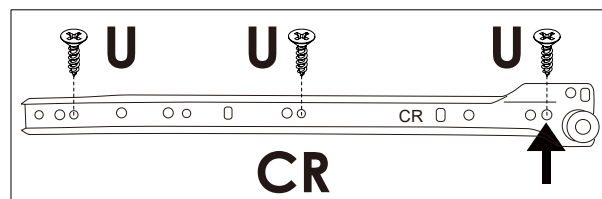
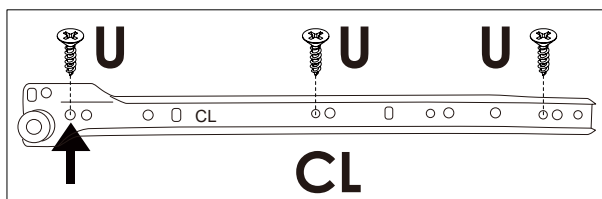
Assembly Steps(EN) / Montageschritte(DE)

STEP 1



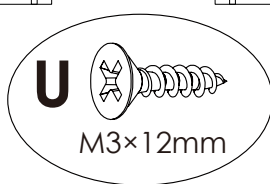

	U x 6PCS
	CL x 1PC
	CR x 1PC

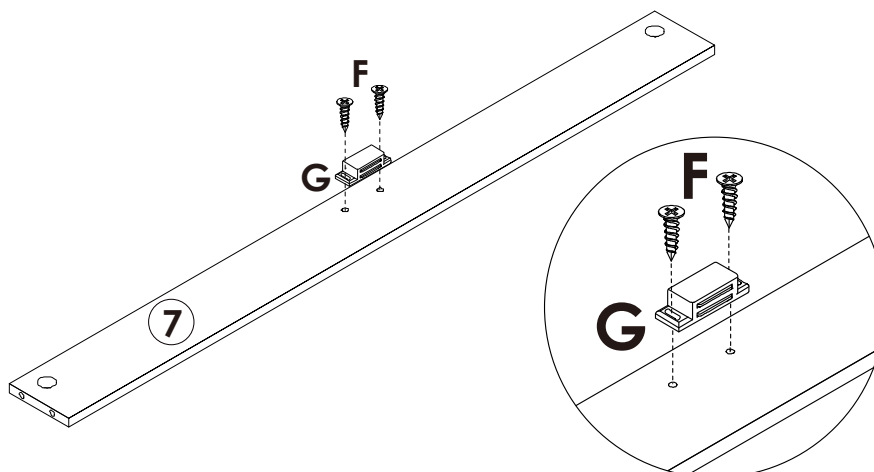

STEP 2



	F x 2PCS
	G x 1PC

Assembly Steps(EN) / Montageschritte(DE)

STEP 3

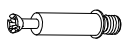
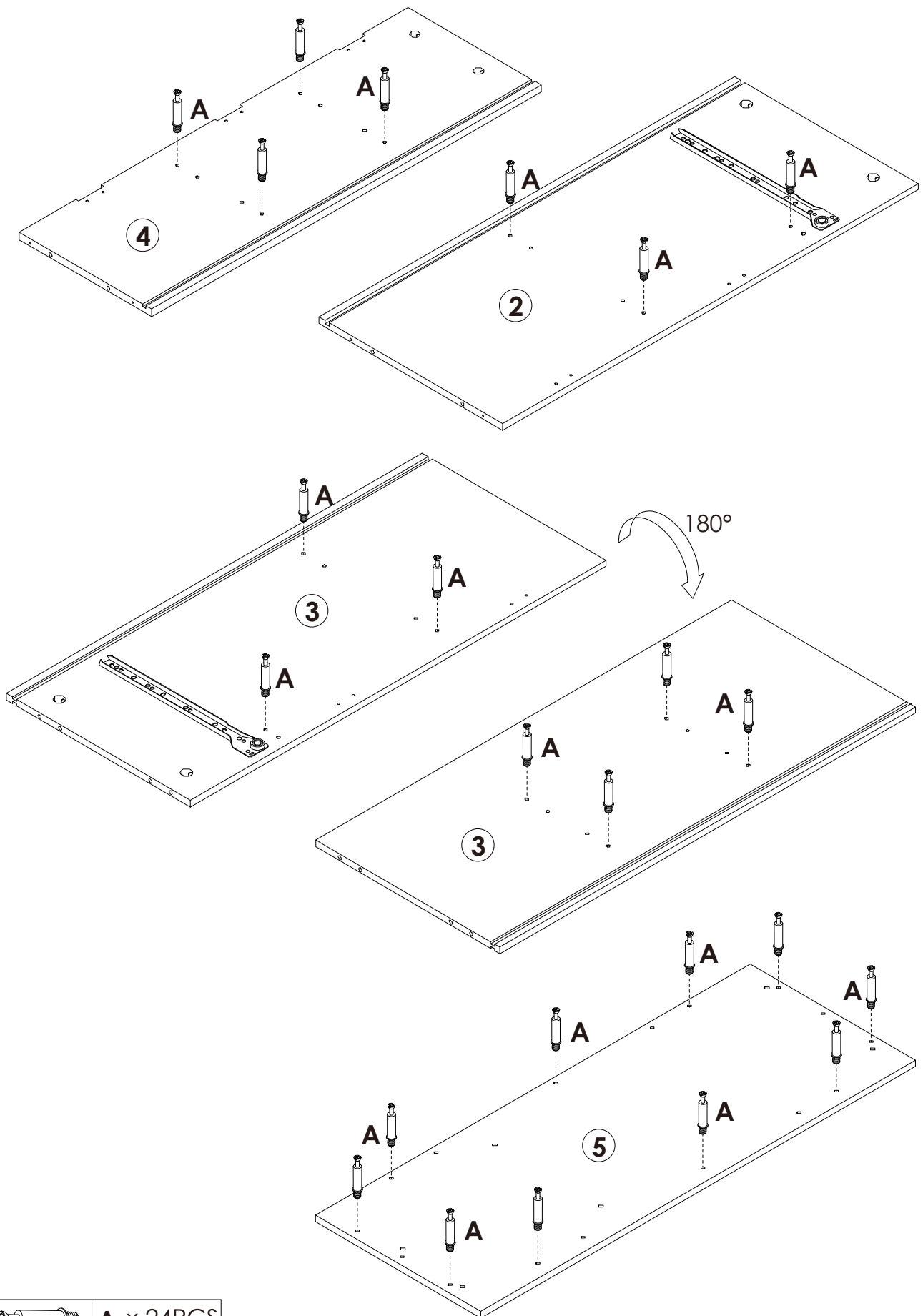



A x 24PCS

Assembly Steps(EN) / Montageschritte(DE)

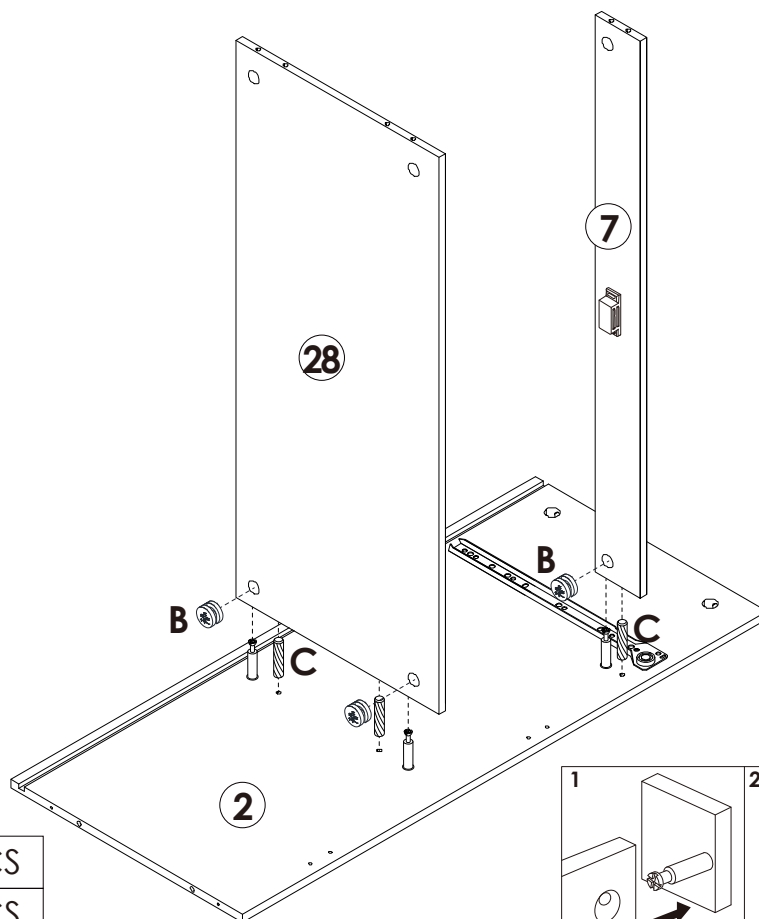

STEP 4

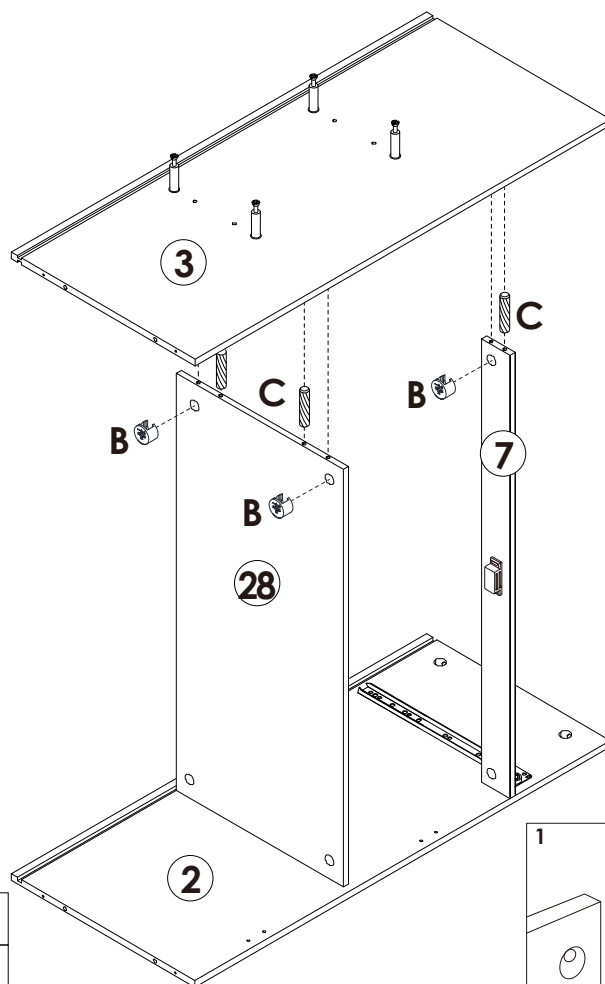

	B x 3PCS
	C x 3PCS

STEP 5





	B x 3PCS
	C x 3PCS

Assembly Steps(EN) / Montageschritte(DE)

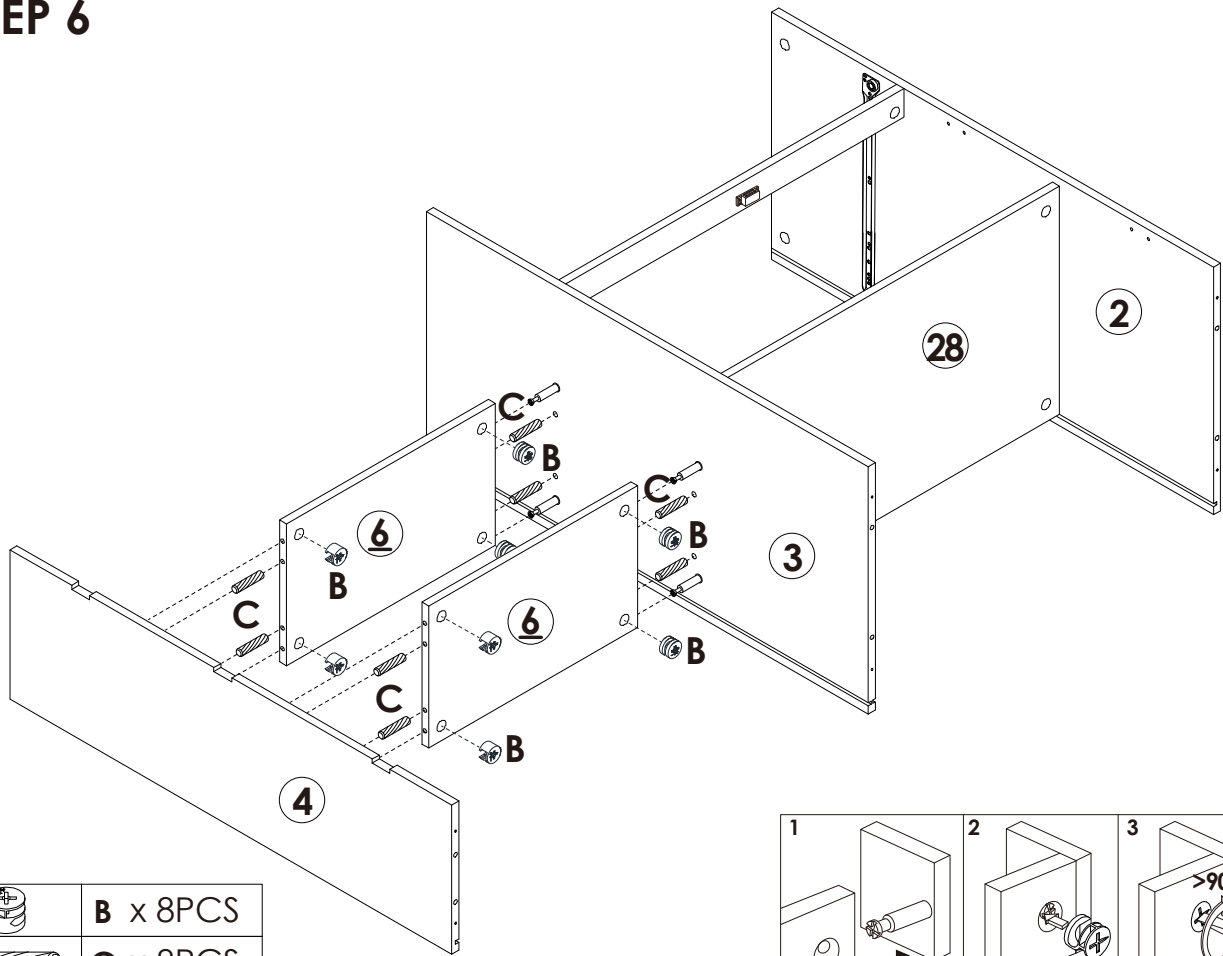

STEP 6

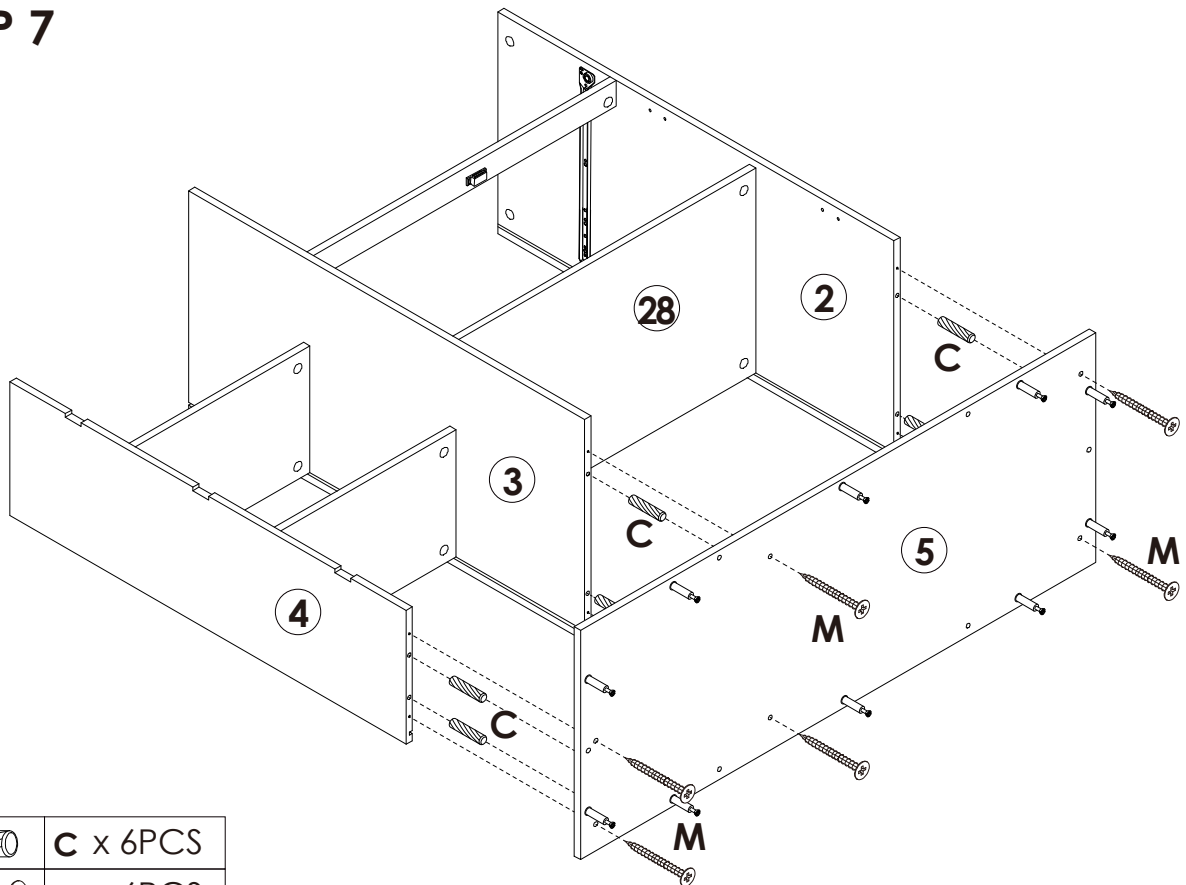

	B x 8PCS
	C x 8PCS

STEP 7



	C x 6PCS
	M x 6PCS

Assembly Steps(EN) / Montageschritte(DE)

STEP 8

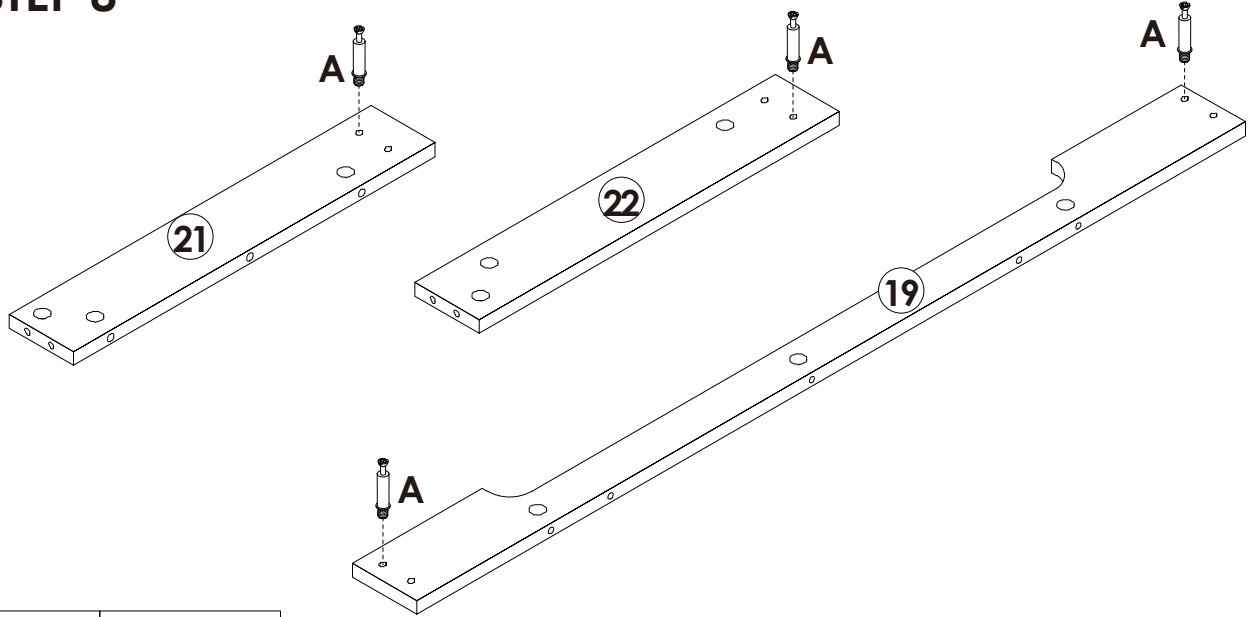

 **A x 4PCS**

STEP 9

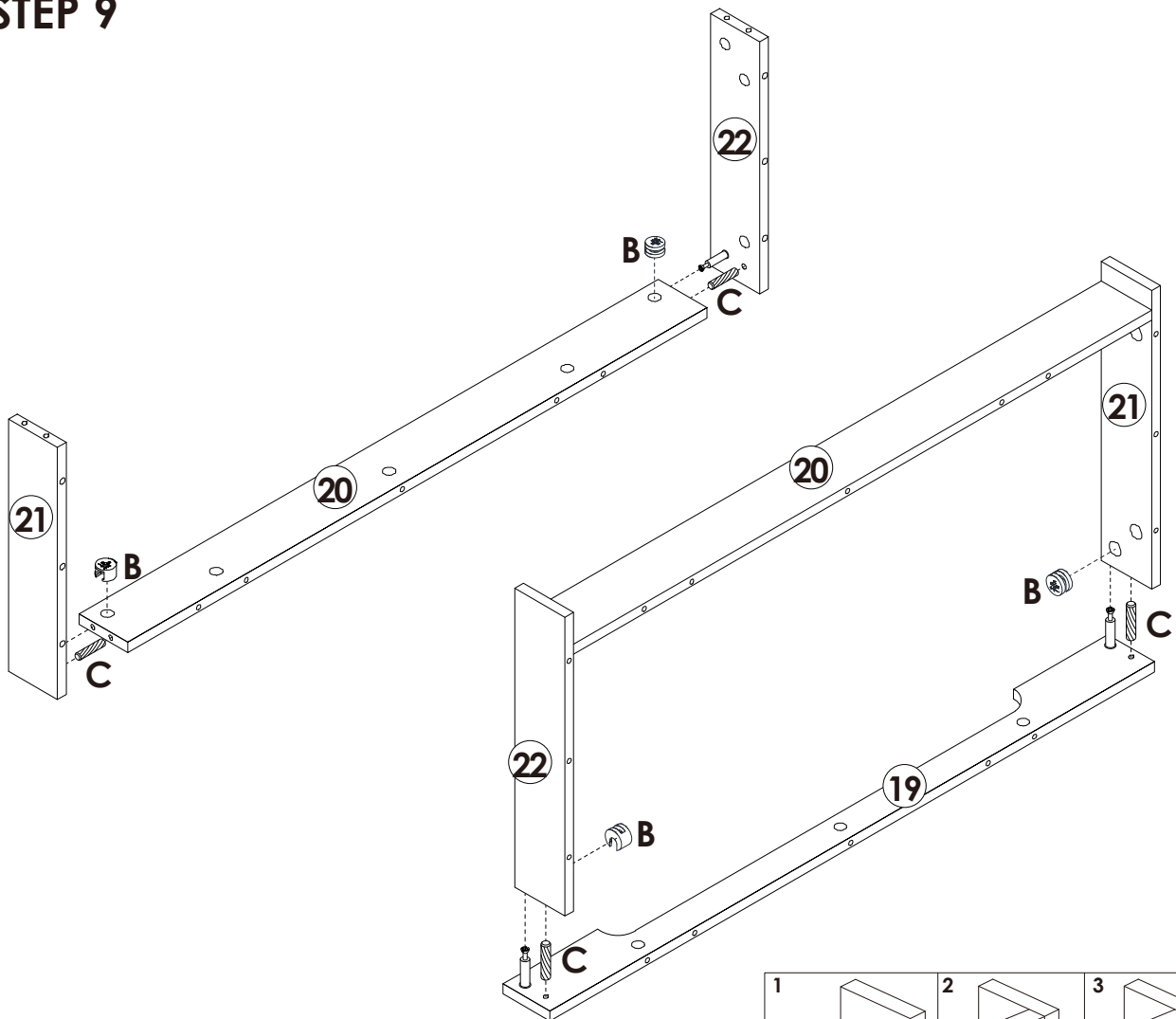

 **B x 4PCS**

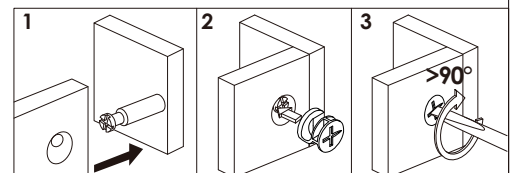

 **C x 4PCS**

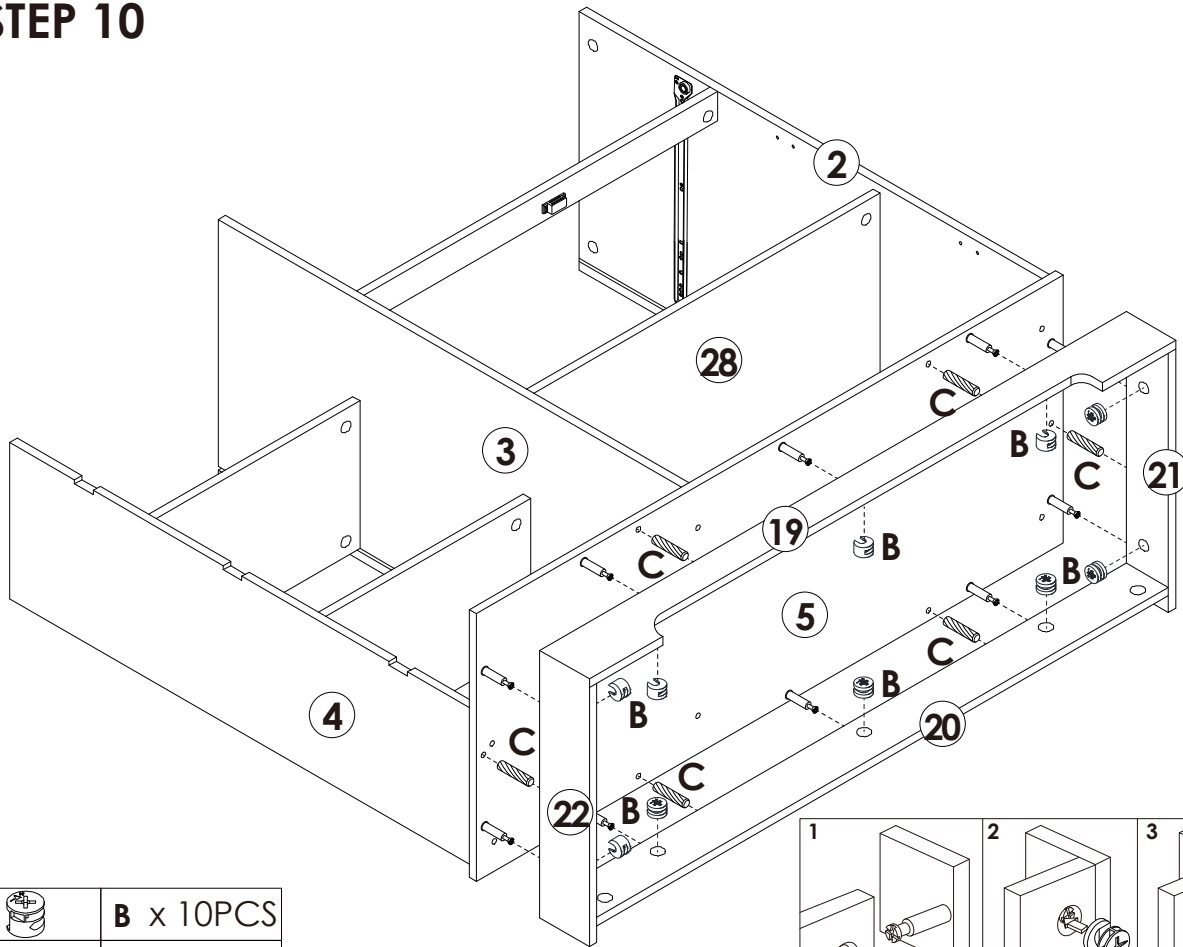

Assembly Steps(EN) / Montageschritte(DE)

STEP 10



	B x 10PCS
	C x 6PCS

STEP 11

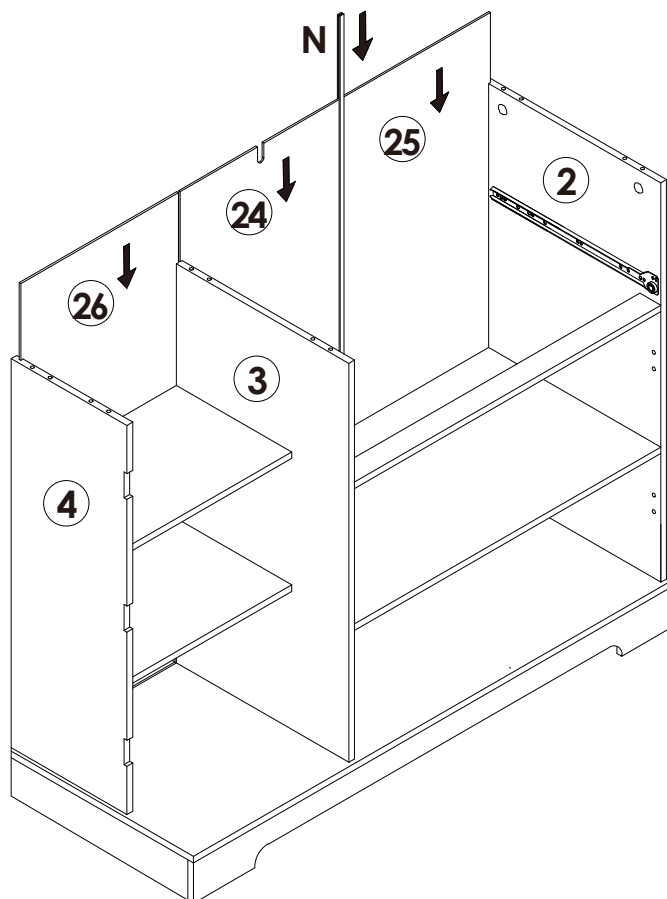
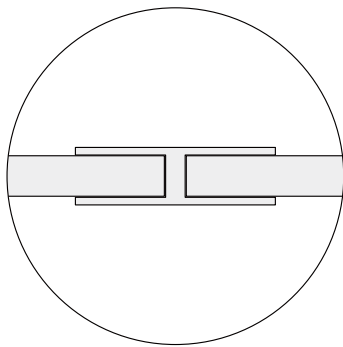





	N x 1PC
-------------------------------------------------------------------------------------	----------------

Assembly Steps(EN) / Montageschritte(DE)

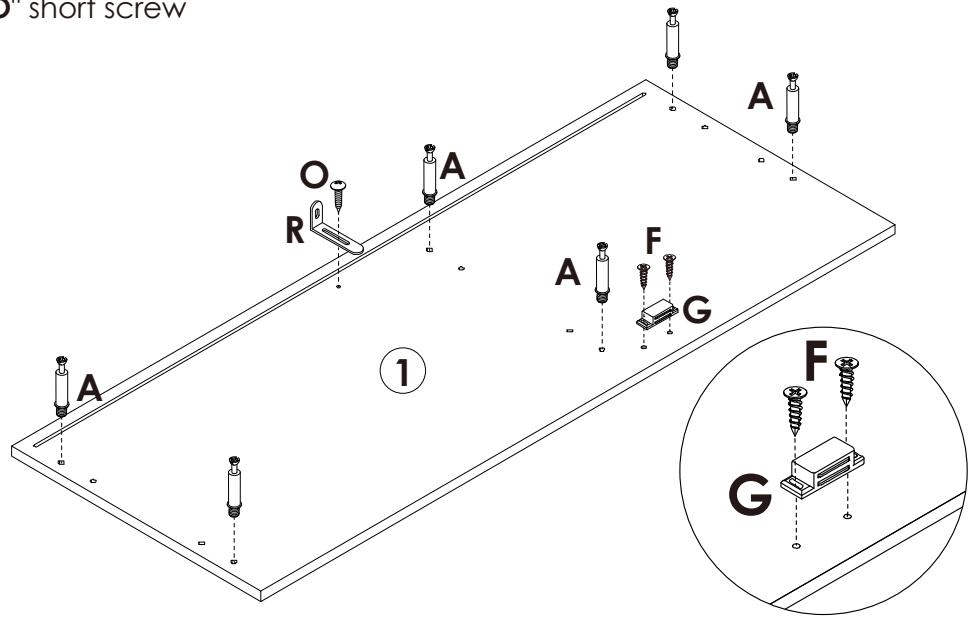
STEP 12

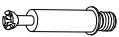

Lock the long side of the "R" L-shaped metal plate to the ① board with the "O" short screw

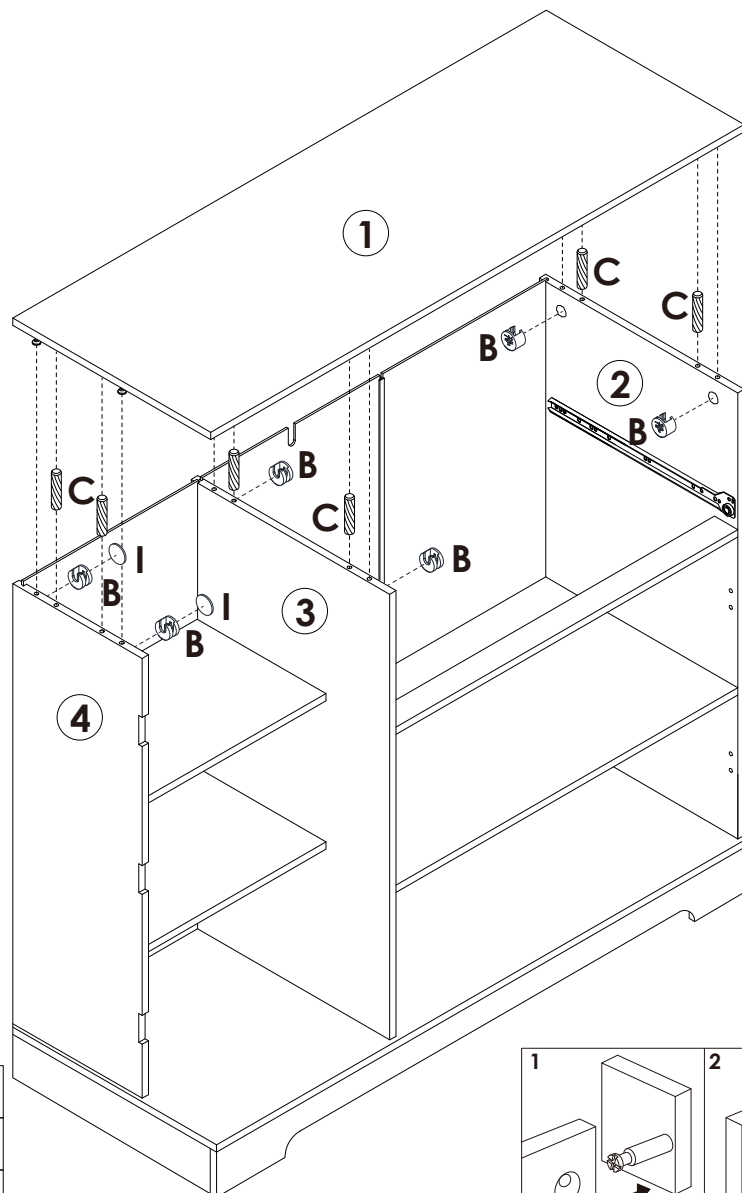

	A x 6PCS
	F x 2PCS
	G x 1PC
	R x 1PC
	O x 1PC

STEP 13



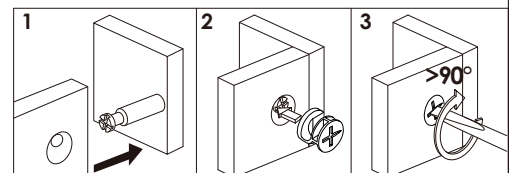

	B x 6PCS
	C x 6PCS
	I x 2PCS



Assembly Steps(EN) / Montageschritte(DE)

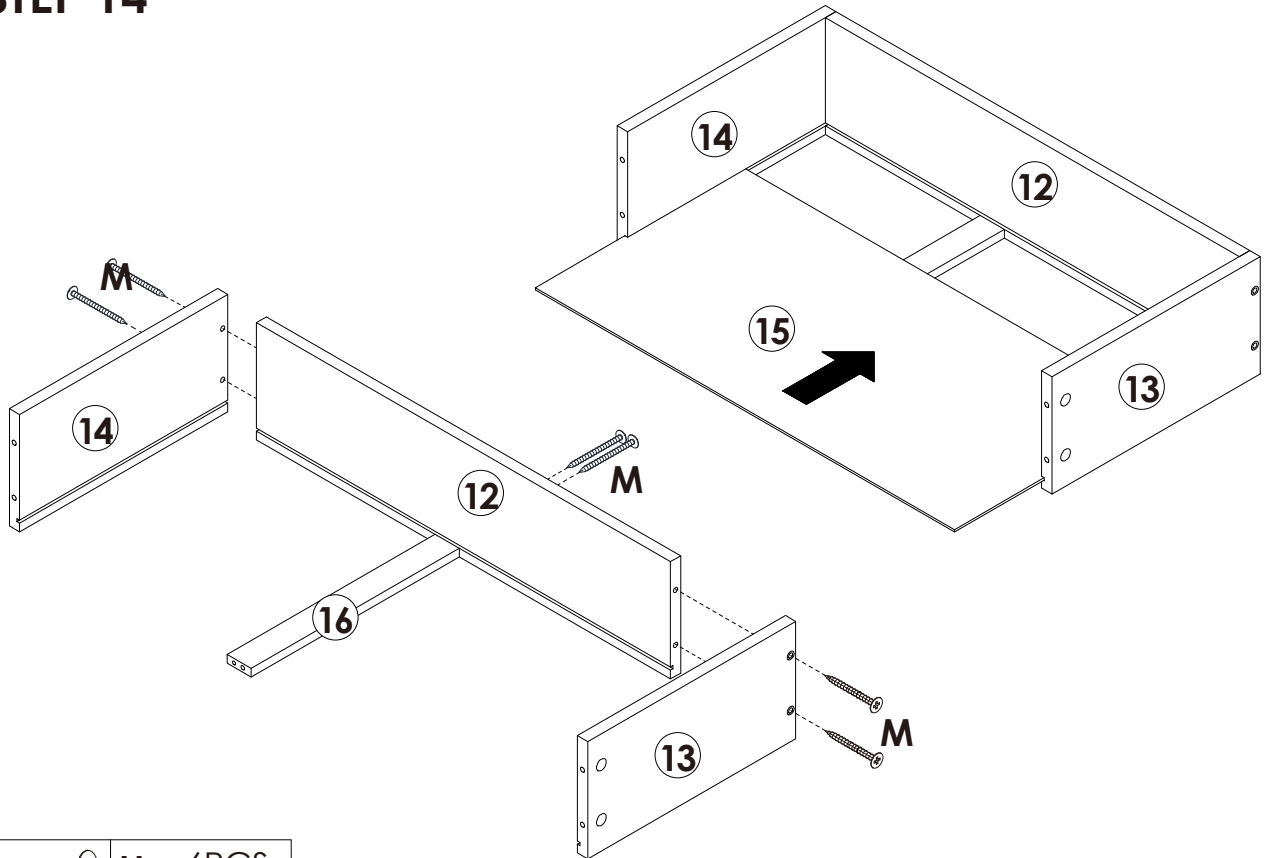



STEP 14

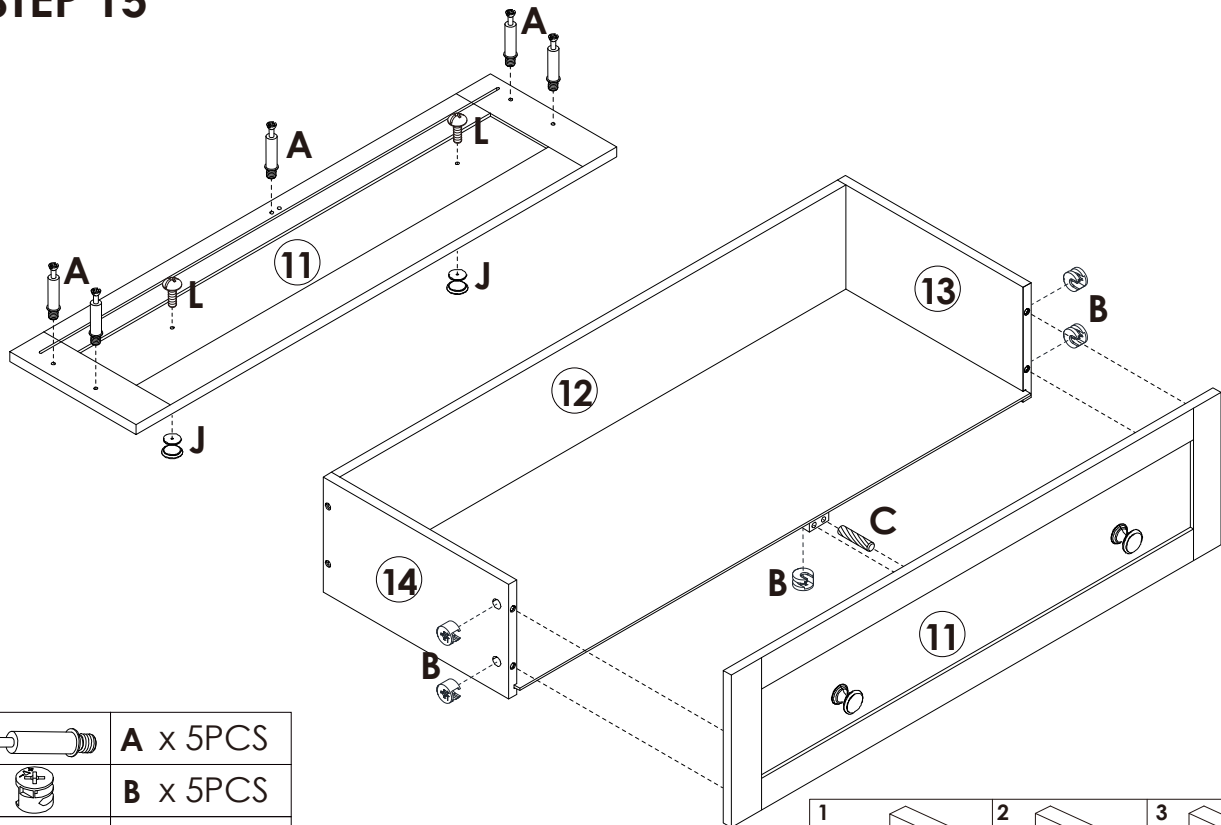

 M x 6PCS

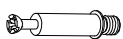
STEP 15





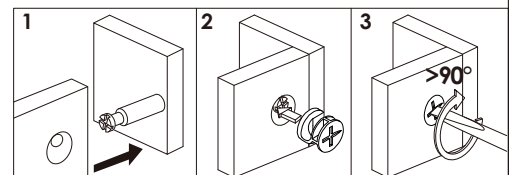

	A x 5PCS
	B x 5PCS
	C x 1PC
	J x 2PCS
	L x 2PCS

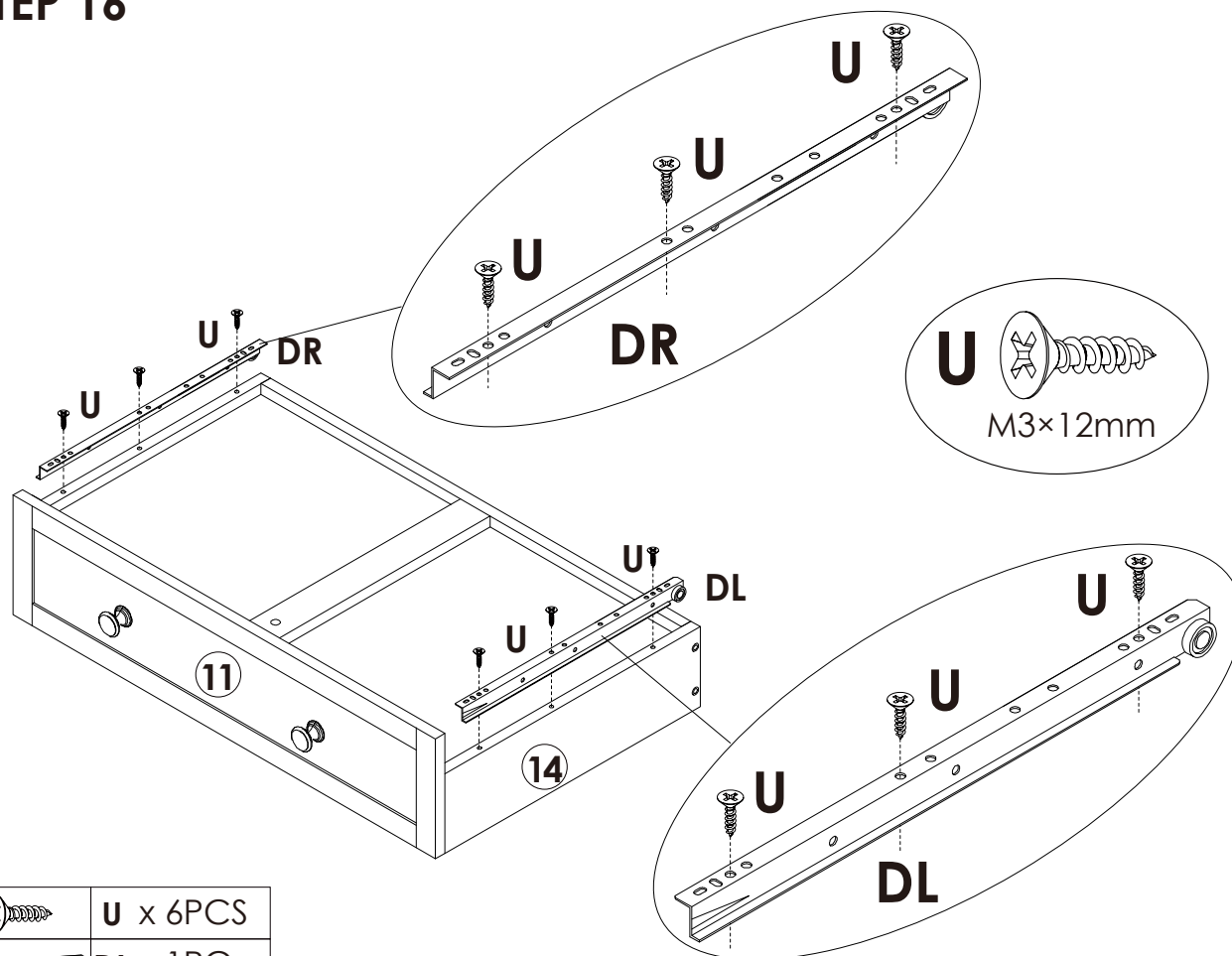

Assembly Steps(EN) / Montageschritte(DE)

STEP 16



	U x 6PCS
	DL x 1PC
	DR x 1PC

STEP 17

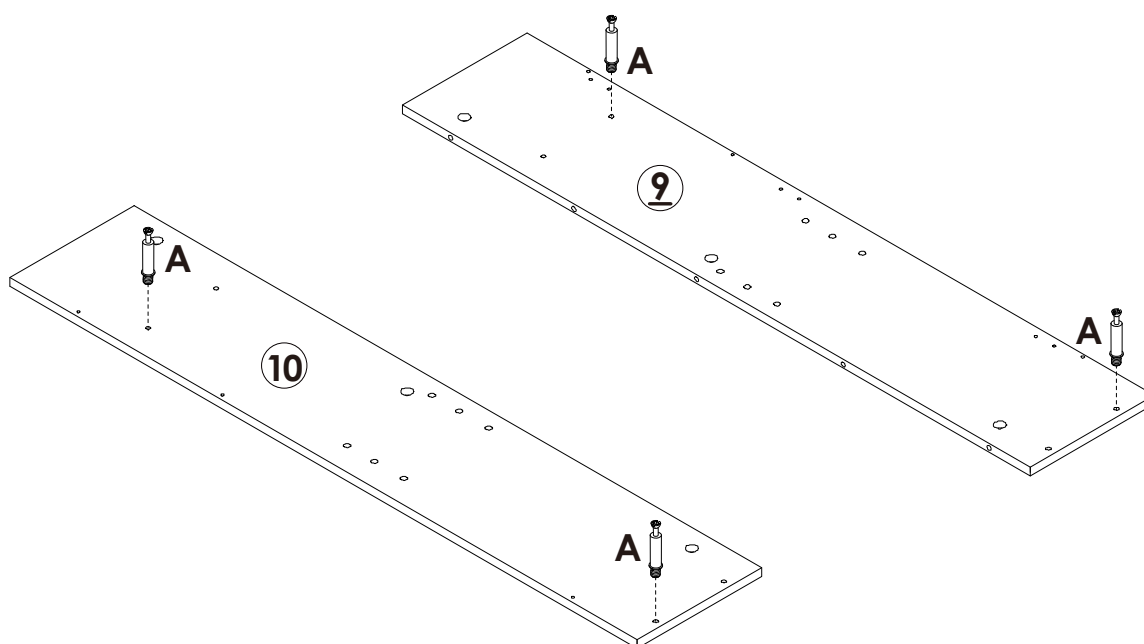



	A x 4PCS
-------------------------------------------------------------------------------------	-----------------

Assembly Steps(EN) / Montageschritte(DE)

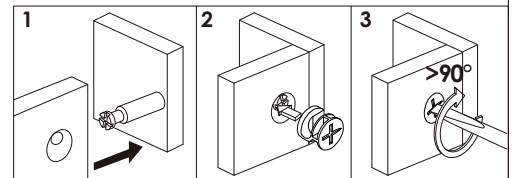
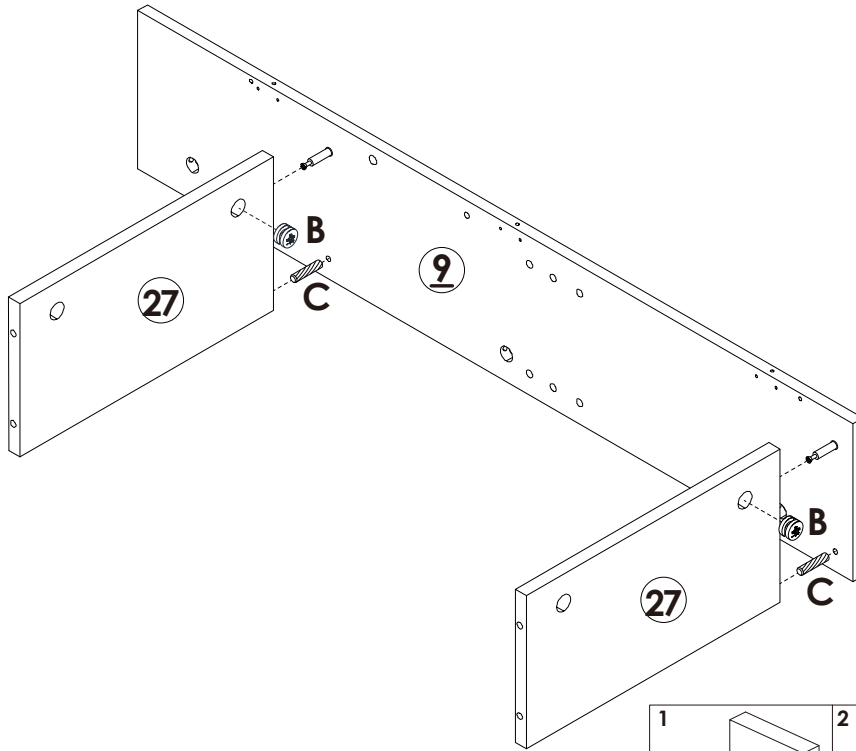

STEP 18

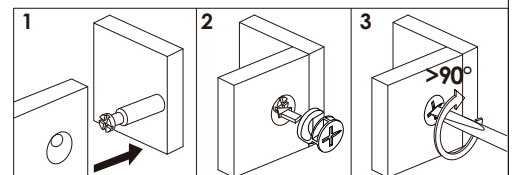
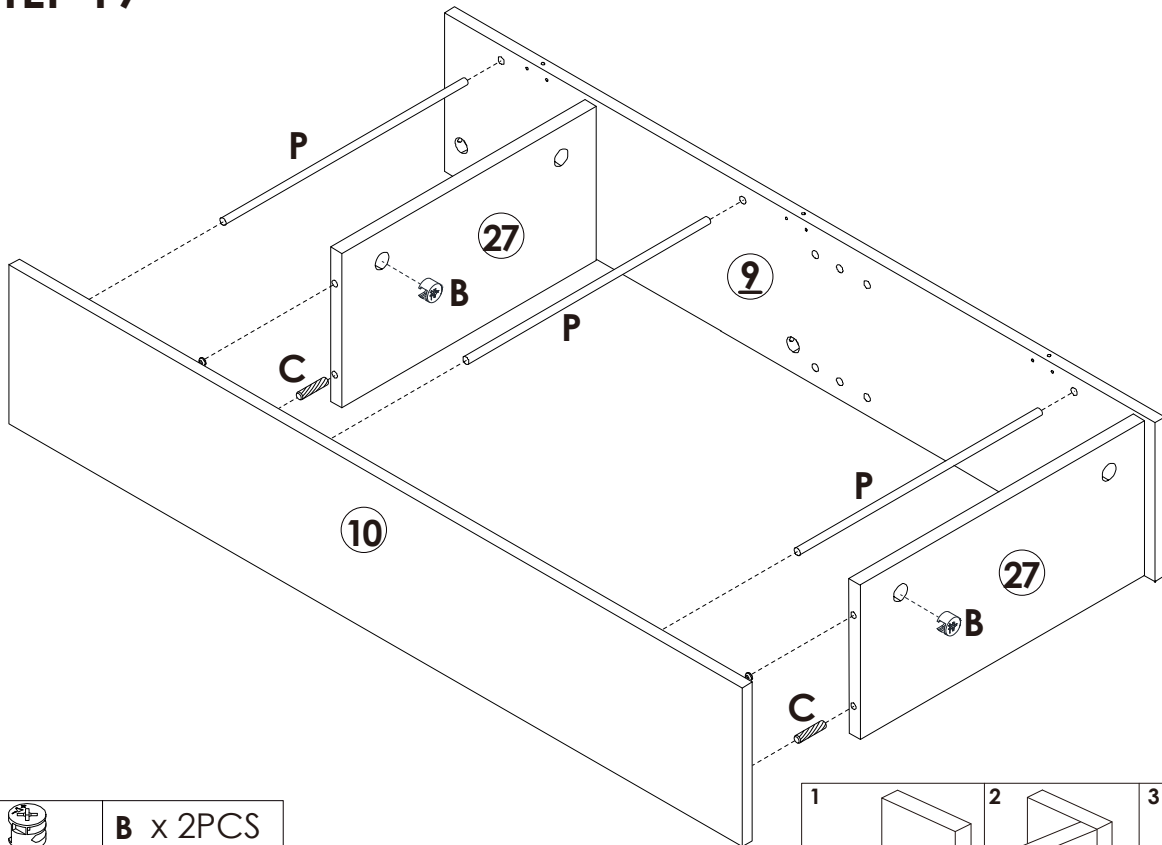

	B x 2PCS
	C x 2PCS

STEP 19



	B x 2PCS
	C x 2PCS
	P x 3PCS

Assembly Steps(EN) / Montageschritte(DE)

STEP 20

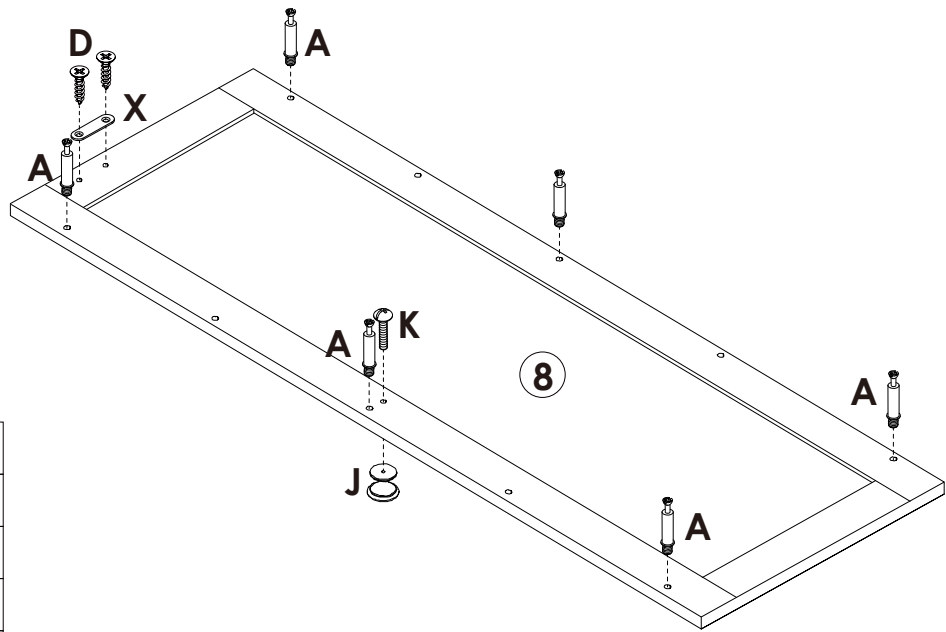
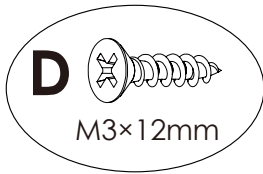

	A x 6PCS
	D x 2PCS
	X x 1PC
	J x 1PC
	K x 1PC

STEP 21

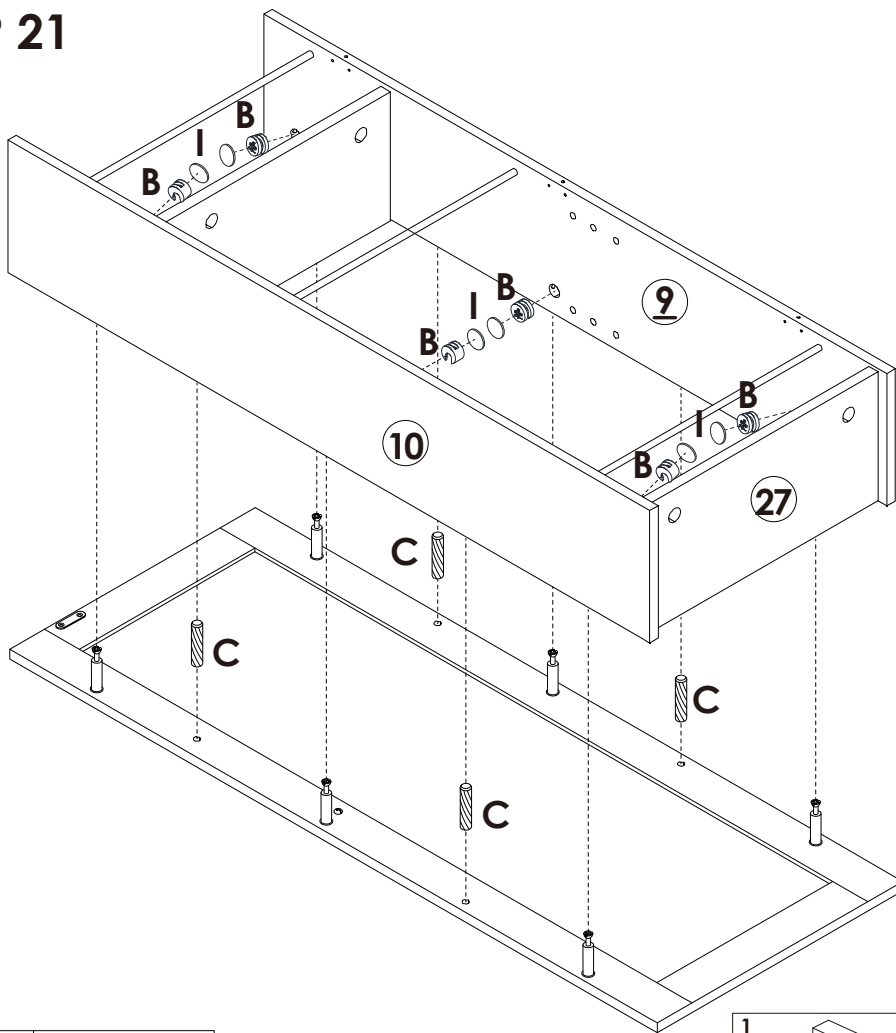

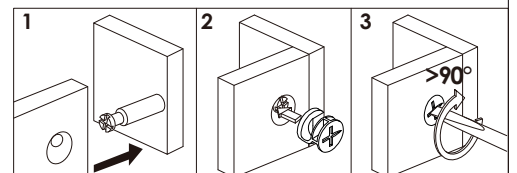

	B x 6PCS
	C x 4PCS
	I x 6PCS



Assembly Steps(EN) / Montageschritte(DE)

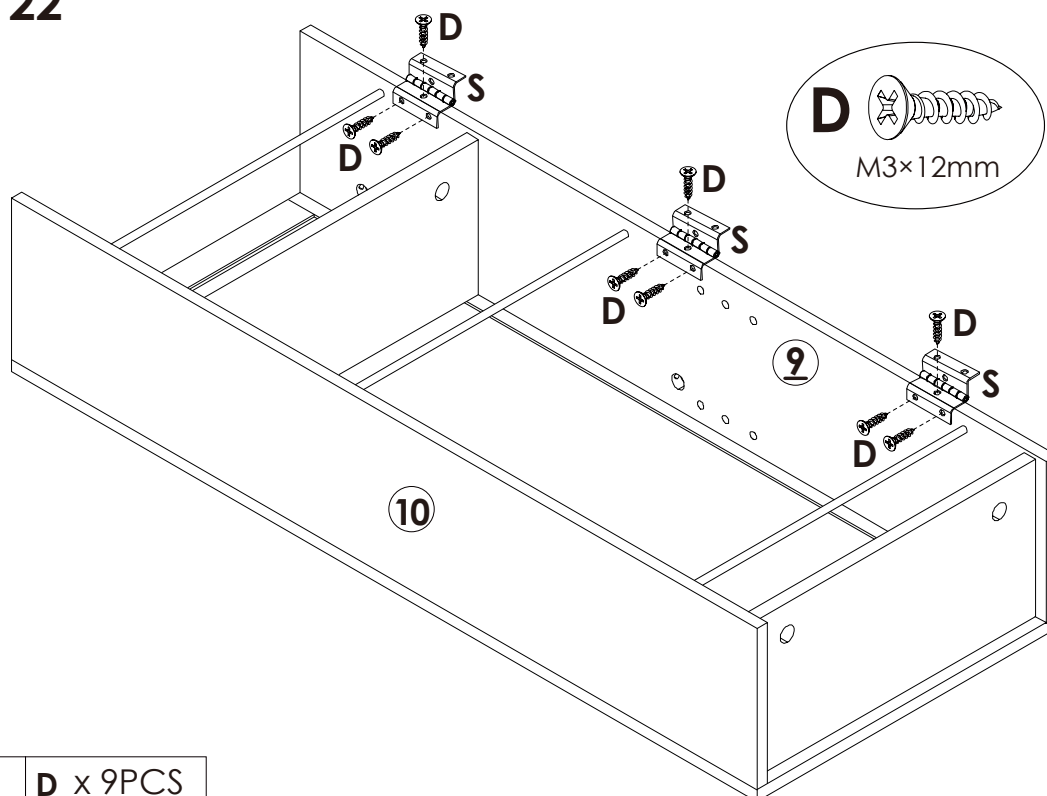



STEP 22

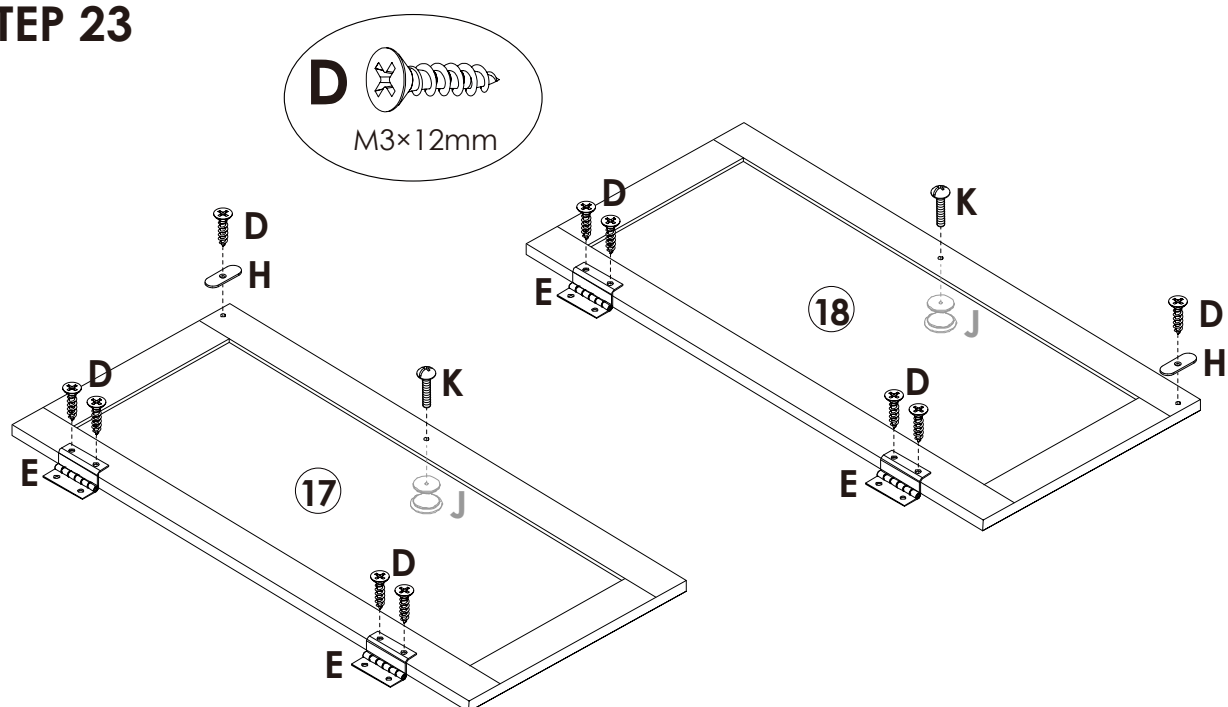

	D x 9PCS
	S x 3PCS

STEP 23



	D x 10PCS
	E x 4PCS
	H x 2PCS
	J x 2PCS
	K x 2PCS

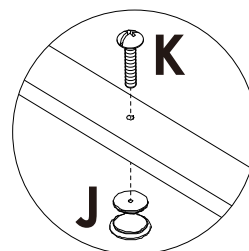
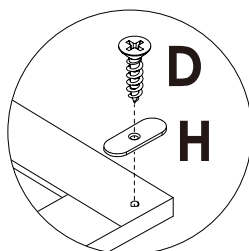
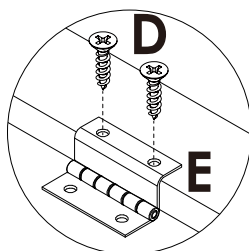

Assembly Steps(EN) / Montageschritte(DE)

STEP 24

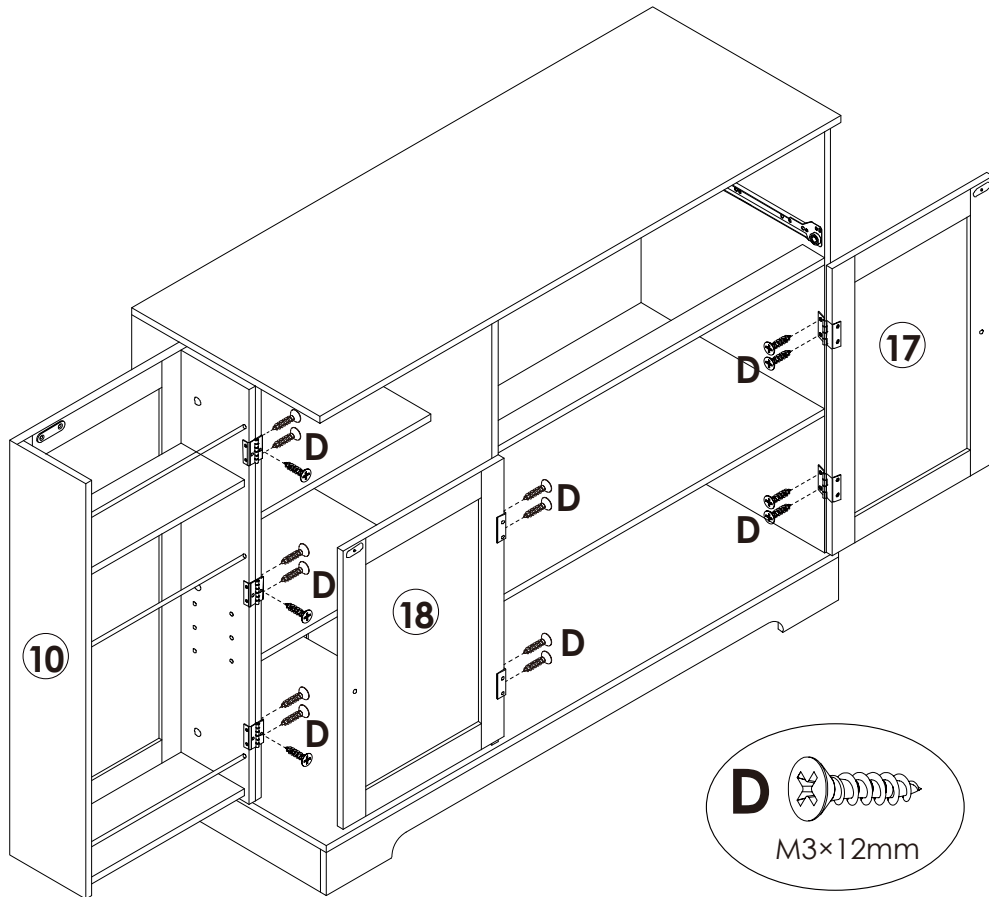

D x 17PCS

STEP 25

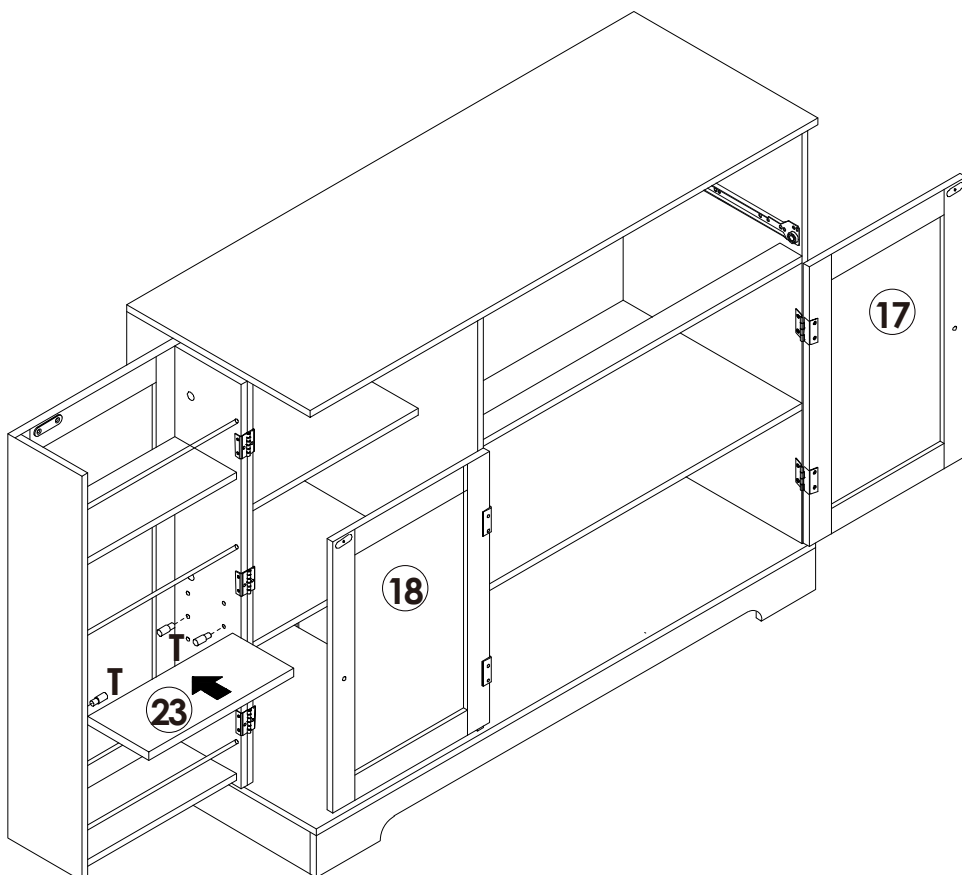



T x 4PCS

Assembly Steps(EN) / Montageschritte(DE)

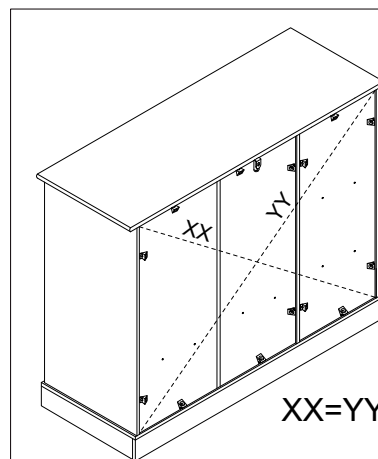
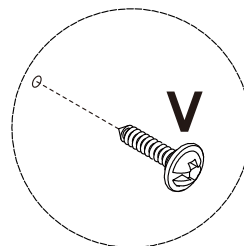
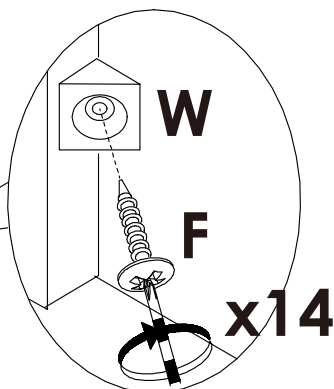
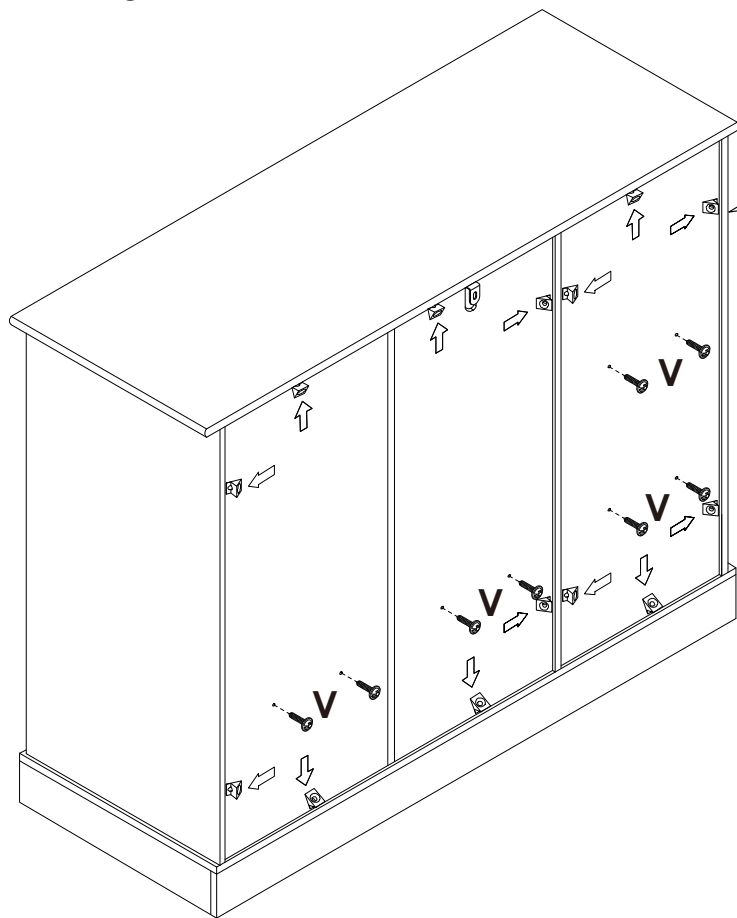
STEP 26



	F x 14PCS
	V x 8PCS
	W x 14PCS

STEP 27

WALL

Drill a hole on the wall at the required position for anti-falling device installation.

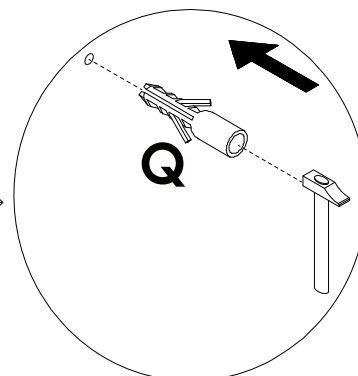
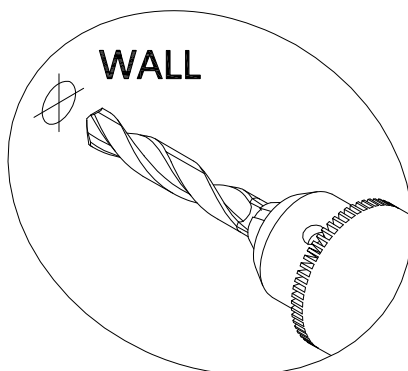
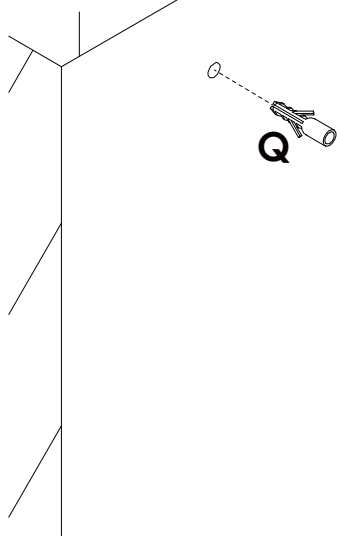

	Q x 1PC
-------------------------------------------------------------------------------------	---------

Assembly Steps(EN) / Montageschritte(DE)

STEP 28

Move the cabinet to the required position, use the "M" long screw to fix the cabinet to the wall.

WALL

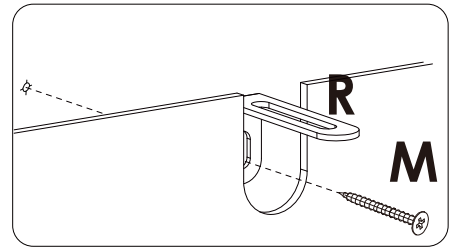
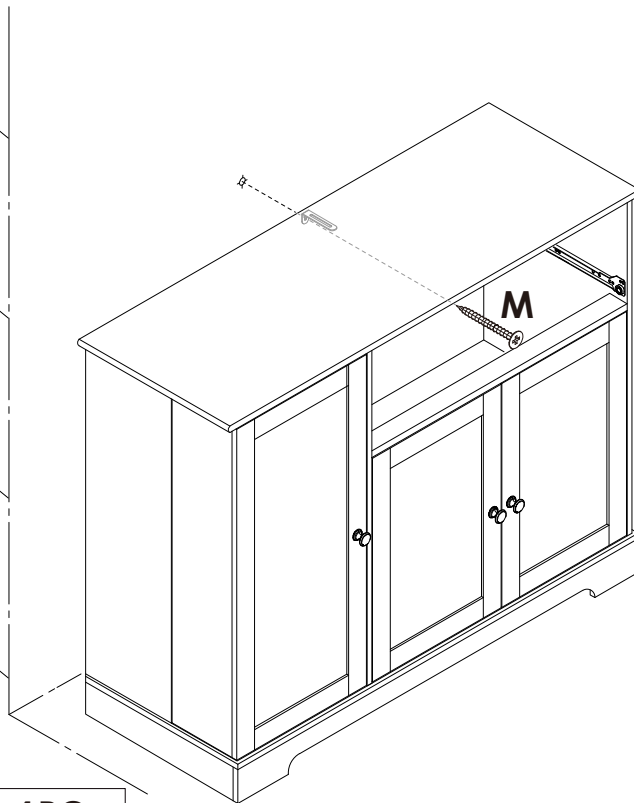

 M x 1PC

STEP 29

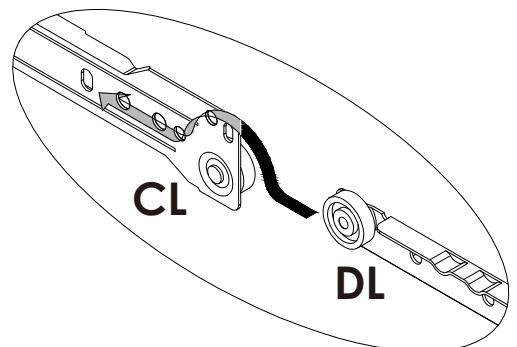
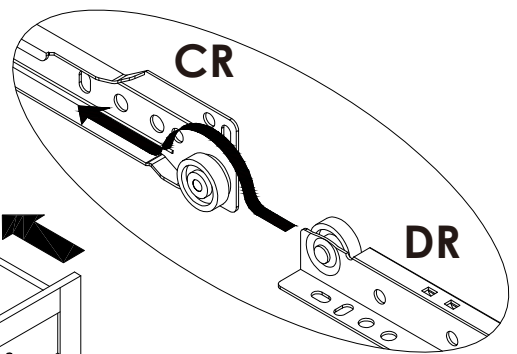
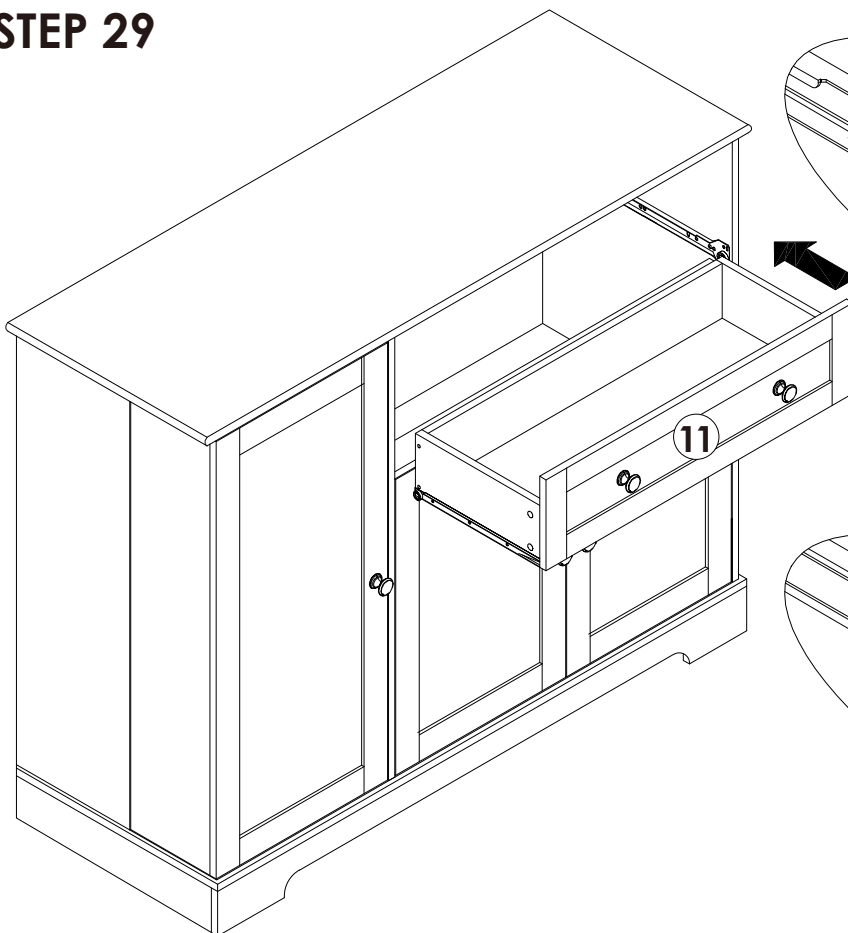



WARNING



Children have died from furniture tipover. To reduce the risk of furniture tipover:

- **ALWAYS** install tipover restraint provided.
- **NEVER** allow children to stand, climb or hang on drawers, doors, or shelves.
- **NEVER** open more than one drawer at a time.
- **Place heaviest items in the lowest drawers.**