

ASSEMBLY INSTRUCTIONS

## Swivel Recliner & Footstool





This product is designed to seat people up to a maximum of 115kgs (18 stone)

Check and re-tighten parts/nuts & bolts every three months



#### F I R E R E T A R D A N C Y

GFA's leathers/bonded leathers/PUs/fabrics meet the requirements of BS5852 Part 1 Source 0 ( Cigarette) Ignition Source 1 (Match) as laid out in the UK Furniture and Furnishings (Fire) ( Safety) Regulations 1988 with amendments in 1989, 1993 and 2010.

**Please retain these instructions for future reference and in case of any queries, please quote the following batch number to your retailer.**

**(The batch number is also located on the underside of the seat pad or footstool pad)**

**IMPORTANT:** Please read this manual carefully before beginning assembly of this product. Keep this manual for future reference.

## S A F E T Y   I N F O R M A T I O N

Identify all the parts and hardware.

Do not discard of the packaging until you have checked that you have all of the parts and hardware required.

Hardware package may have spare parts.

**WARNING:**

This item contains small parts which can be swallowed by children and pets. Keep children and pets away during assembly.

To avoid danger of suffocation, always keep plastic bags away from children and pets.

We recommend that you assemble this unit on a carpeted floor to avoid scratches.

We do not recommend the use of power tools for assembly as this could damage the unit. Only use manual tools.

Requires 2 people for ease of assembly.

## C A R E   A N D   M A I N T E N A N C E

Wipe regularly with clean water and a damp, clean, soft white cloth

General cleaning can be done as needed with a mild detergent and water solution. Always rinse with clean water and dry

For heavy soiling, dampen a soft white cloth or soft bristle brush. Use care as scrubbing can damage the surface

More difficult stains can be treated, but this should be occasional, not daily, cleaning



**ANY** cleaning solution used must be removed with clean water and a clean white cloth

Cleaning residue left on the material can cause it to dry out and crack, or affect the colour

**DO NOT** use any cleaners with corrosive ingredients (lye, acids or ammonia).

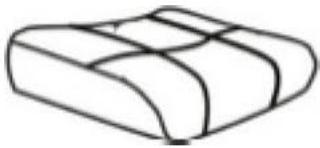
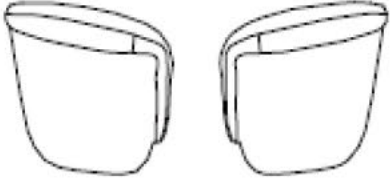
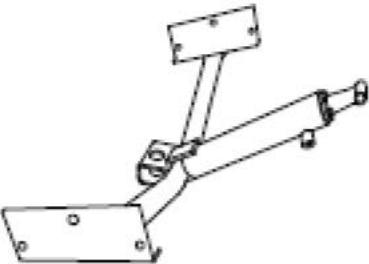

# PRE - ASSEMBLY INFORMATION

## PARTS DESCRIPTION

<p>A</p>  <p>Back cushion Qty1</p>	<p>B</p>  <p>Seat pad Qty1</p>	<p>C</p>  <p>LHF &amp; RHF arm Qty 1 set</p>
<p>D</p>  <p>U frame Qty1</p>	<p>E</p>  <p>Footstool pad Qty1</p>	<p>F</p>  <p>X5 Chair leg Qty5</p>



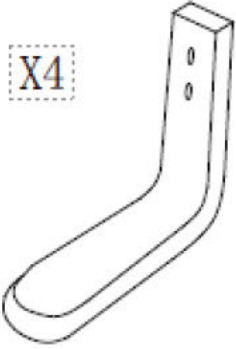
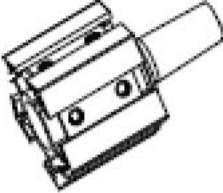
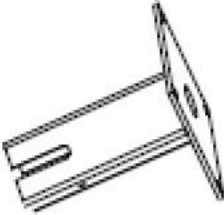

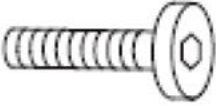
# PRE - ASSEMBLY INFORMATION

## PARTS DESCRIPTION

<p>G</p> <p>X4</p>  <p>Footstool leg Qty4</p>	<p>H</p>  <p>Chair spindle Qty1</p>	<p>I</p>  <p>Footstool spindle Qty1</p>
<p>J</p>  <p>Adjustable handle Qty1</p>	<p>K</p>  <p>Screws Qty12</p>	<p>L</p>  <p>Screws Qty18</p>

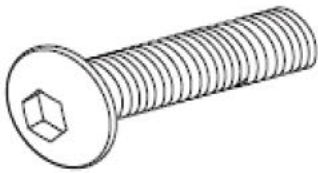
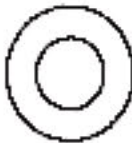
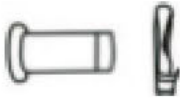
# PRE - ASSEMBLY INFORMATION

## PARTS DESCRIPTION

<p>M</p>  <p>Screws Qty2</p>	<p>N</p>  <p>Washer Qty18</p>	<p>O</p>  <p>Connection &amp; locking clip Qty2</p>
<p>P</p>  <p>Screw with locking nut Qty1</p>	<p>Q</p>  <p>Allen wrench Qty1</p>	<p>R</p>  <p>Allen key Qty1</p>

# PRE - ASSEMBLY INFORMATION

## PARTS DESCRIPTION

<p>S</p>  <p>Footstool plate Qty4</p>		

# ASSEMBLY

## STEP 1

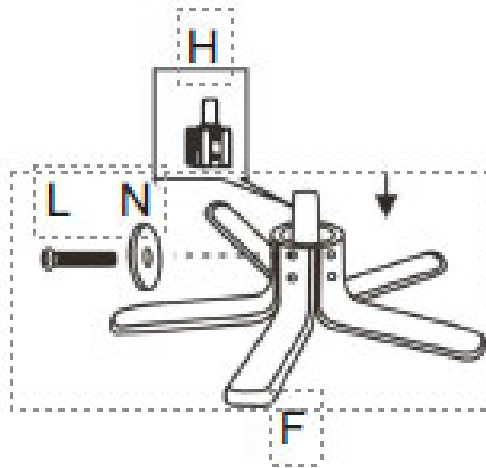

## STEP 2

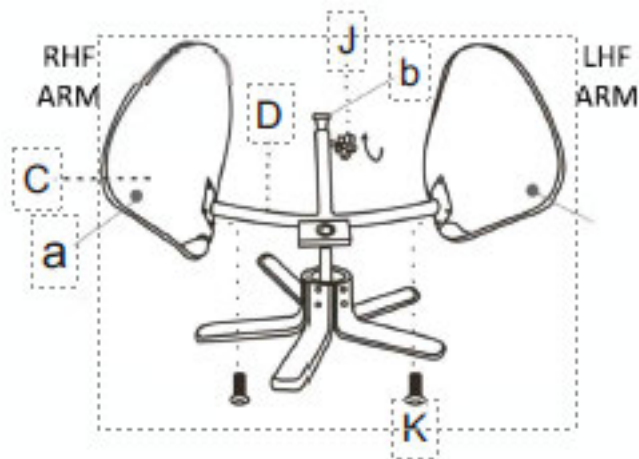

Please ensure that the holes (A) for the backrest fitting are at the rear of the base and opposite the adjustment bar (B). Do not tighten screws until product is fully assembled.

# ASSEMBLY

## STEP 3

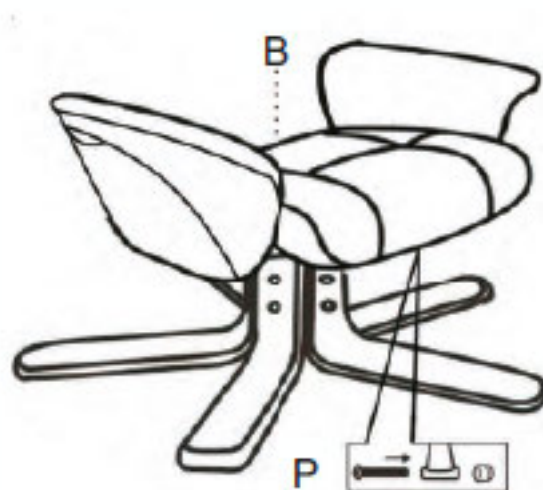

## STEP 4

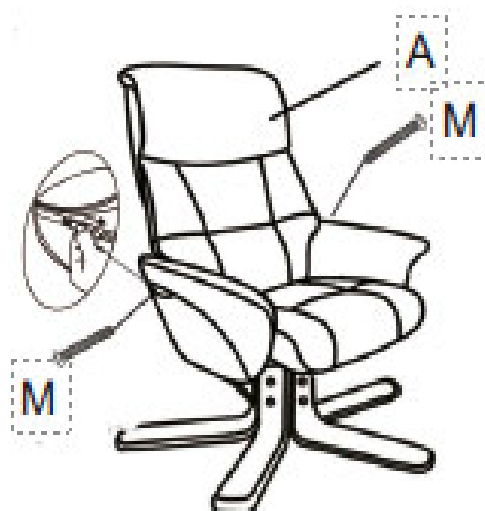

# ASSEMBLY

## STEP 5



## STEP 6

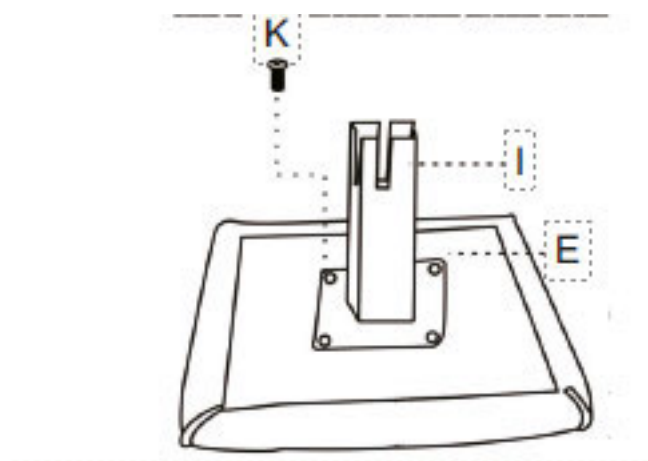

# ASSEMBLY

## STEP 7

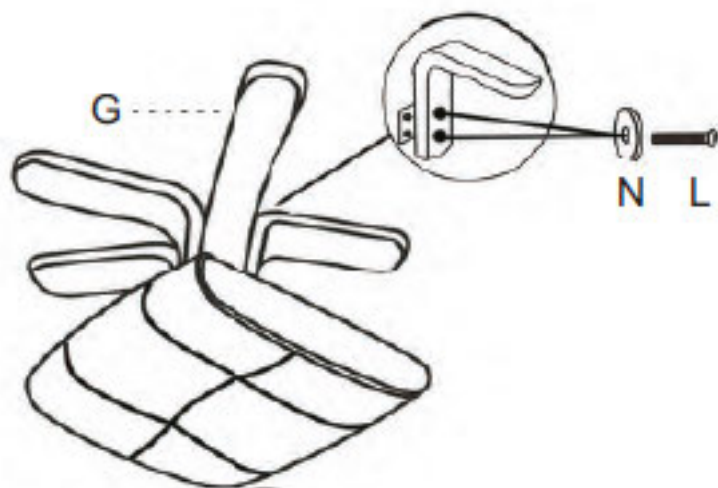

## STEP 8



