

SOU130S1



Category	30"
Product family	Oven
Power supply	Electrical
Power supply	Electricity
Cooking method	Thermo-ventilated
Cleaning system	Self-cleaning
EAN code	8017709287351



Aesthetic

Aesthetics	Linea	Silkscreen color	White
Color	Silver	Silkscreen type	Symbols and wordings
Design	Flat	Door	Full-glass
Material	Glass	Handle	Linea-design
Glass type	Stopsol	Logo	Silkscreened

Controls

Display technology	TFT	No. of display languages	6
Controls setting	Full-touch	Display languages	Italiano, English (UK), English (US), Français (FR), Español (ES), Deutsch (DE)

Programs / Functions

No. of cooking functions	9
Automatic programmes	70

Traditional cooking functions

Static	Fan-assisted	True European convection
Turbo	Large grill	Fan grill (large)
Bottom	Convection bottom	Circular heating element + Bottom

Other functions

Defrost	Proof	Keep-warm
Sabbath	Dehydrate	

Cleaning functions

Self-cleaning cycle

Options

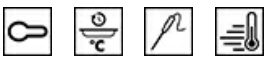

Time-setting options	Delayed start and automatic shut-off when cooking ends	Other options	Keep-warm
Minute minder	Yes	Cooking with food probe	Yes
Timer	1	Rapid pre-heating	Yes
Child safety lock	Yes		

Technical Features



Minimum Temperature	86 °F	Circular heating element - Power	1300 W
Maximum temperature	554 °F	Circular heating element 2 - Power	1300 W
No. of shelves	6	Heating elements stop when door is opened	Yes
Fan	Double fan	Door opening	Standard opening
No. of lights	3	Removable door	Yes
Lighting	Halogen	Total no. of door glasses	4
Replaceable light	Yes	Cooling system	Tangential
Light power	20 W	Door lock during self-cleaning cycle	Yes
Light on when door is open	Yes	Inner cavity dimensions (HxWxD)	410x610x415; mm
Lower heating element power	3000 W	Temperature control	Electronic
Upper heating element - Power	1032 W	Cavity material	Enamel
Large grill - Power	3500 W		

Performance / Energy Label



Volume of the cavity 3.64 cu. ft. Number of cavities 1

Accessories Included



Rack with back and side stop	2	Telescopic Guide rails, total Extraction	1
Enameled 0.8"-deep tray	1	Temperature probe	Yes, single-point probe
Insert grid	1		

Electrical Connection

Voltage	240-208 V	Frequency	60 Hz
Current	15,6 A	Power cord length	78 3/4 "
Nominal power	3535 W		

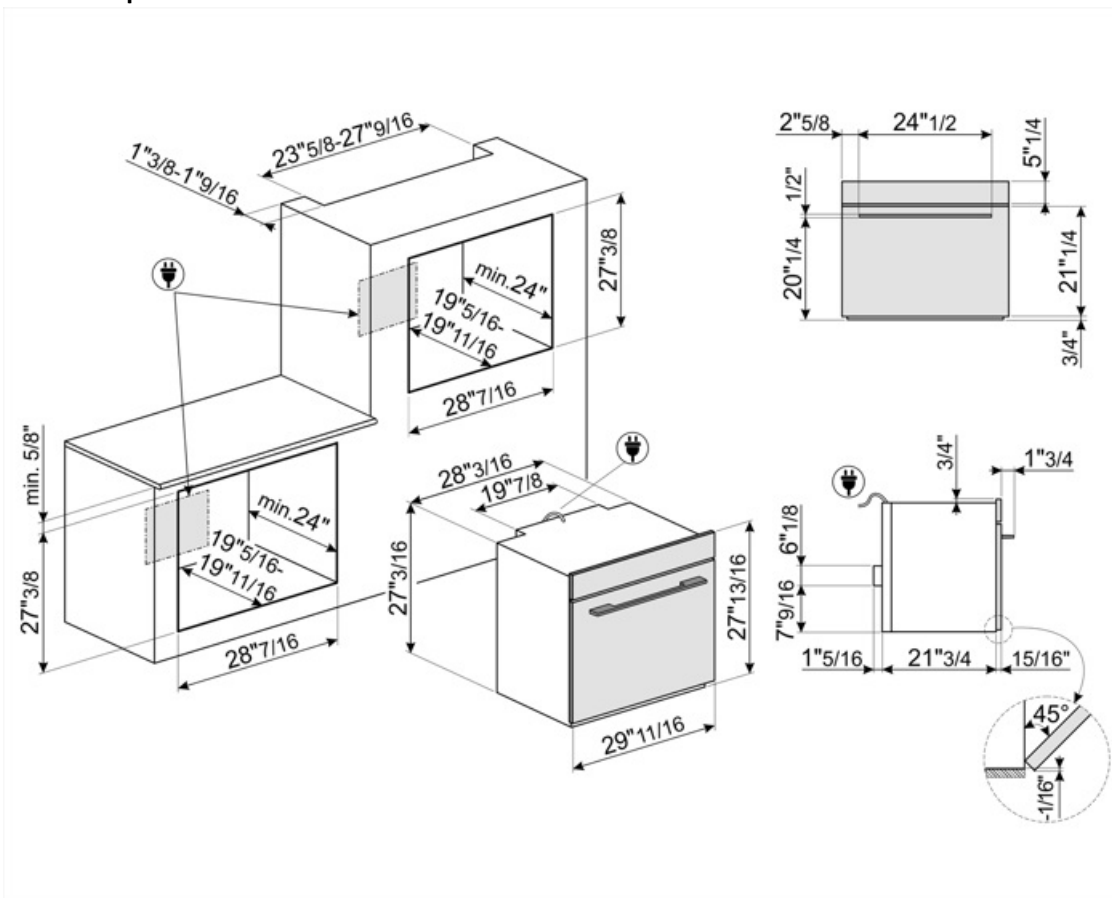

Compatible Accessories

ET50

Enamelled tray, 50mm deep































STONE

Rectangular refractory stone PPR2. Ideal for cooking pizzas with the same results as a typical wood-fired oven. Can also be used for baking bread, focaccias and other recipes such as pies, flans or biscuits Dimensions: L42 x H1,8 x P37,5 cm.



Symbols glossary

 <p>Child lock: some models are fitted with a device to lock the programme/cycle so it cannot be accidentally changed.</p>	 <p>Air cooling system: to ensure a safe surface temperatures.</p>
 <p>With the switch on this symbol, no heating is possible even if the thermostat is turned.</p>	 <p>Quadruple glazed: Number of glazed doors.</p>
 <p>Electric</p>	 <p>Circogas: In gas ovens the fan distributes the heat quickly and evenly throughout the oven cavity, avoiding flavour transfer when cooking a number of different dishes at the same time. In electric ovens this combination completes cooking more quickly of foods that are ready on the surface, but that require more cooking inside, without further browning.</p>
 <p>Fan with upper and lower elements: The elements combined with the fan aim to provide more uniform heat, a similar method to conventional cooking, so pre-heat is required. Most suitable for items requiring slow cooking methods.</p>	 <p>Upper and lower element only: a traditional cooking method best suited for single items located in the centre of the oven. the top pf the oven will always be hottest. Ideal for roast, fruit cakes, bread etc.</p>
 <p>Lower heating element only: This function is ideal for foods that require extra base temperature without browning, e.g. pastry dishes, pizza. Also suitable for slow cooking of stews and casseroles.</p>	 <p>Circulaire with lower element: The addition of the lower element adds extra heat at the base for food which requires extra cooking.</p>
 <p>True European Convection: The combination of the fan and circular heating element around it provides many benefits, including no preheat if cooking time is longer than 20 minutes, no flavor transfer when cooking different foods at the same time, lower energy consumption, and shorter cooking times. Suitable for all types of food preparations.</p>	 <p>Grill element: Using of grill gives excellent results when cooking meat of medium and small portions, especially when combined with a rotisserie (where possible). Also ideal for cooking sausages and bacon.</p>
 <p>Fan with grill element: The fan reduces the fierce heat from the grill, providing an excellent method of grilling various foods, chops, steaks, sausages etc. giving even browning and heat distribution, without drying out the food. The top two levels recommended for use, and the lower part of the oven can be used to keep items warm at the same time, an excellent facility when cooking a grilled breakfast. Half grill (centre portion only) is ideal for small quantities of food.</p>	 <p>Circulaire with upper and lower elements: The use of the fan with both elements allows food to be cooked quickly and effectively, ideal for large joints that require thorough cooking. It offers a similar result to rotisserie, moving the heat around the food, instead of moving the food itself, enabling any size or shape to be cooked.</p>
 <p>KEEP_WARM_72dpi</p>	 <p>Side lights: Two opposing side lights increase visibility inside the oven.</p>
 <p>Pyrolytic: Pyrolytic cleaning cycles can be selected as necessary to automatically clean the oven interior.</p>	 <p>Cooking with temperature probe: It is possible to display the temperature detected by the probe and set a target temperature that the dish must reach. When the core of the dish reaches the desired temperature, cooking stops</p>

-
- | | | | |
|---|--|---|--|
|  | Air at 40°C provides the perfect environment for proving yeast type dough mixes. Simply select the function and place dough in the cavity for allotted |  | Rapid preheat: The rapid preheat function can be used to reach the selected temperature in just a few minutes. |
|  | Sabbath: This function allows you to cook food during the Sabbath, the Holiday of rest in the Jewish religion, respecting the precepts. The oven works |  | The oven cavity has 6 different cooking levels. |
|  | Telescopic rails: allow you to pull out the dish and check it without having to remove it from the oven entirely. |  | Electronic control: Allows you to maintain temperature inside the oven with the precision 2-3 ° C. This enables to cook meals that are very sensitive to temperature changes, such as cakes, souffles, puddings. |
|  | Touch controls: Easy to use touch controls allow the appliance to be programmed at the touch of a button. |  | The capacity indicates the amount of usable space in the oven cavity in litres. |
|  | The capacity indicates the amount of usable space in the oven cavity in litres. |  | ... |
|  | ... | | |