

# ASSEMBLY GUIDE

## PACKAGE CONTENTS

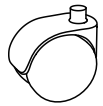

5x Wheels

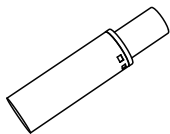

1x Gas Rod

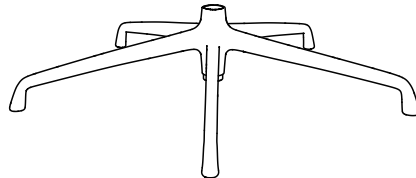

1x Metal Leg

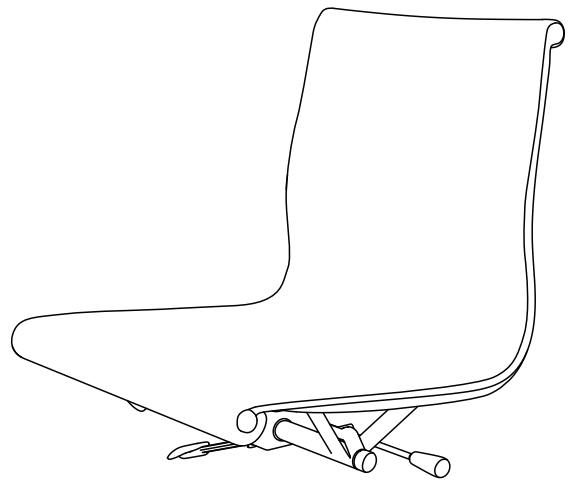

1x Seat

**1** Insert the wheels into the base.

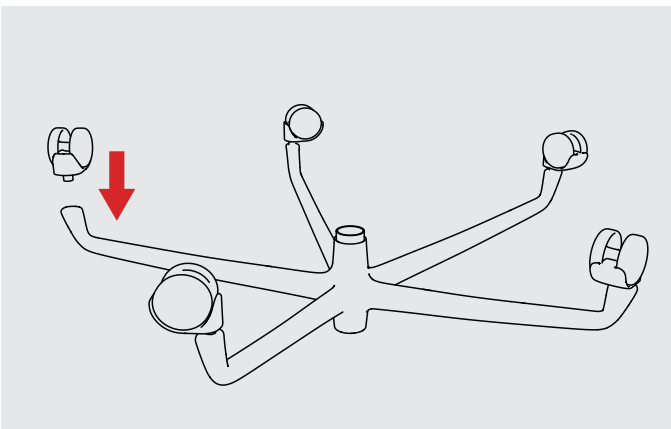

**2** Buckle the bottom of the gas rod into the base.

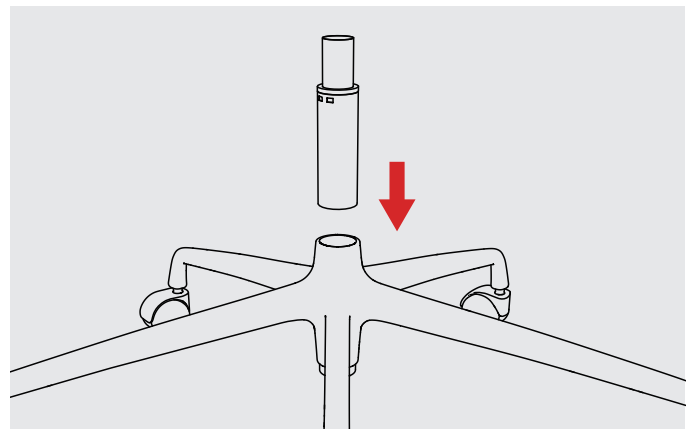

**3** Align the installed seat into the air pressure bar.

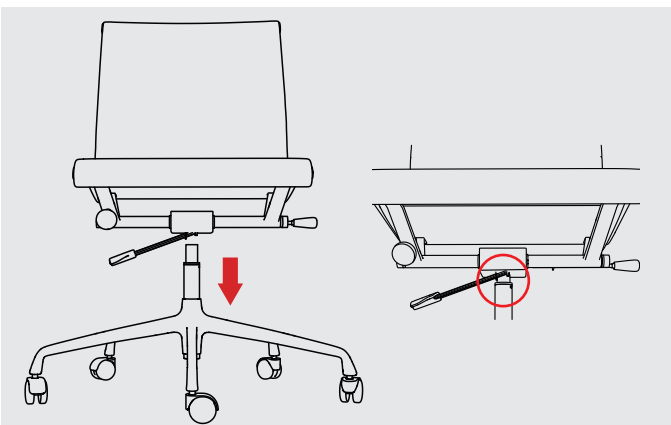

**4** A. Seat height adjuster.  
B. Seat tifting tension adjustor. Loose/Locking

