

Wood Slat Acoustic Panel

PP-WS4X8
Assembly Manual



Better Products for a Better Workspace Experience

We are dedicated to creating high-end ergonomic solutions
for the office with top of the industry support.

Explore Endless Workspace Solutions

www.vivo-us.com



WARNING



If you do not understand these directions, or if you have any doubts about the safety of the installation, please contact our product support team at 309-278-5303 or help@vivo-us.com for further assistance. Check carefully to make sure there are no missing or defective parts. Failure to report missing parts within 30 days may result in denial of free replacement. Improper installation may cause damage or serious injury. Do not use this product for any purpose that is not explicitly specified in this manual. Do not exceed weight capacity. We cannot be liable for damage or injury caused by improper mounting, incorrect assembly or inappropriate use.



NOT INTENDED FOR ROUGH SURFACES

Product is designed for smooth surfaces ONLY and SHOULD NEVER BE APPLIED TO brick, concrete, block, diamond plate surfaces, textured appliances, coarse coated beams, or other rough wall surfaces.



WARNING: DO NOT INSTALL ONTO DRYWALL ALONE

VERIFY YOUR WALL CONSTRUCTION. INSTALL HARDWARE INTO A WOOD BACKING. If unsure, please contact us at vivo-us.com, email at help@vivo-us.com, or call us at 309-278-5303.

Package Contents

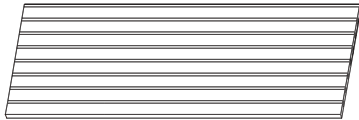

A (x8)
Acoustic Panel

Tools Needed:



**Phillips
Screwdriver**



Drill

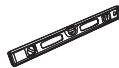

Level



Saw

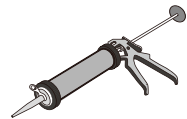

Adhesive



Tape Measure



Assembly Video & Product Info
www.vivo-us.com/products/pp-ws4x8

Assembly Steps

STEP 1

Clean the wall where you plan to secure the Acoustic Panels (**A**).

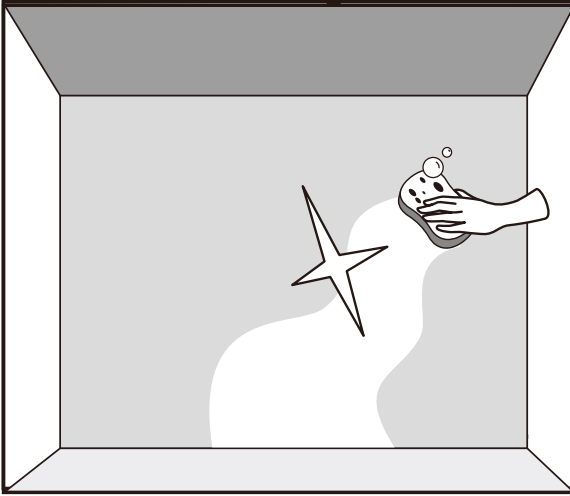

Use a tape measure to measure the width and height of the wall and cut the Acoustic Panels (**A**) to the desired size using a circular saw or a hand saw.

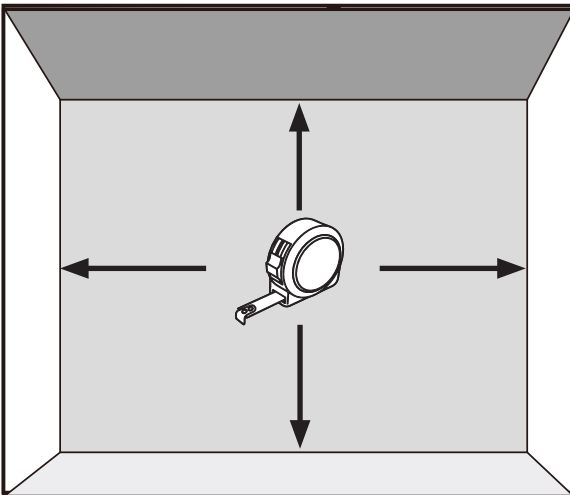

STEP 2

Option 1: Attach with Adhesive

Apply appropriate adhesive evenly to the back of Acoustic Panels (**A**).

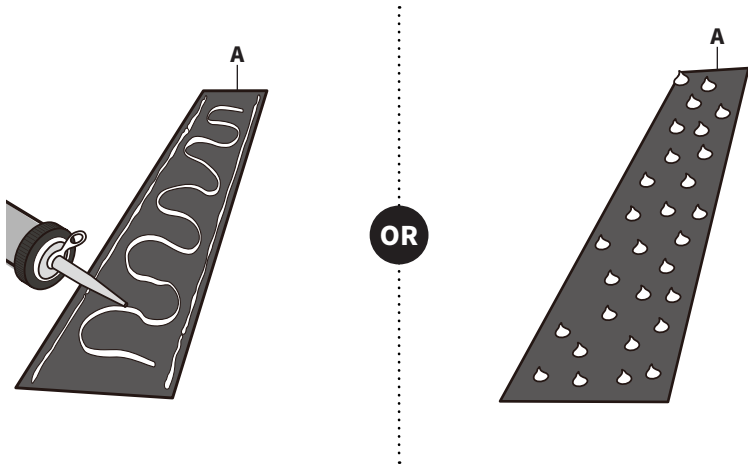

Paste the Acoustic Panels (**A**) to the wall, using a level to ensure they are even.

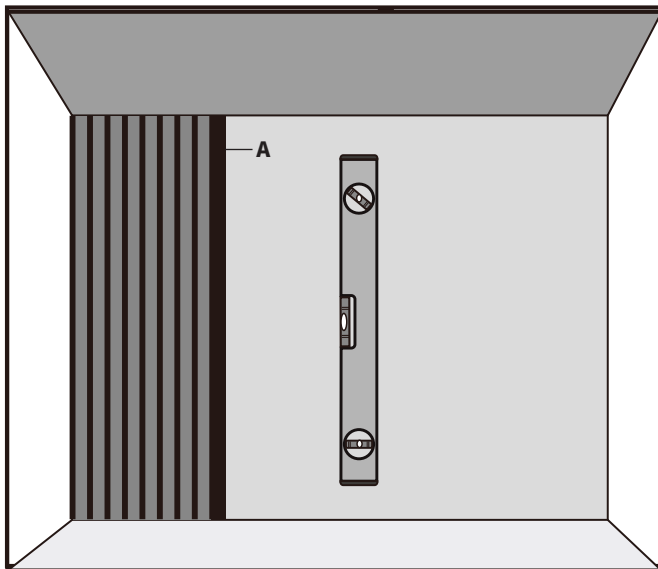

Assembly Complete

Option 2: Attach with Hardware

Hold the Acoustic Panels (A) up to the wall where desired and attach them using screws or nails (not included) between the wood slats. Use of a level is recommended.

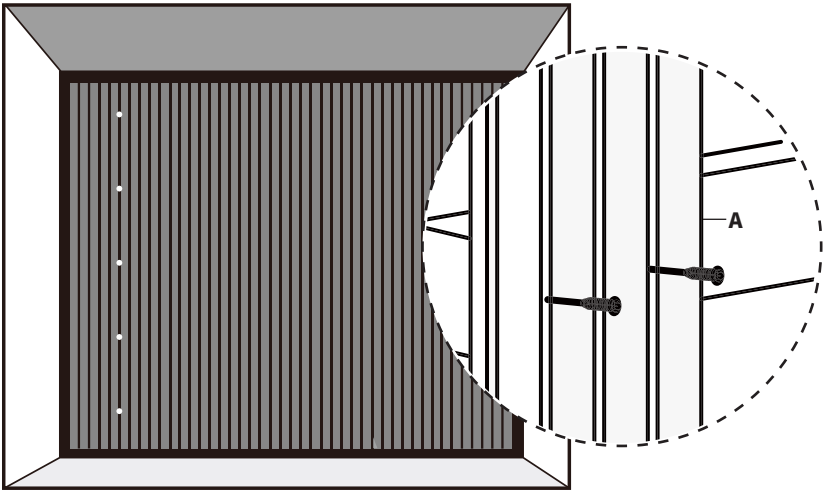

WARNING: DO NOT INSTALL ONTO DRYWALL ALONE

VERIFY YOUR WALL CONSTRUCTION. INSTALL HARDWARE INTO A WOOD BACKING. If unsure, please contact us at vivo-us.com, email at help@vivo-us.com, or call us at 309-278-5303.

Please Note

Each Acoustic Panel (A) should be attached to at least three wood locations. If installing horizontally, the Panels can be installed directly to the wood studs.

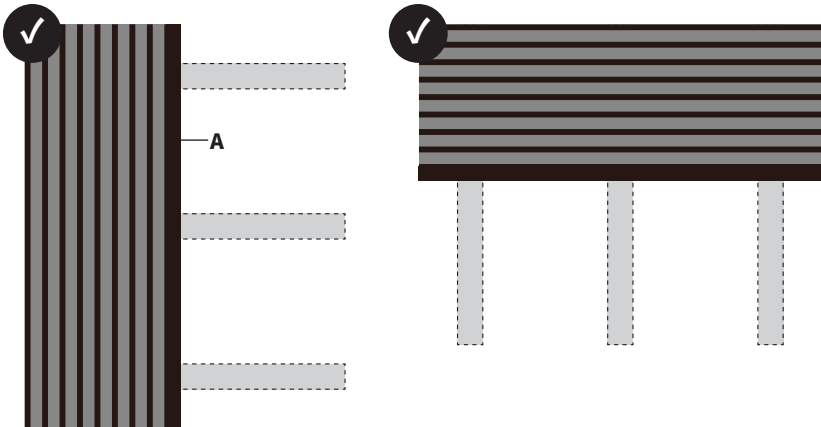

V·I·V·



Love Your New Setup?
Tag Us on Social!



@VIVO-us



@vivo_us



@VIVOus



VIVO



Need Help? **We're Here For You**

Monday-Friday from 7am-7pm CST

Saturday 8am-4pm CST



Email Us
help@vivo-us.com



Chat with Live Agent
www.vivo-us.com



Give Us a Call
309-278-5303 ext. 1



VIVO-us



@vivo_us



@VIVOus



VIVO