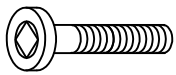
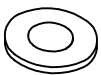
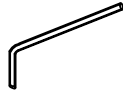

ASSEMBLY INSTRUCTIONS

MODEL : #1501DS-110 (V#12600CF SB1)

**NOTE : THIS ITEM NOT RECOMMENDED FOR COMMERCIAL USE
KEEP THIS DOCUMENT FOR REFERENCE IN CASE PARTS ARE NEEDED**

DO NOT TIGHTEN SCREWS UNTIL COMPLETELY ASSEMBLED !!

HARDWARE LIST				
NO		DESCRIPTION		QTY
1		BOLT	M6X50 mm	8PCS
2		Flat Washer	M6	8PCS
3		Wrench	M4	1PC

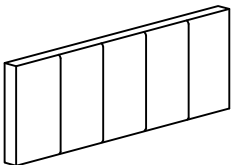
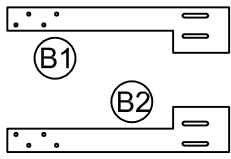
PART LIST			
NO		DESCRIPTION	QTY
A		HEADBOARD	1PC
B		WOODEN LEGS	2PCS

ASSEMBLY INSTRUCTIONS

MODEL : #1501DS-110 (V#12600CF SB1)

STEP 1 :

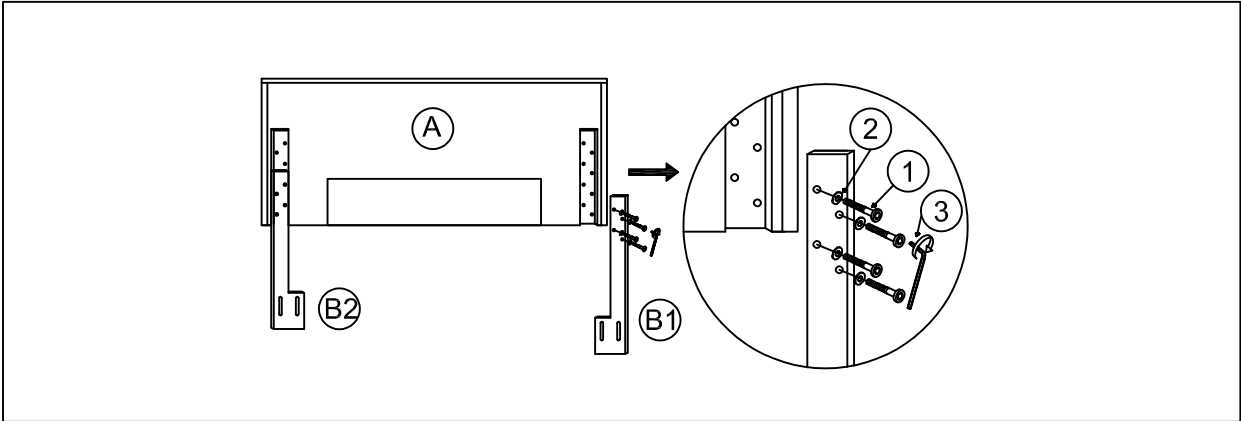

STEP 2 :

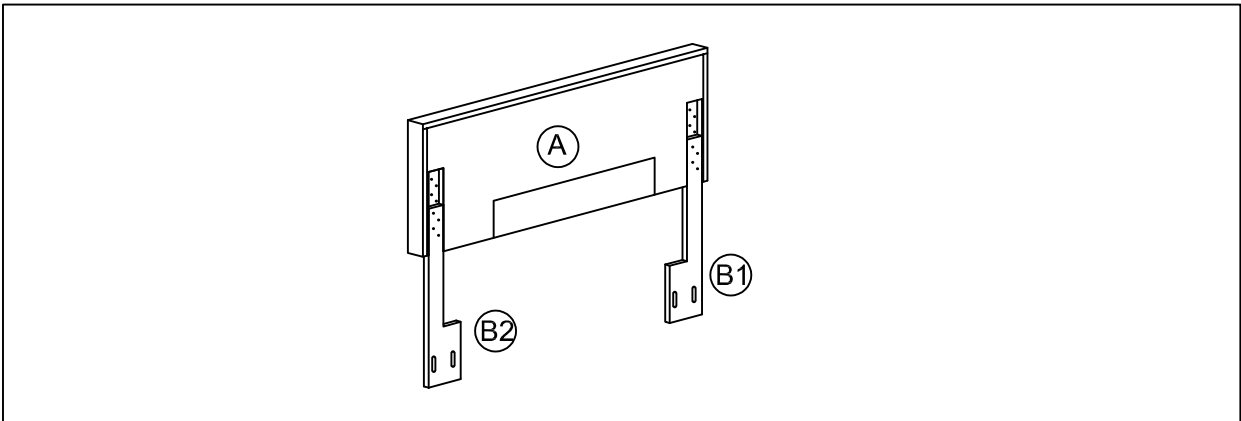

STEP 3 :

