



STOP

We just wanted to thank you for allowing New Ridge Home to be a part of your home. If you love what you received, please take the time to write a review on the site you purchased from.

WAIT

If there is any issue with your purchase, please contact us using the information found below. In many cases we have a part or hardware that will fix the issue without the hassle of having to return the item. To make a parts request, please note the following in your e-mail:

SKU number on the box (starting with NR)

The part number or letter of the part on the instruction sheet

A brief description of the issue

Your name & address

If possible, please also include a picture of the issue or the product.

Send request to: kcovey@newridgehomegoods.com

HOLD ON

Don't forget to check out our website www.newridgehomegoods.com where you will find our complete line of products, assembly instructions, and more.

From our entire team, Thank You for your business, we truly appreciate it!

ASSEMBLY INSTRUCTIONS



SWIVEL BARSTOOL







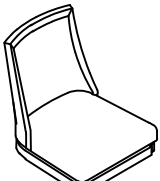
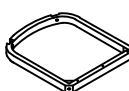
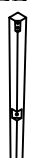

Do not fully tighten all screws until assembly is complete.

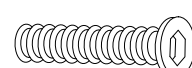
NR1101PB-01AW

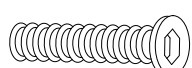
NR1101PC-02AW

A SEAT  1 PC	B STRETCHER  1 PC	C FRONT LEFT LEG  1 PC	D FRONT RIGHT LEG  1 PC	E BACK LEG  2 PC
--	---	--	---	--

1 LONG BOLT Ø5/16" x 60mm  10 PC	2 SPRING WASHER Ø5/16" x 10 x 1.5mm  10 PC	3 FLAT WASHER Ø5/16" x 10 x 1.5mm  10 PC	4 SHORT BOLT Ø1/4" x 38mm  2 PC
---	---	--	--

5 SPRING WASHER Ø1/4" x 10 x 1.5mm  2 PC	6 FLAT WASHER Ø1/4" x 10 x 1.5mm  2 PC	7 ALLEN KEY 2-1/4" x 4mm  1 PC
---	---	--

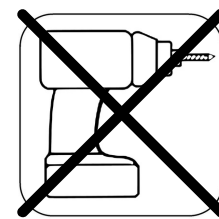
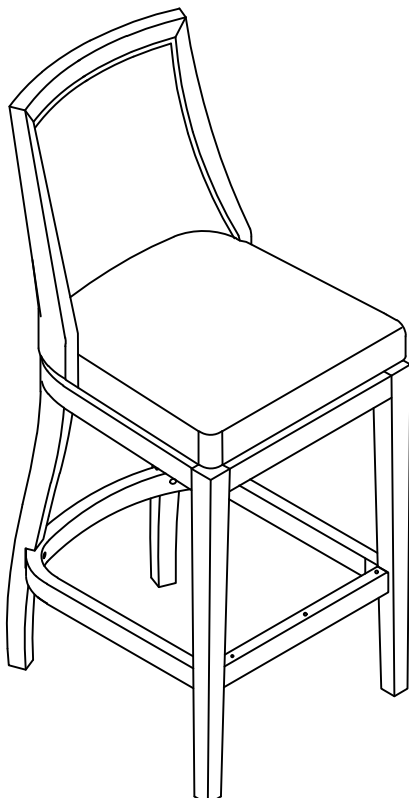

**No drills necessary.
Do not use power
screwdriver.**

This page lists all the contents included in the box. Please take the time to identify the hardware as well as the individual components to this product. As you unpack and prepare for assembly, place the contents on a carpeted or padded area to protect them from damage.

STEP 1 Insert stretcher (B) into the joint of legs.
 Make sure the metal foot rest on the stretcher is facing towards the seat and is pointing towards the front of the stool.

Attach front left leg (C) and front right leg (D) to the stretcher (B) with the long bolts (1), spring washers (2), and flat washers (3) using Allen key (7).
 Do not fully tighten the bolts.

Attach back legs (E) to the stretcher (B) with the short bolts (4), spring washers (5), and flat washers (6) using Allen key (7).
 Do not fully tighten the bolts.

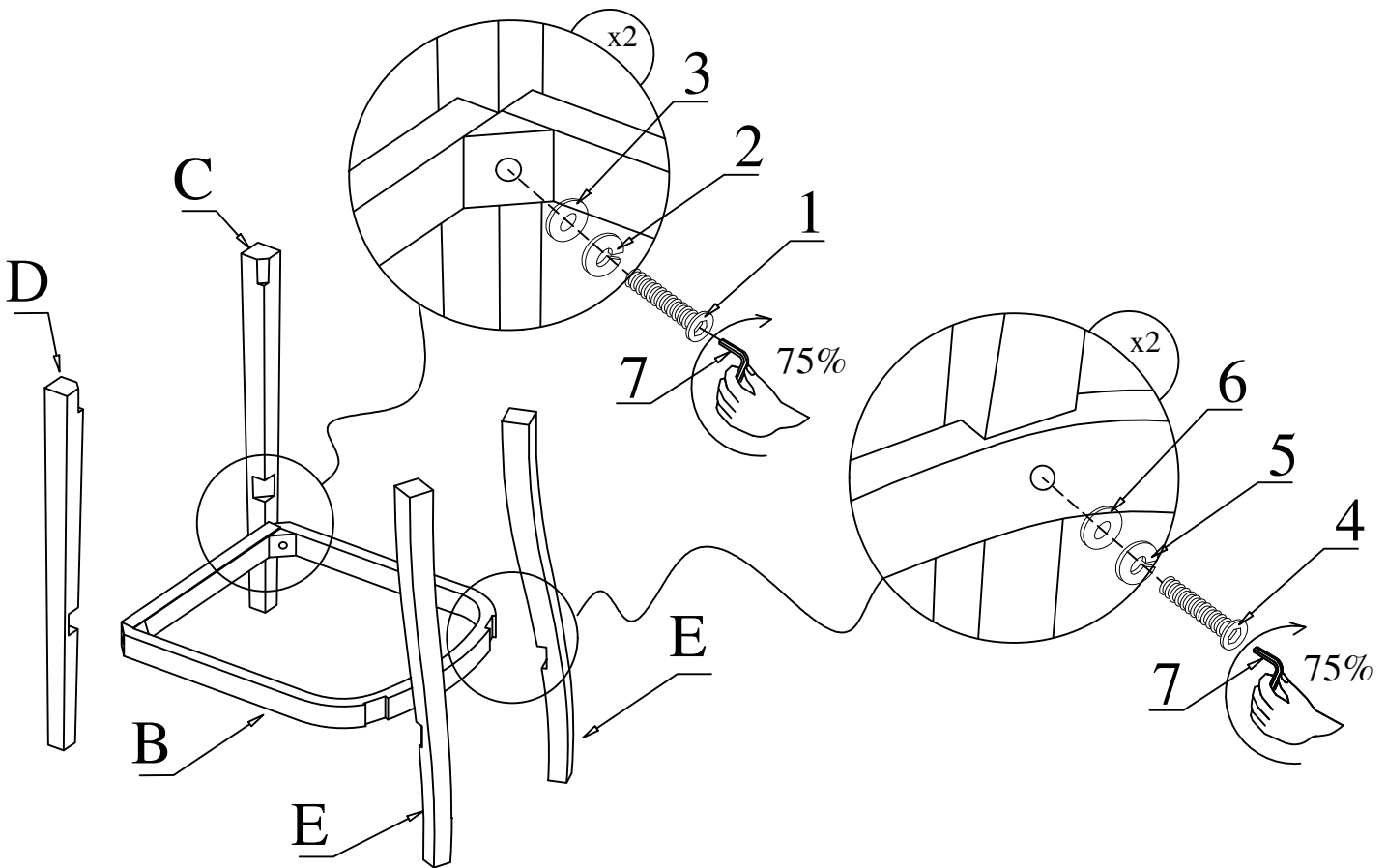

STEP 2 Attach the legs to the seat with the long bolts (1), spring washers (2), and flat washers (3) using Allen key (7). Do not fully tighten the bolts.

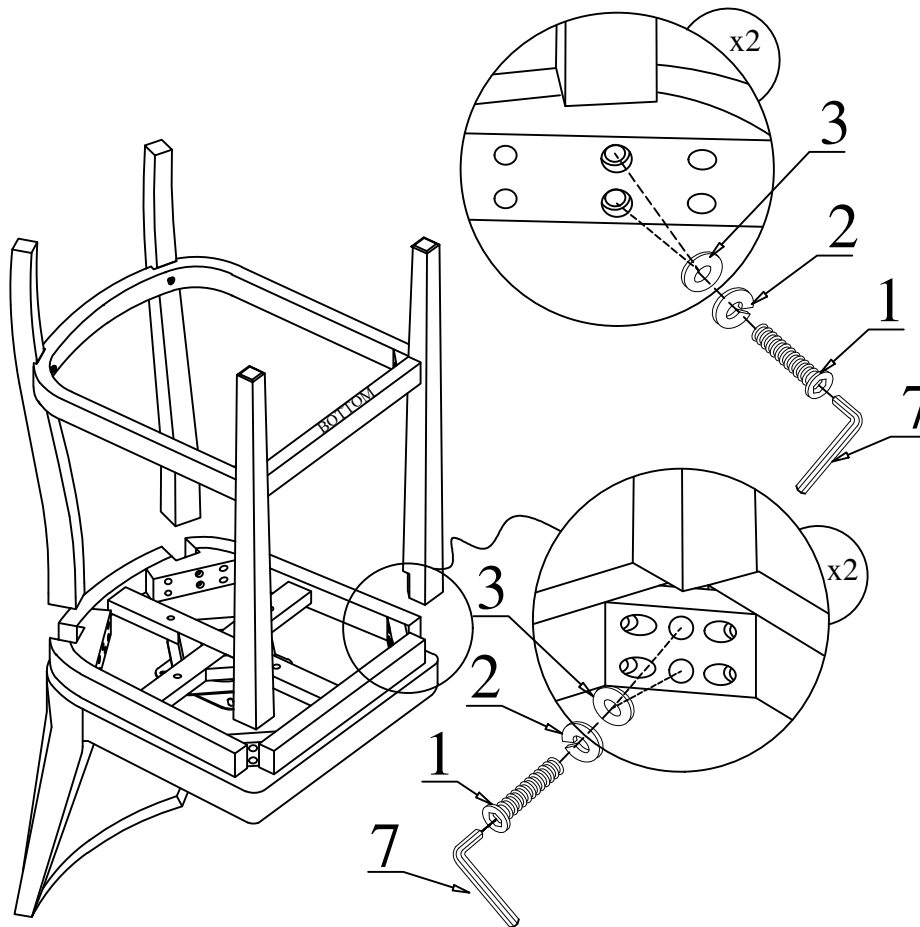

STEP 3 Turn stool upright and place on flat surface. Ensure the legs are aligned and seat is level, then fully tighten all bolts from Steps 1 and 2.

COMPLETE

