

Assembly Instructions

Hanging Chair





⚠ WARNING:





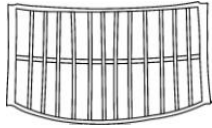
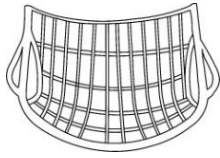

Thank you for purchasing the Hanging Chair. Please read below before you proceed.

- 1. Not intended for use by children 12 years of age or younger.**
- 2. This is a hanging chair, not a swing chair.**
- 3. The hanging chair should be installed no more than 20" above ground.**
- 4. The hanging chair should be installed at a minimum of 4-5 feet away from the walls.**
- 5. The hanging chair should have a minimum clearance of 30" from any obstacles.**
- 6. Do not swing on or in the chair. It could cause the product to tip over, resulting in possible injury.**
- 7. This chair basket is not a toy.**
- 8. No mounting hardware kit included.**
- 9. Professional installation required.**

Parts List

No.	Picture	Description	Qty
A		Top	1
B		Back	1
C		Seat	1
D		Cushion	1
E		8ft Chain	1

Hardware

①		Allen key	1
②		Bolt (M6*40mm)	7
③		Washer	14
④		Nut	7
⑤		Wrench	1
⑥		Nut Cap	7
⑦		Nut Cap	7

Assembly Steps



• Read the instructions before you start the assembly.



• May need assistance for assembly.



• Assemble on a clean and smooth surface.



• Save all package until finished.

Overview

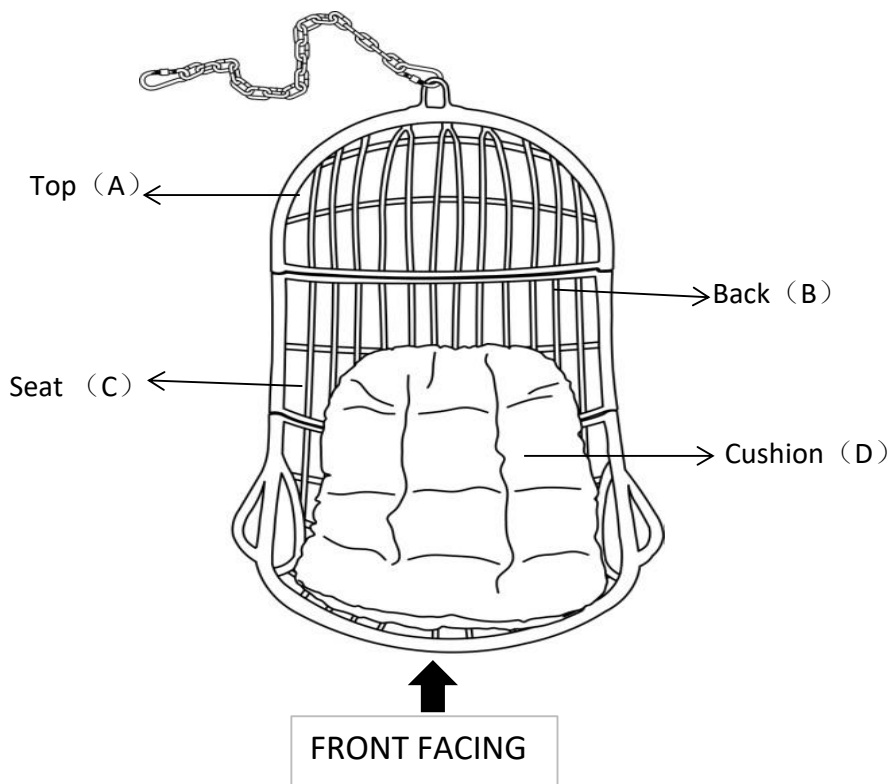

This Basket has multiple parts and may require up to 30 minutes to assemble. The above picture is to help you put the various parts into perspective. Please read through the instructions below to familiarize yourself with the parts and steps before assembly.

Step 1

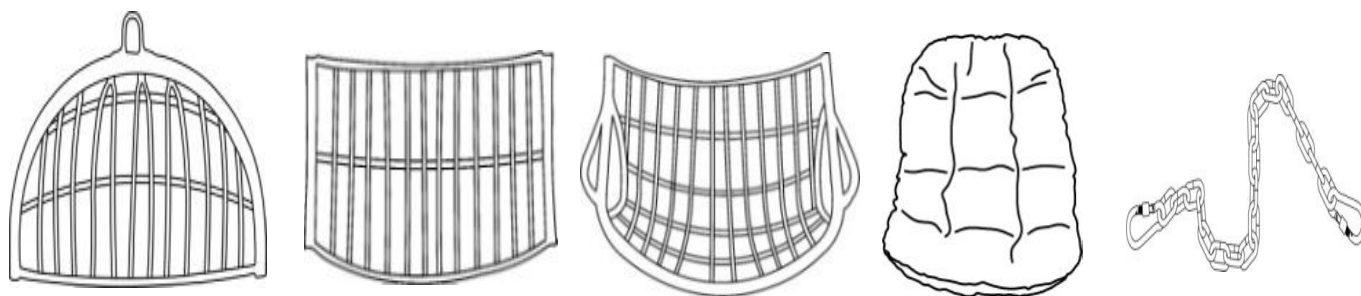

Unpack and place all parts on a clean surface.

Step 2

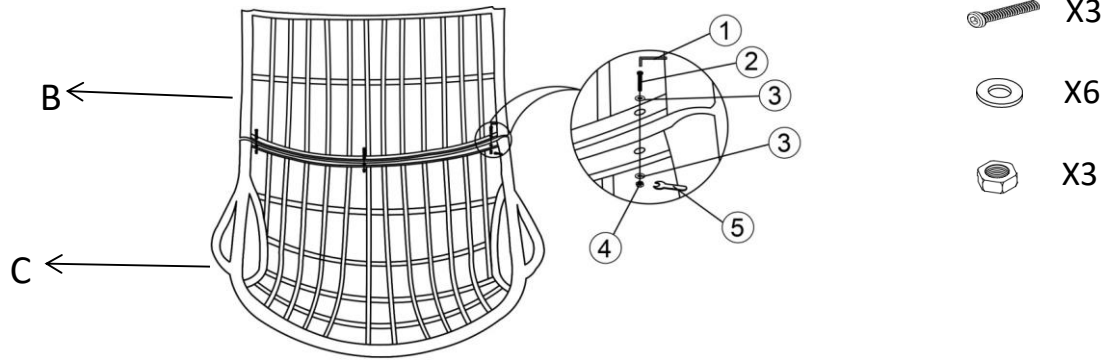

Assemble Back (B) and Seat (C) by using Bolt (②), Nut (④) and Washer (③) with Allen Key (①) and Wrench (⑤). Do not tighten.

Step 3

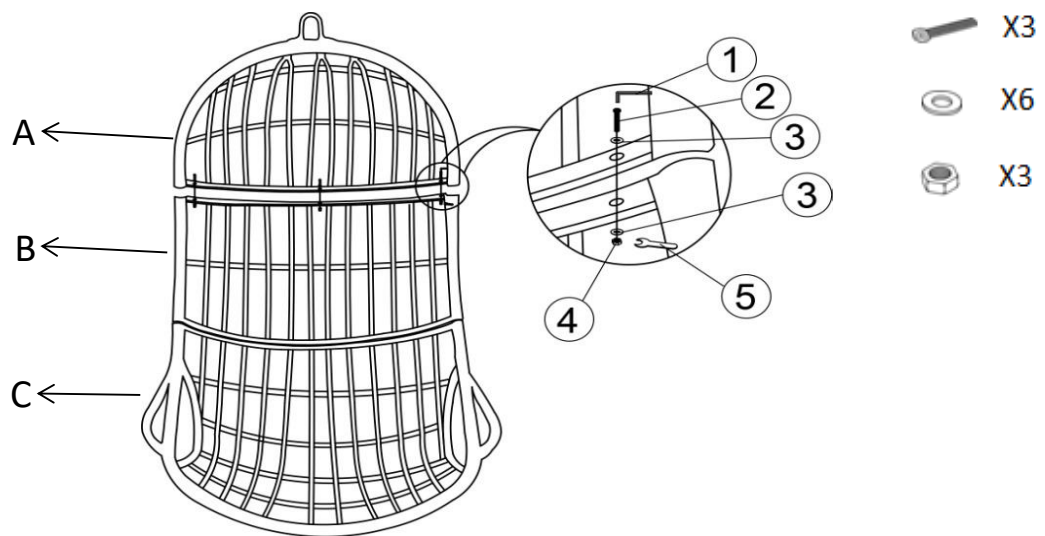

Proceed to assemble Top (A) and Back (B) by using Bolt (②), Nut (④) and Washer (③) with Allen Key (①) and Wrench (⑤). Do not tighten.

Step 4

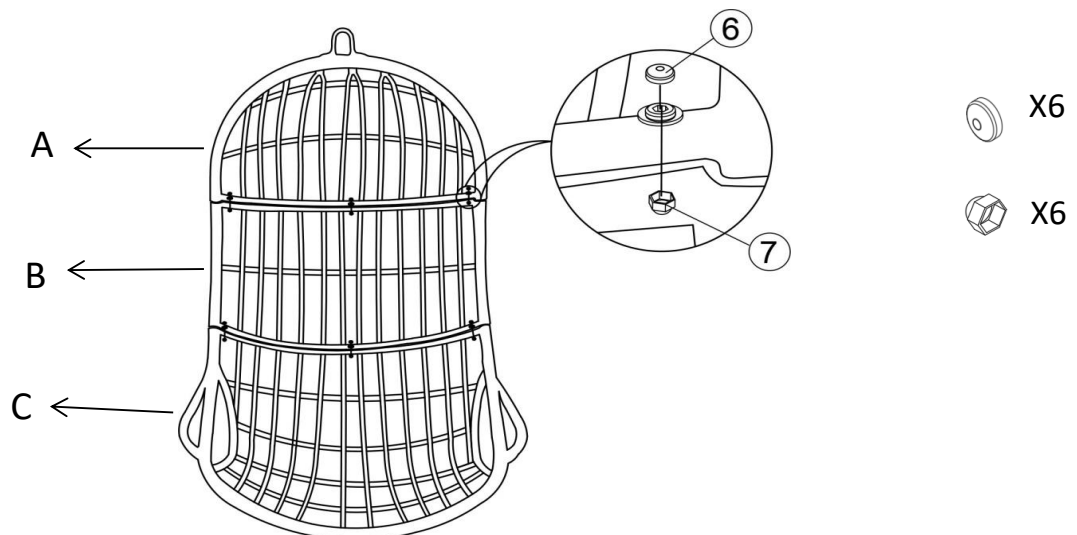

Tighten all screws and nuts . Then add the Nut Caps(⑥, ⑦) on the 6 Bolts as shown in the picture above.

Step 5

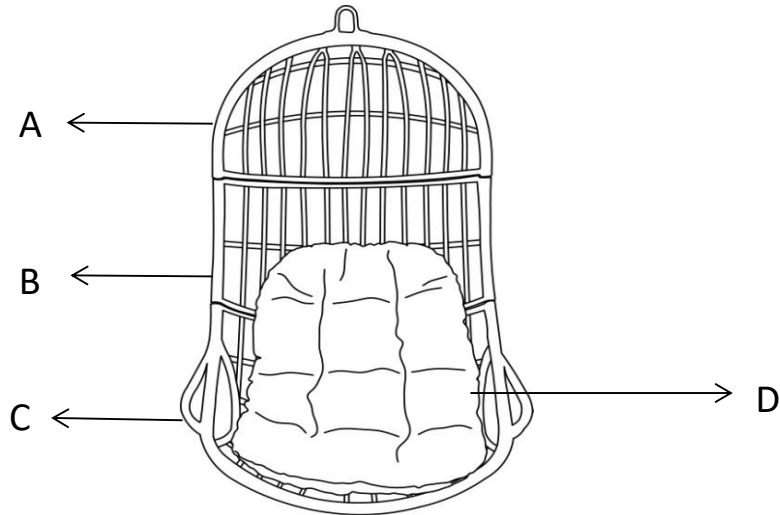





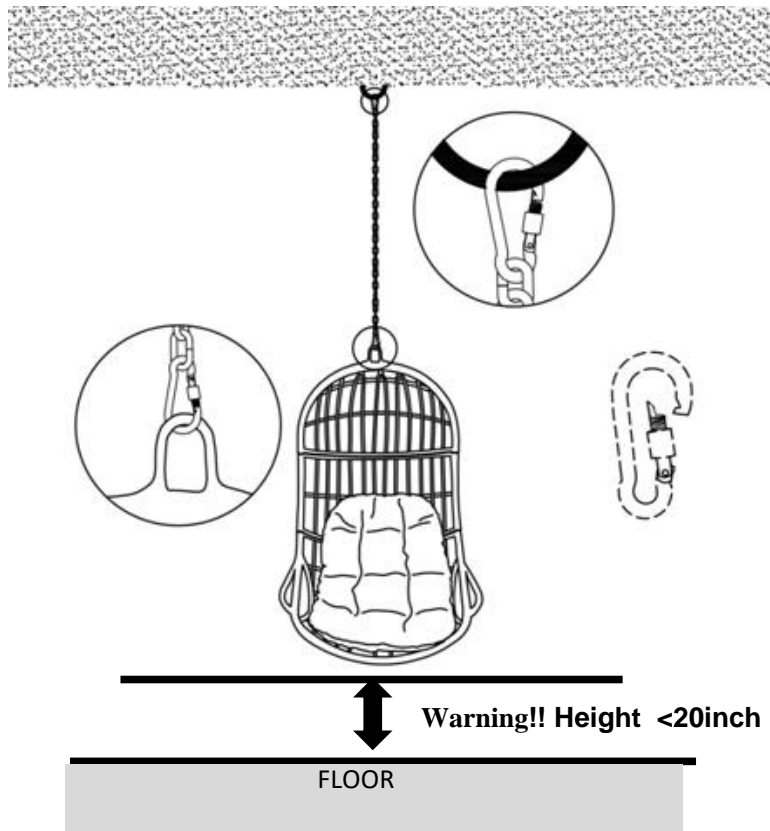





Place the Cushion(D) on the Basket.

Step 6



Install 8ft chain to the basket, than hang the basket on the ceiling, your hanging chair is ready for use.

Care & Maintenance

- ⊘  ● Prolonged exposure to rain may cause rusting which can stain floors.
- ⊘  ● Do not put hot items directly on furniture surface.
- ⊘  ● Do not clean furniture with harsh cleansers or polish.
- ✓  ● To obtain the longest lifespan of your outdoor products, minimizing exposure to direct sunlight is recommended.
- ⊘  ● Children should not climb or jump on the furniture.
- ✓  ● To obtain the longest lifespan of your outdoor products, avoid extended and lengthy exposure to rain, snow, and direct sunshine. Whenever possible cover the product and /or place under patio or awnings.
- ⊘  ● Not for commercial use. For residential use only.
- ⊘  ● Stains may be removed with mild soap solution and damp cloth.
- ✓  ● Keep away from sources of ignition
- ✓  ● Dust and Pick-up spills: Use a Clean, non-colored, lint free cloth.