

ASSEMBLY INSTRUCTION

N723P186139

N723P186141

N723P186144

Friendly Reminder:

- 1.This sofa is packed in 3 boxes. Please assemble it After all boxes are received.
- 2.As the cushions are all vacuum compressed,there will be some wrinkles. Please give your cushions up to 72 hours to reach its original size and the wrinkles will basically disappear.
- 3.Please do not open the compressed packages until your sofa frame is completely assembled.

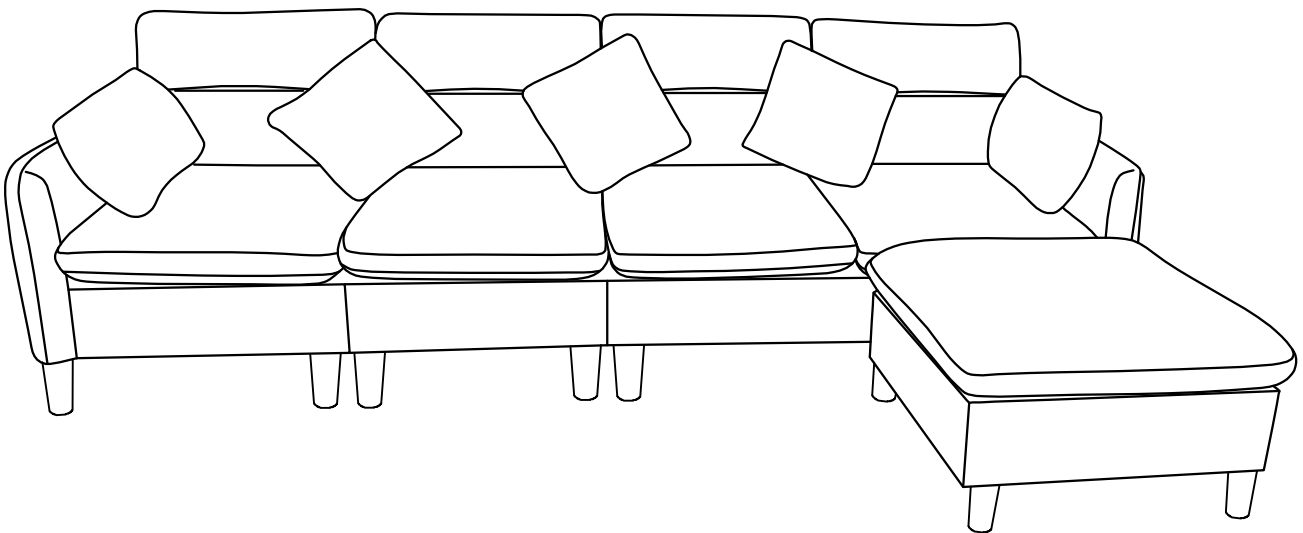





Return & Warranty policy:



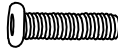
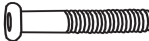

- We strive to offer the highest quality products,and we also try our best to satisfy each and every customer that orders from us with replacement parts or service as needed.
- If the item is damaged or defective, please take photos as evidence for replacements and refunds.
- Please do not return to store,contact the seller if you have any troubles with this product.

ASSEMBLY INSTRUCTION

HARDWARE N723P186139

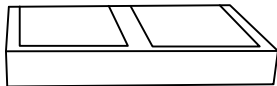

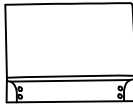
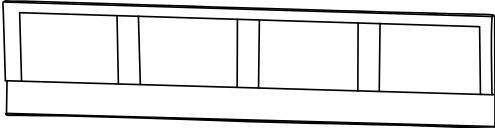

NO	DESCRIPTION	SKETCH	QTY
1	Gasket		16
2	Washer		32
3	Screws 8X60		24
4	Screws 8X80		4
5	Butterfly nut		4
6	Wrench		1

PARTS LIST N723P186139

NO	DESCRIPTION	SKETCH	QTY
B	Chaise frame		1
E	Seat cushion		1
H	Back cushion		2
F	Back frame		4
G	Back cover		1
O	Leg		4



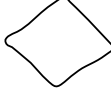



ASSEMBLY INSTRUCTION

PARTS LIST N723P186141

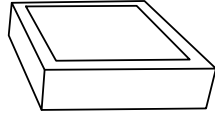
NO	DESCRIPTION	SKETCH	QTY
A	Seat frame		2
E	Seat cushion		2
H	Back cushion		2
I	Pillow		3
J	Armrest cushion		2
O	Leg		8

ASSEMBLY INSTRUCTION

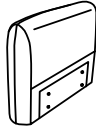



PARTS LIST N723P186144

NO	DESCRIPTION	SKETCH	QTY
P	Ottoman frame		1
K	Ottoman cushion		1
E	Seat cushion		1
O	Leg		4
C	Left armrest		1
D	Right armrest		1

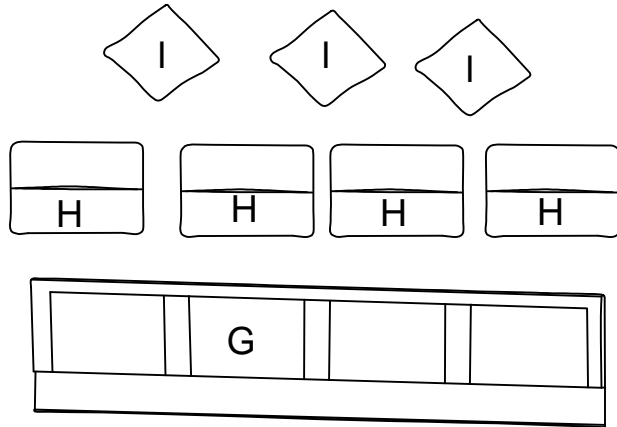
ASSEMBLY INSTRUCTION

All parts and hardwares.

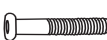

1		Gasket	16
2		Washer	32
3		Screws 8X60	24
4		Screws 8X80	4
5		Butterfly nut	4
6		Wrench	1

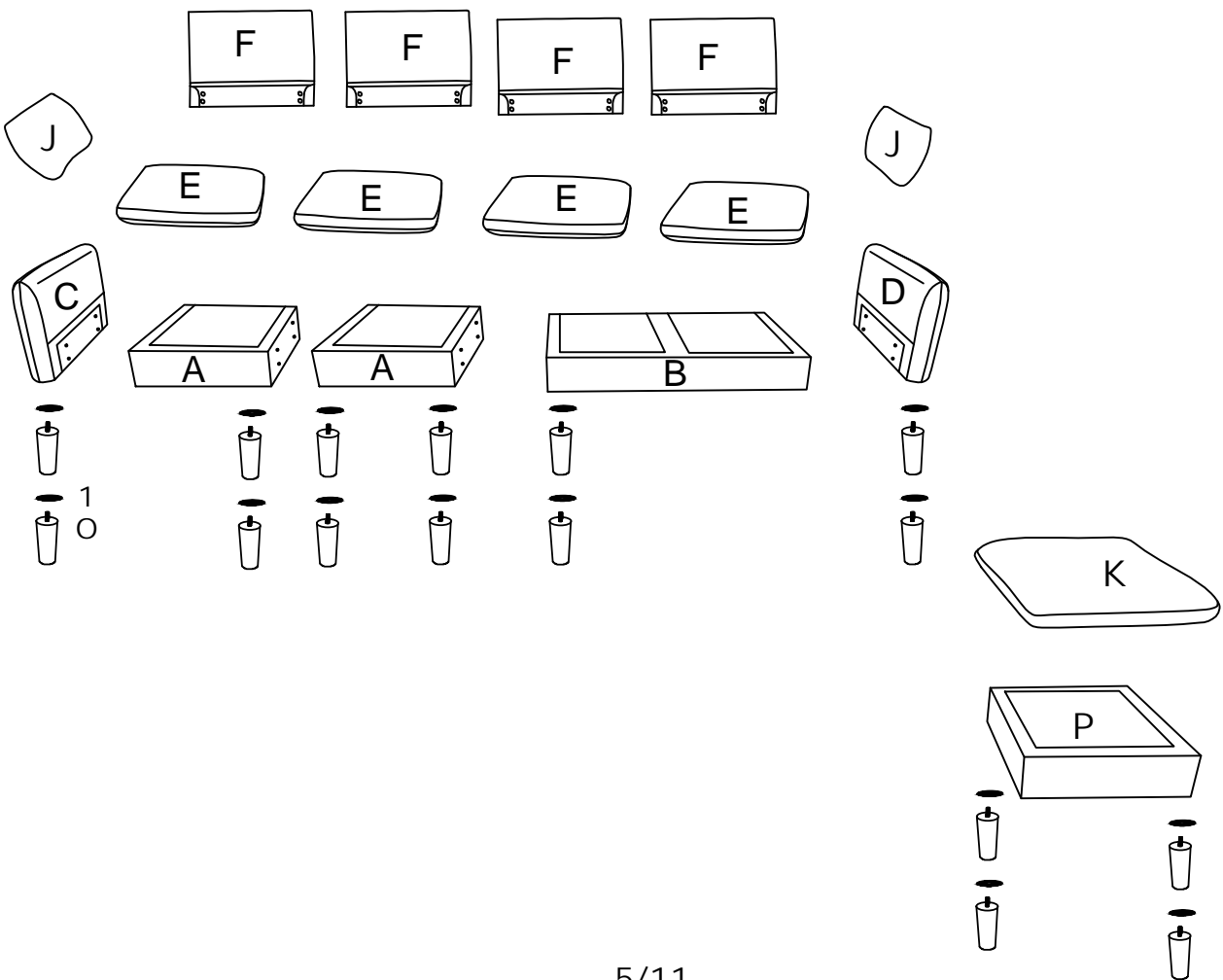



DIAGRAM 1 (Assemble the legs)

1		16PCS
O		16PCS

Assemble the Legs (Part O) on the Seat frames (Part A) , Chaise frame (Part B) , Ottoman frame (Part P) , Left armrest (Part C) , Right armrest (Part D) with the Gaskets (Hardware 1) .

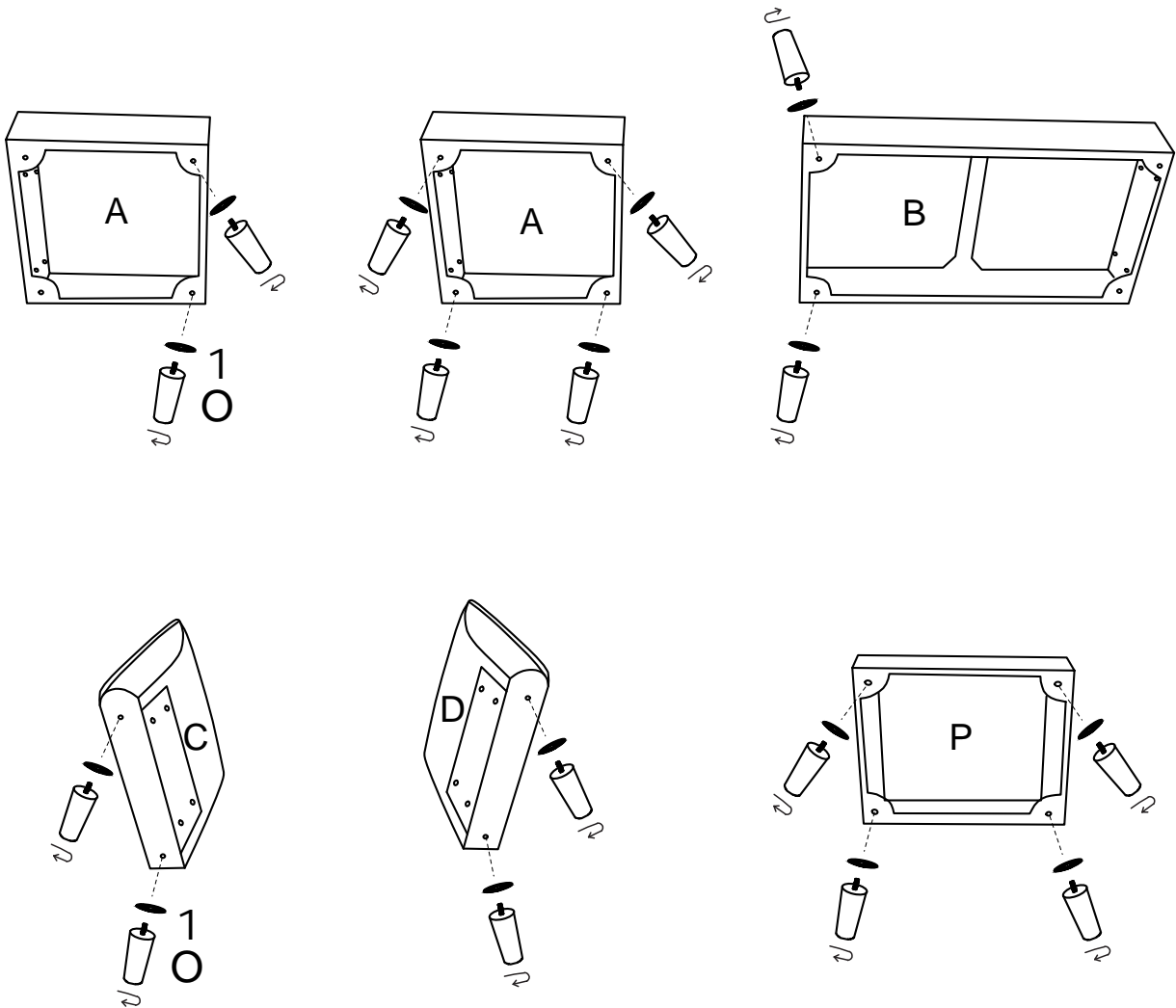

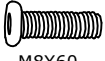

DIAGRAM 2 (Assemble the Armrests)

2		8PCS
3	 M8X60	8PCS

Assemble the Seat frame (Part A) and Left armrest (Part C) , Chaise frame (Part B) and Right armrest (Part D) with Washers (Hardware 2) and Screws (Hardware 3) by Wrench (Hardware 6).

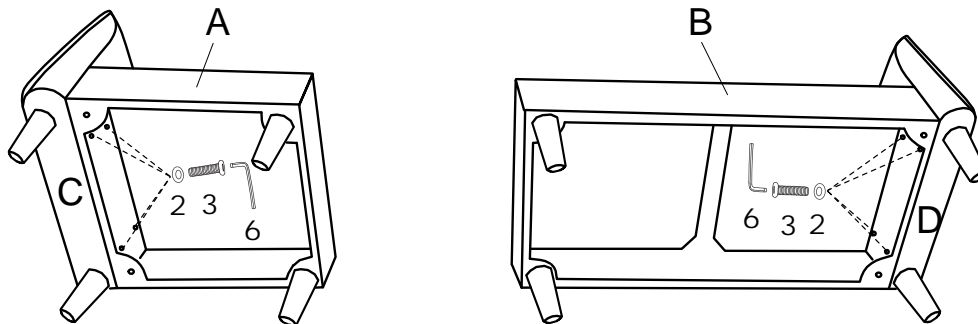





DIAGRAM 3 (Assemble the Seat frames)

2		8PCS
4	 M8X80	4PCS
5		4PCS
6		1PC

Assemble the Seat frames (Part A) and Chaise frame (Part B) with Washers (Hardware 2), Screws (Hardware 4) and Butterfly nuts (Hardware 5) by Wrench (Hardware 6).

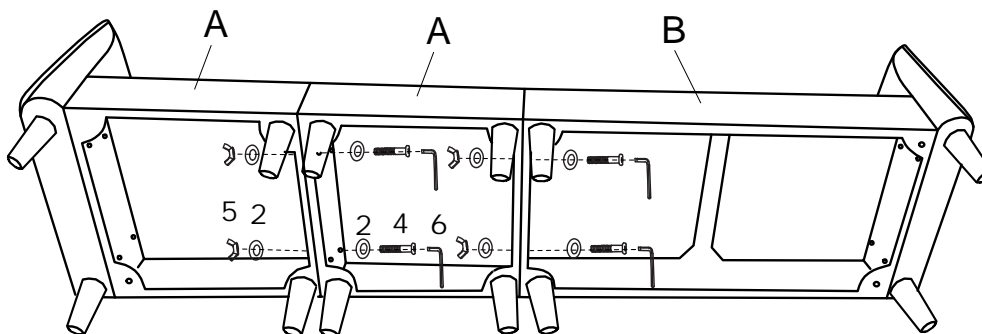



DIAGRAM 4 (Assemble the Back frames)

2		16PCS
3	 M8X60	16PCS

Place the washers (Hardware 2) and screws (Hardware 3) into the designated holes on the backrest, turn them to 70% by the wrench, and tighten all screws after it is fully installed.

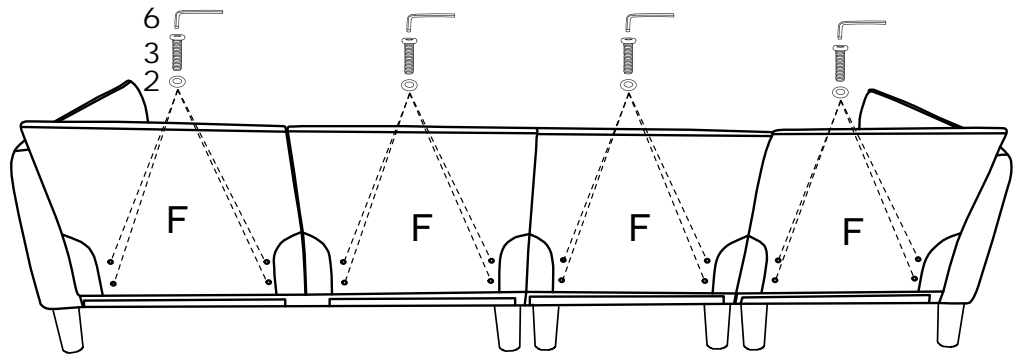

DIAGRAM 5 (Put the Back cover on the Back frame)

Place the Back cover (Part G) on the Back frame.



DIAGRAM 6 (Removal of compression bags)

Remove the Seat cushions (Part E), Back cushions (Part H), Pillows (Part I), Armrest cushions (Part J) and Ottoman cushion (Part K).

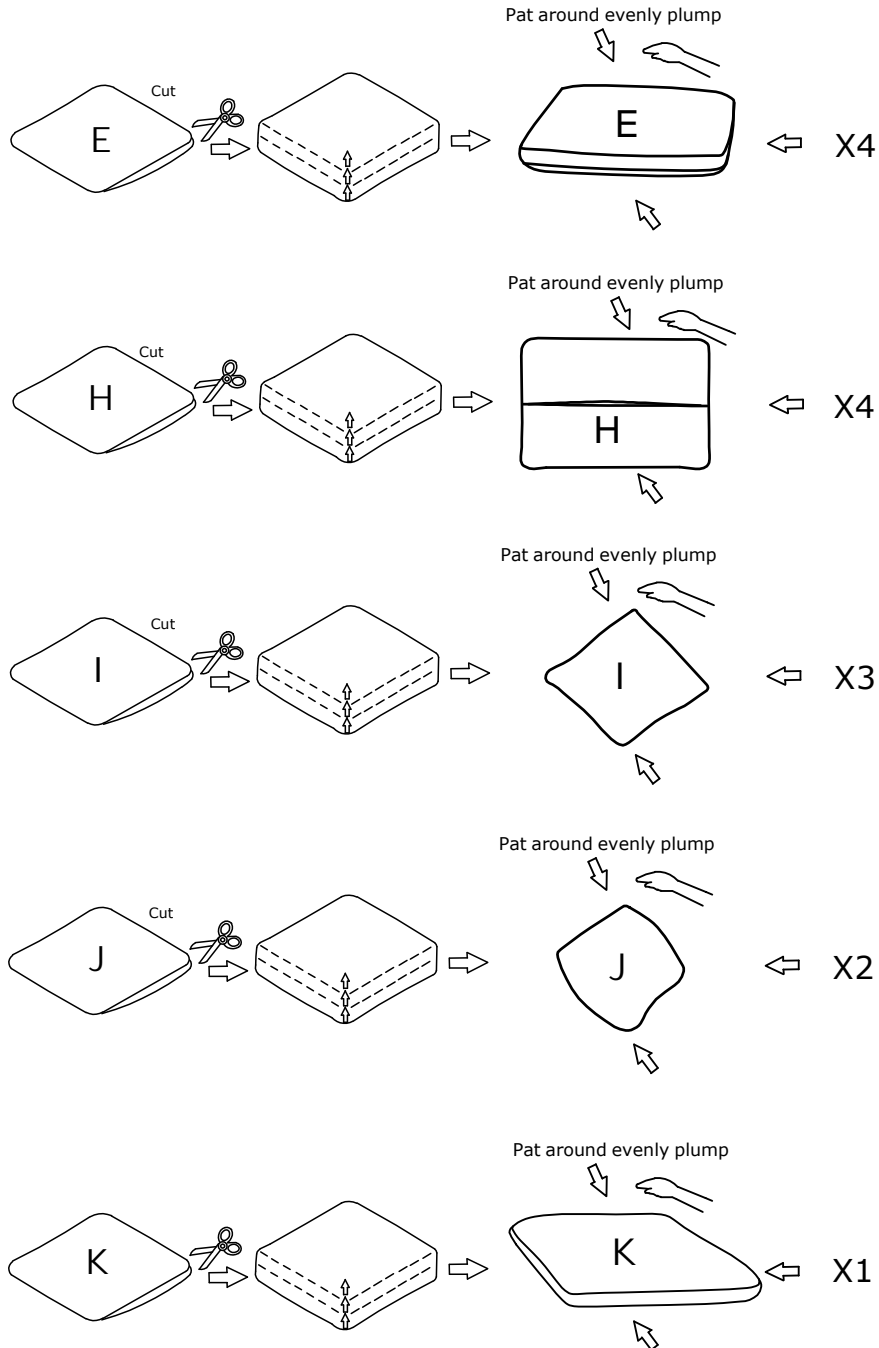

TIPS

1. Please do not open the compressed packages until your sofa frame is completely assembled.
2. Compressed back cushions and pillows need to be fully fulfilled within 72 hours for your perfect use.
3. Please keep children away from plastic bags or any small pieces of stuff.

DIAGRAM 7 (Place the Cushions on the sofa)

Place the Seat cushions (Part E), Back cushions (Part H), Pillows (Part I), Armrest cushions (Part J) on the sofa.

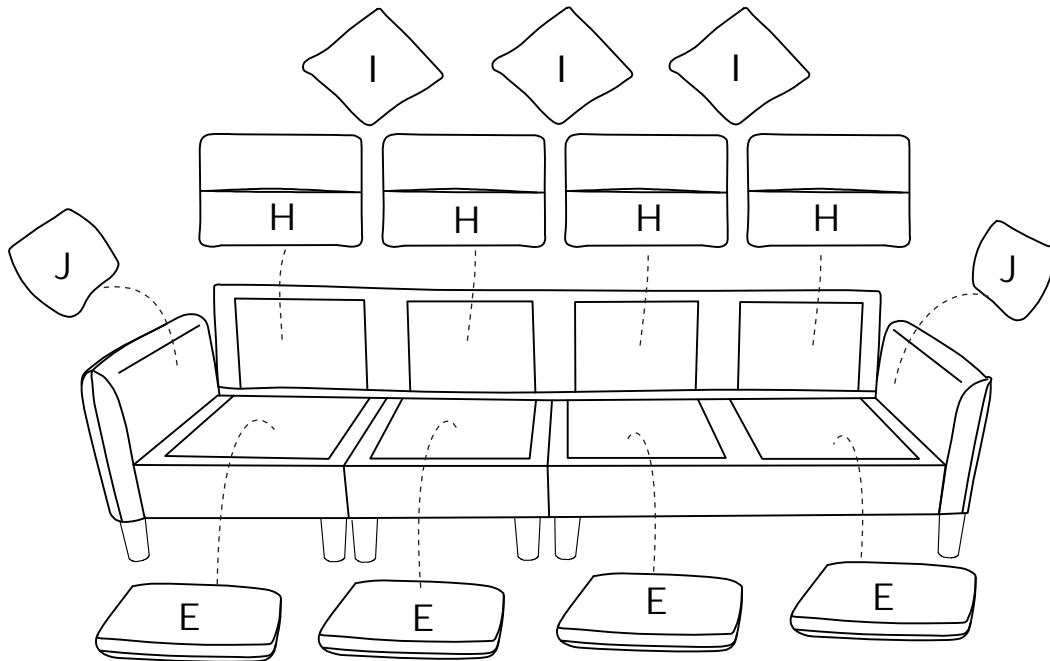
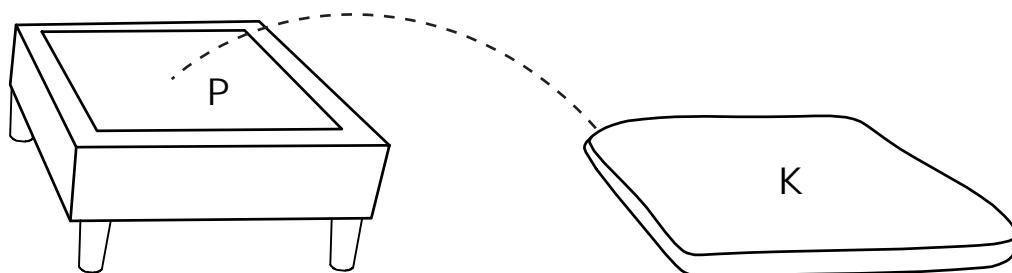

DIAGRAM 8 (Place the Cushion on the Ottoman)

Place the Ottoman cushion (Part K) on the Ottoman frame.



COMPLETE

