

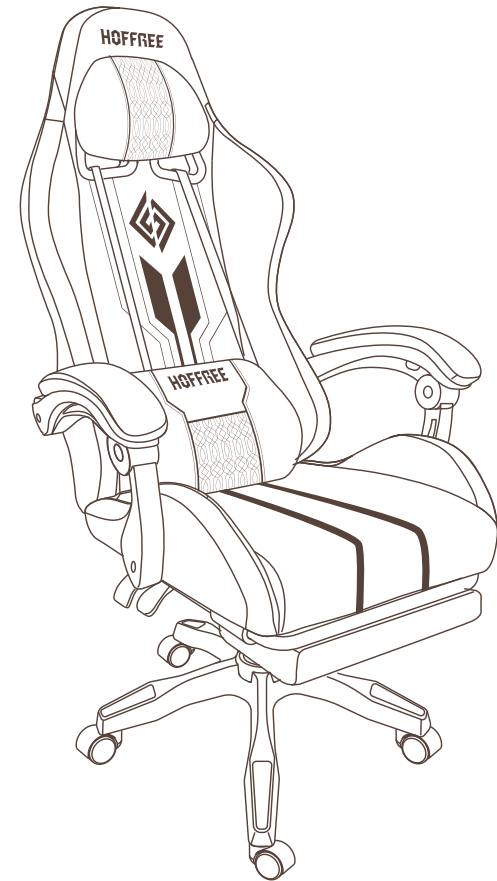

Hoffree, Provide the best office and home environment to you.



Massage



Gaming Chair

User Manual

MODEL:HOGC-MAX301

WHO ARE WE?

Hoffree is a brand that helps users enjoy life better.
Its slogan is Hoffree, Provide the best office and home environment to you.

Our purpose is to create a comfortable office environment.

Through our efforts, we have a strong and stable design and production team. At present, gaming chair, computer desk, bookcase and other products of Hoffree have become one of the hot products in the market.



Hoffree, Provide the best office and home environment to you.

Please believe that we can further improve our products and services with your accompany, so as to provide better customer experience.

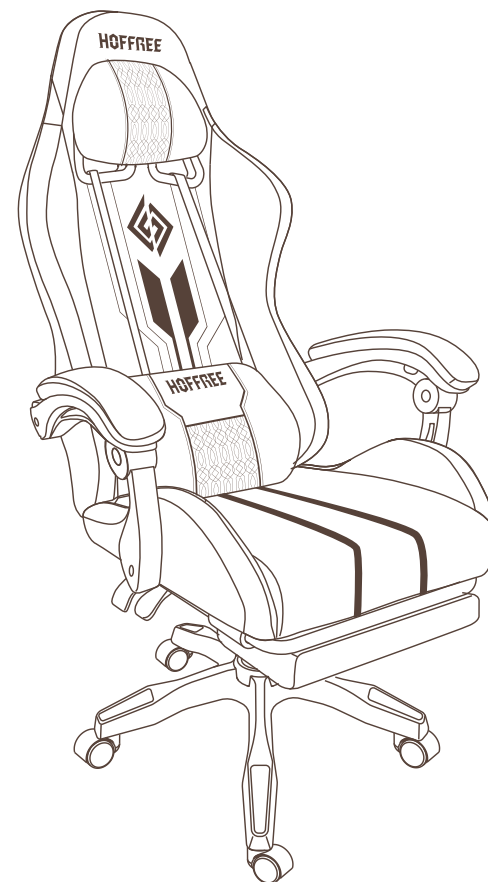

Product specification

Brand: Hoffree
 Product Name: Gaming Chair
 Gross weight: 19.5kg / 42.99lbs
 Weight Capacity: 180kg / 400lbs

Product Dimensions: 26.38*26.38*51.57in
 Working power Supply: 5V/2A
 charging pad as the main power supply

! ATTENTION

Some screws are pre-installed on the chair and are NOT included in the hardware pack.







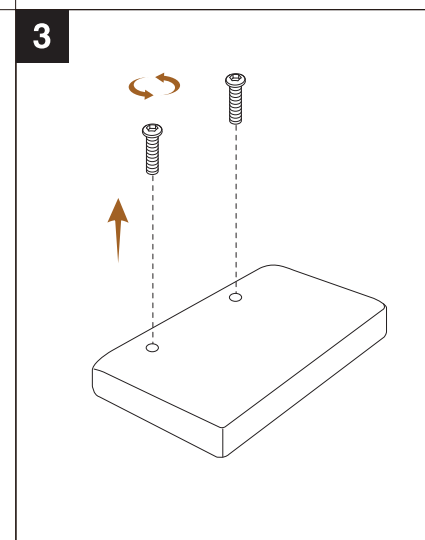
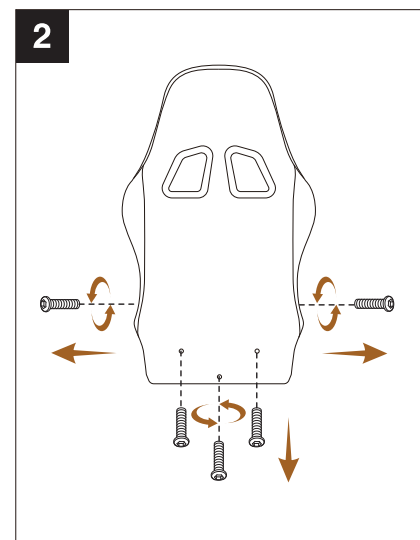
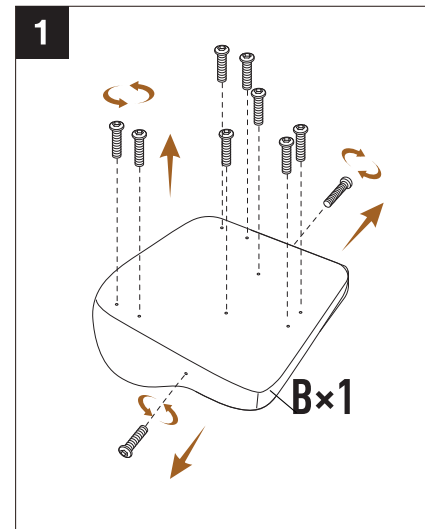



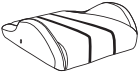
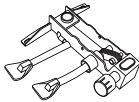
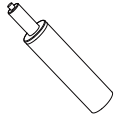
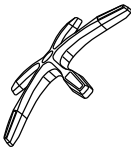
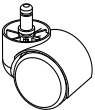
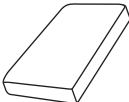
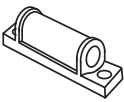
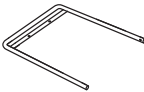

Please check the screw number according to the instruction manual and look for it on the chair!

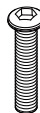
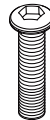

Please remove the pre-installed screws before installation

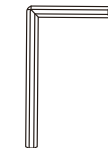

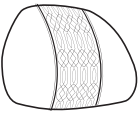
PACKING LIST

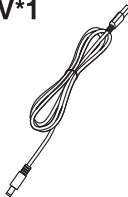
A*1 	B*1 	D*1 	E*1 	F*1 
G*5 	R*1 	Y*2 	T*1 	C-R*1 
C-L*1 	H*4  6*20mm	P*3  6*40mm	J*4  8*40mm	X*4  6*25mm
S*2  6*30mm	W*2 	L*1 	K*1 	M*1 
N*1 	Q*4 	V*1 		

INSTALLATION

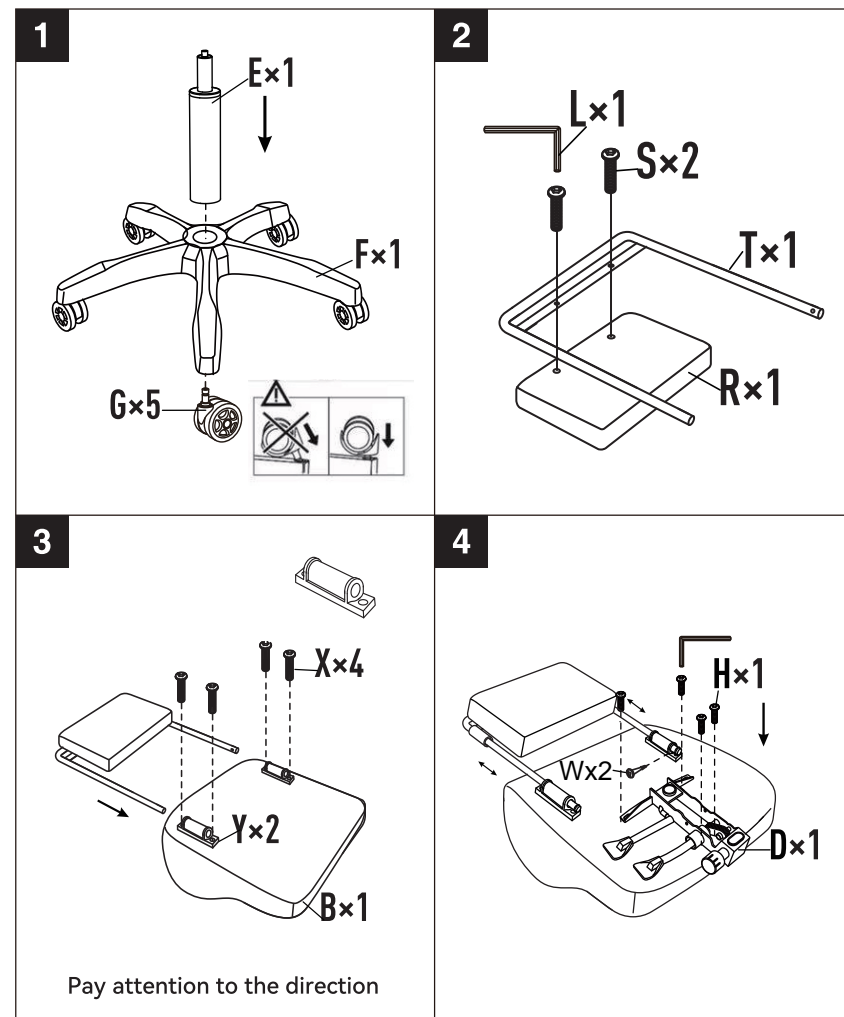

Note: All screws have been preassembled to the accessories. Please remove them from the accessories before assembling.

INSTALLATION

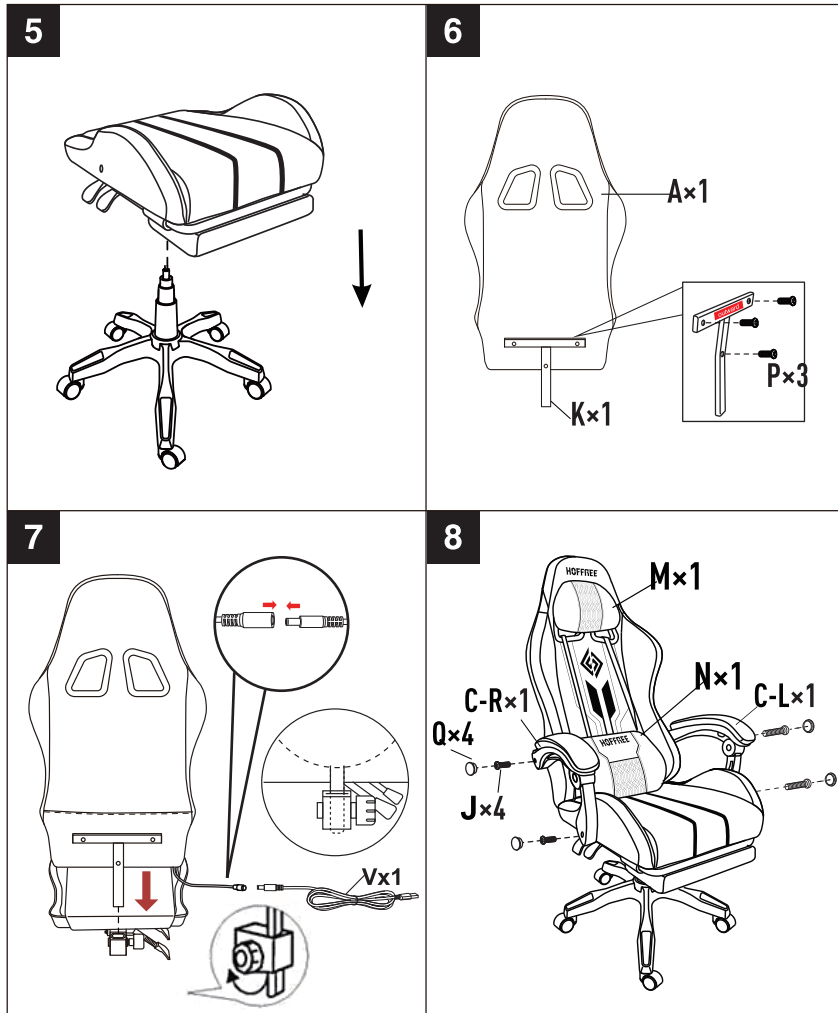

Note: All screws have been preassembled to the accessories. Please remove them from the accessories before assembling.

WARRANTY & SUPPORT

Thanks for purchasing our product. For any advice about the product or want to know other products of *Hoffree*.

Please visit *Hoffree* Amazon.

Your purchase and support will be our driving force!