

ASSEMBLY INSTRUCTION

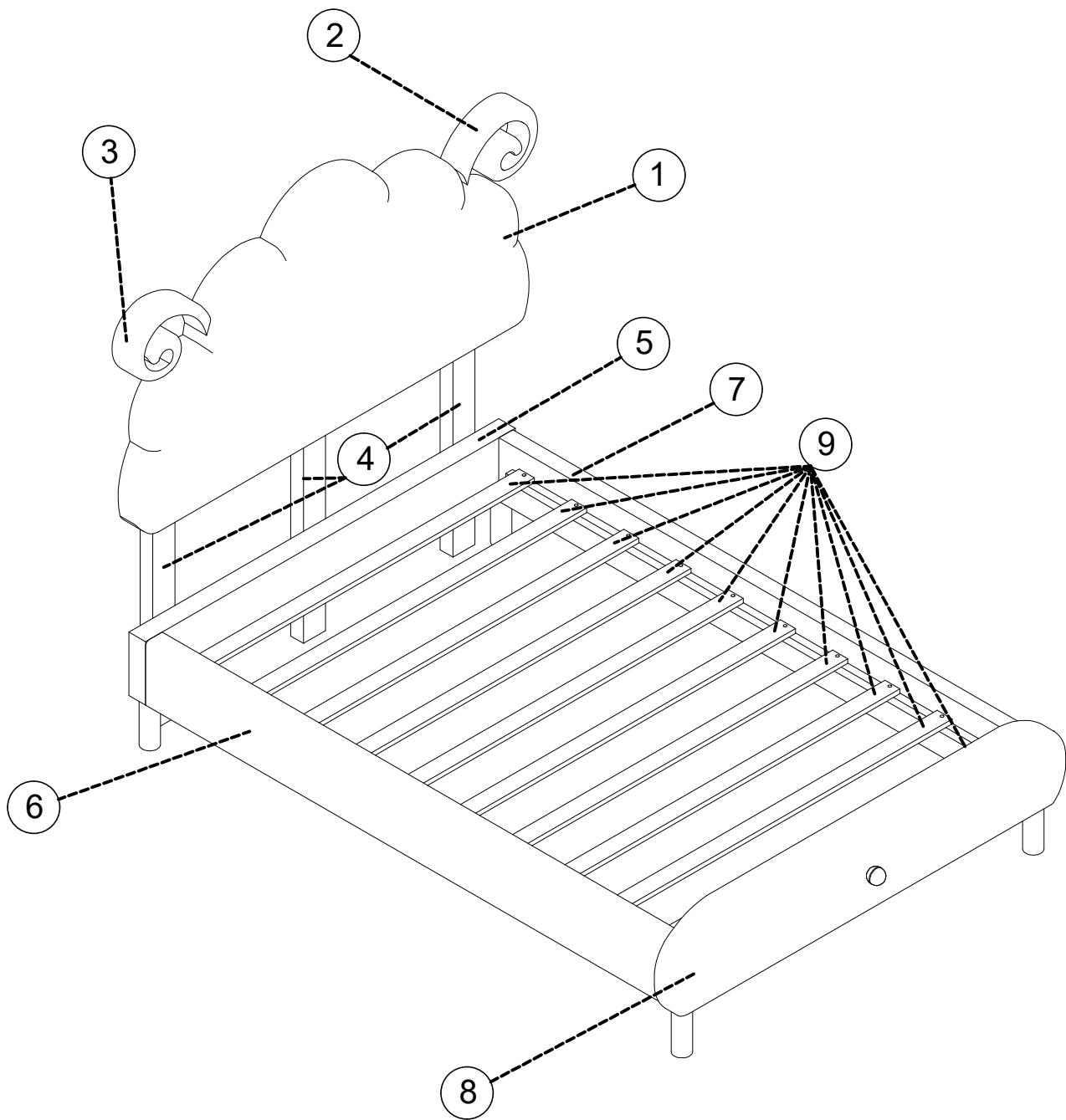

This set included 2 boxex if do not receive full 2 boxex. Please contact our customer service team





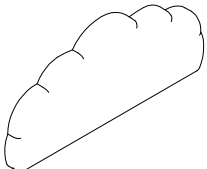
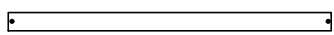

Part List

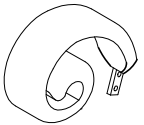
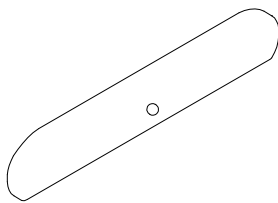
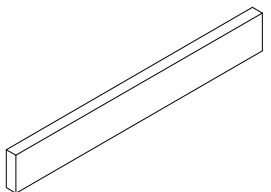
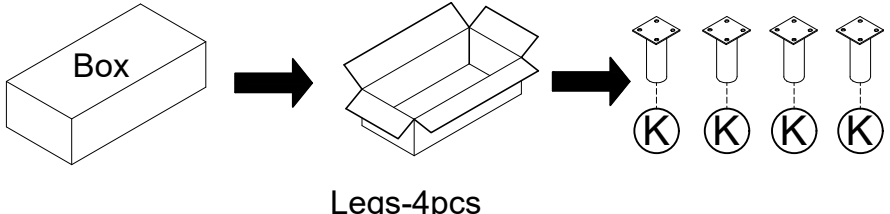
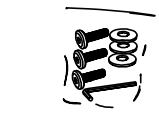
BOX 1/2:

1  Head board -1pc	9  Slates-10pcs	2  Wing board Right-1pc
3  Wing board Left-1pc	8  Footboard-1pc	5  Head board below-1pc
K  Legs-4pcs		Hardware 

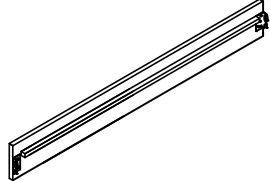
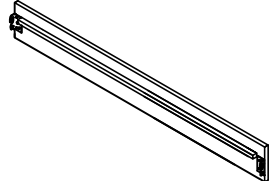







BOX 2/2:

6  Side rail Left - 1pc	7  Side rail Right - 1pc	4  Head board legs -3pcs
--	---	---





HARDWARE

Check that you've received
all hardware listed below.

Hardware List



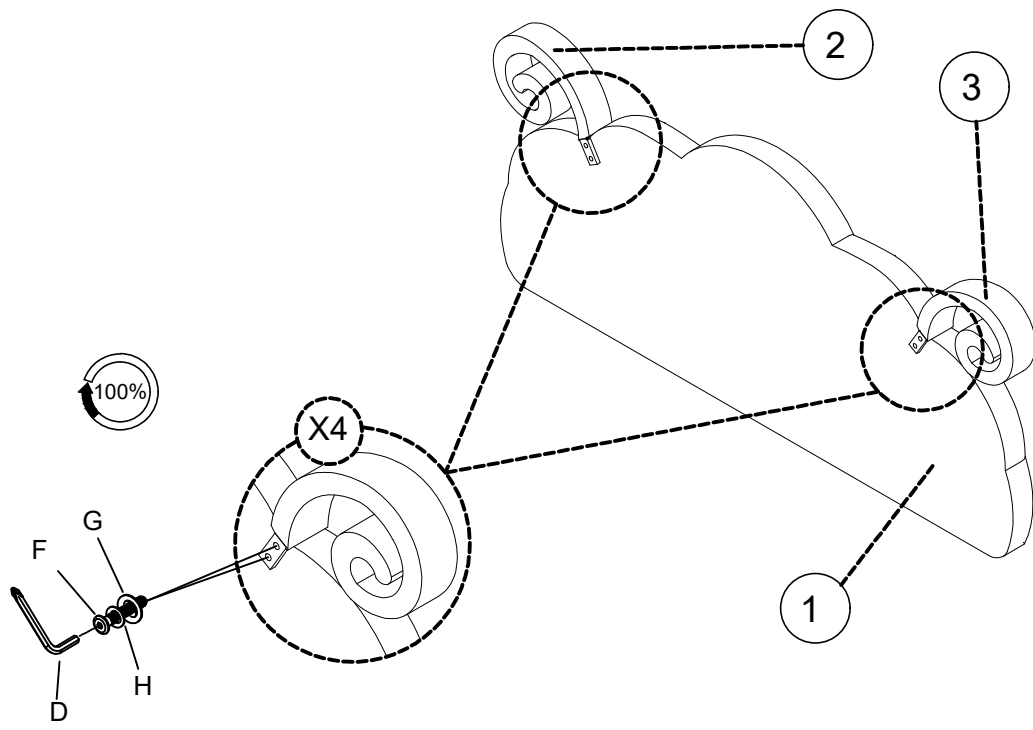

No.	OUTLOOK	DESC	QTY
(A)		Bolts 5/16"x30 mm	8
(B)		Plain washer Ø5/16"x19x1.5 mm	23
(C)		Spring washer Ø5/16"x12 mm	23
(D)		Allen key 80x30x4 mm	1
(E)		Bolts 5/16"x45 mm	15
(F)		Bolts 1/4"x30 mm	12
(G)		Plain washer Ø1/4"x19x1.5 mm	16
(H)		Spring washer Ø1/4"x10 mm	12
(I)		Screws Ø4x30 mm	24

STEP 1

F x 4	G x 4	H x 4	D x 1
			





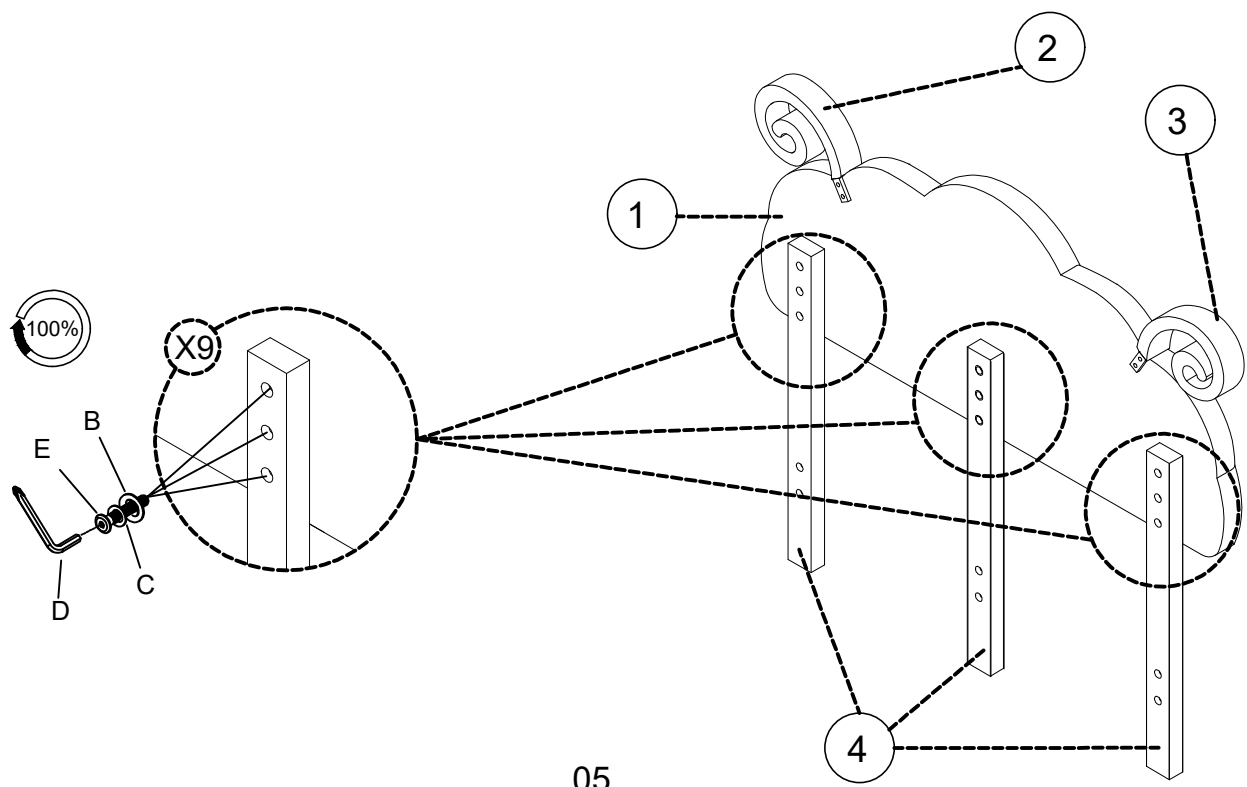

STEP 2

E x 9	B x 9	C x 9	D x 1
			





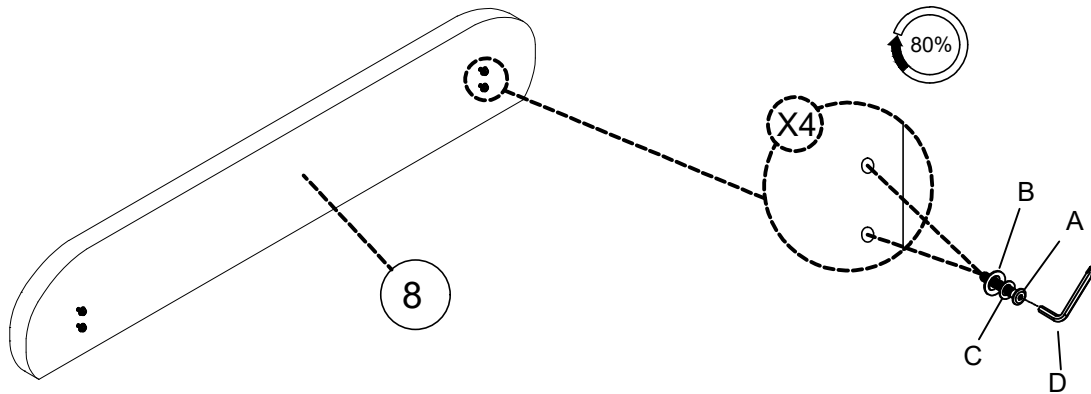

STEP 3

A x 4	B x 4	C x 4	D x 1
			



STEP 4

A x 4	B x 4	C x 4	D x 1
			

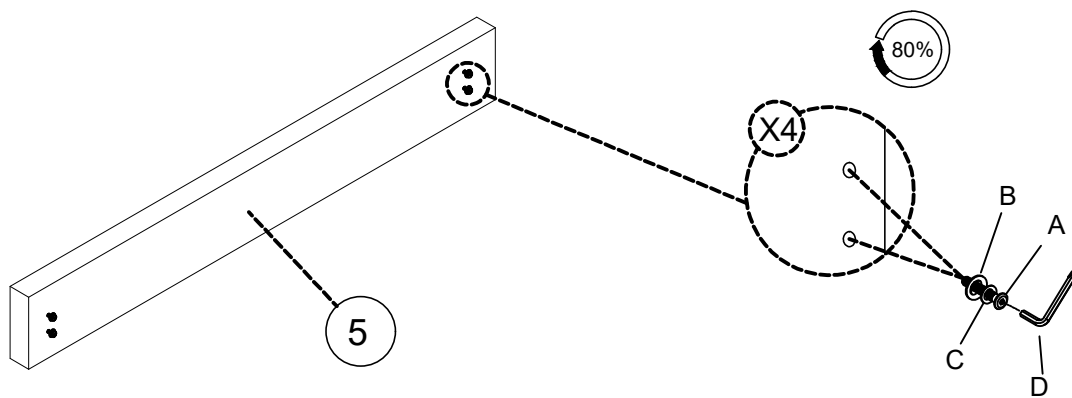



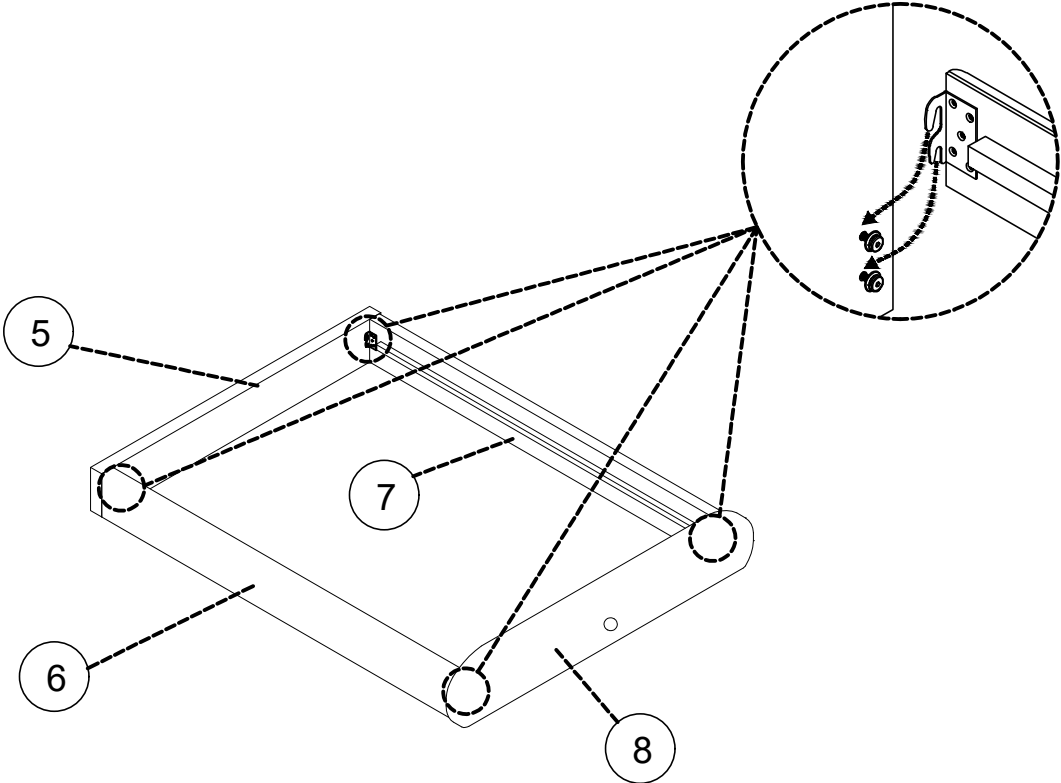

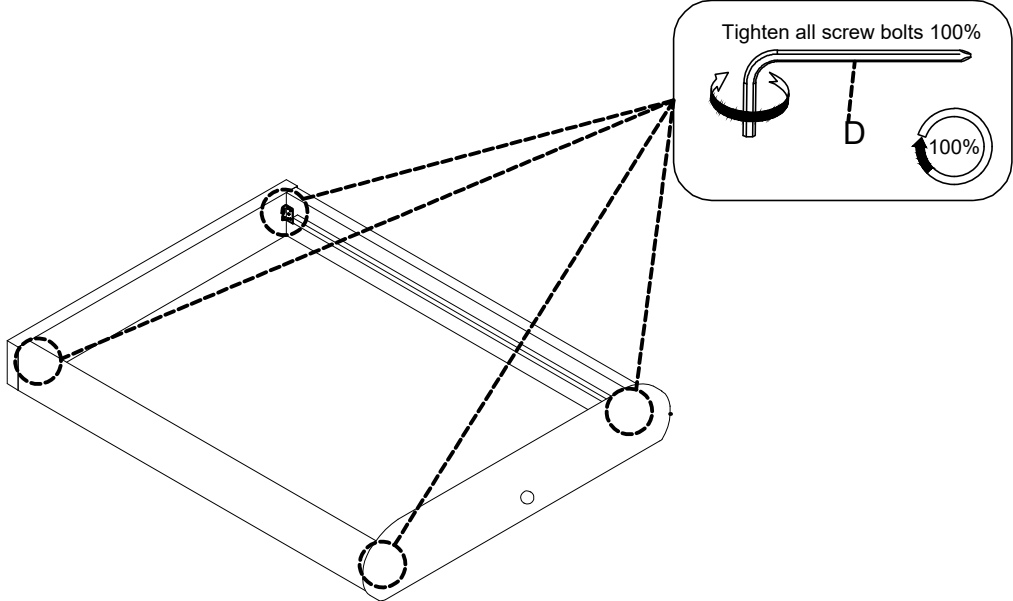

STEP 5



STEP 6





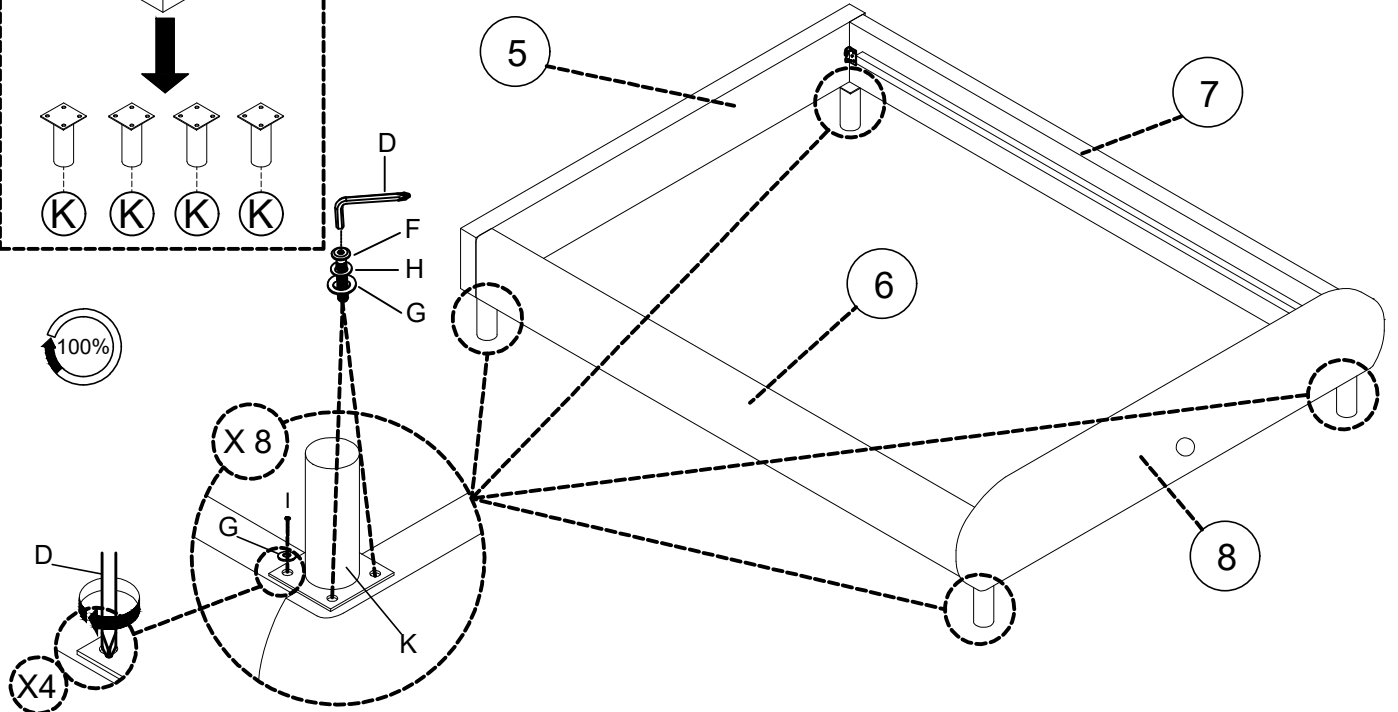
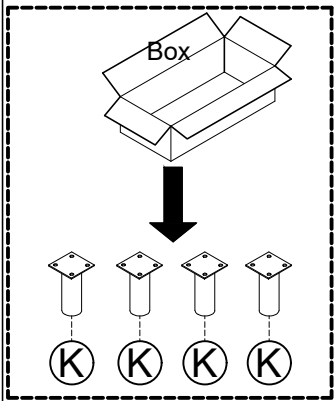

STEP 7

F x 8 	G x 12 	H x 8 	D x 1 	K x 4 	I x 4 
--	---	--	---	--	--



STEP 8

E x 6 	B x 6 	C x 6 	D x 1 
--	--	--	---

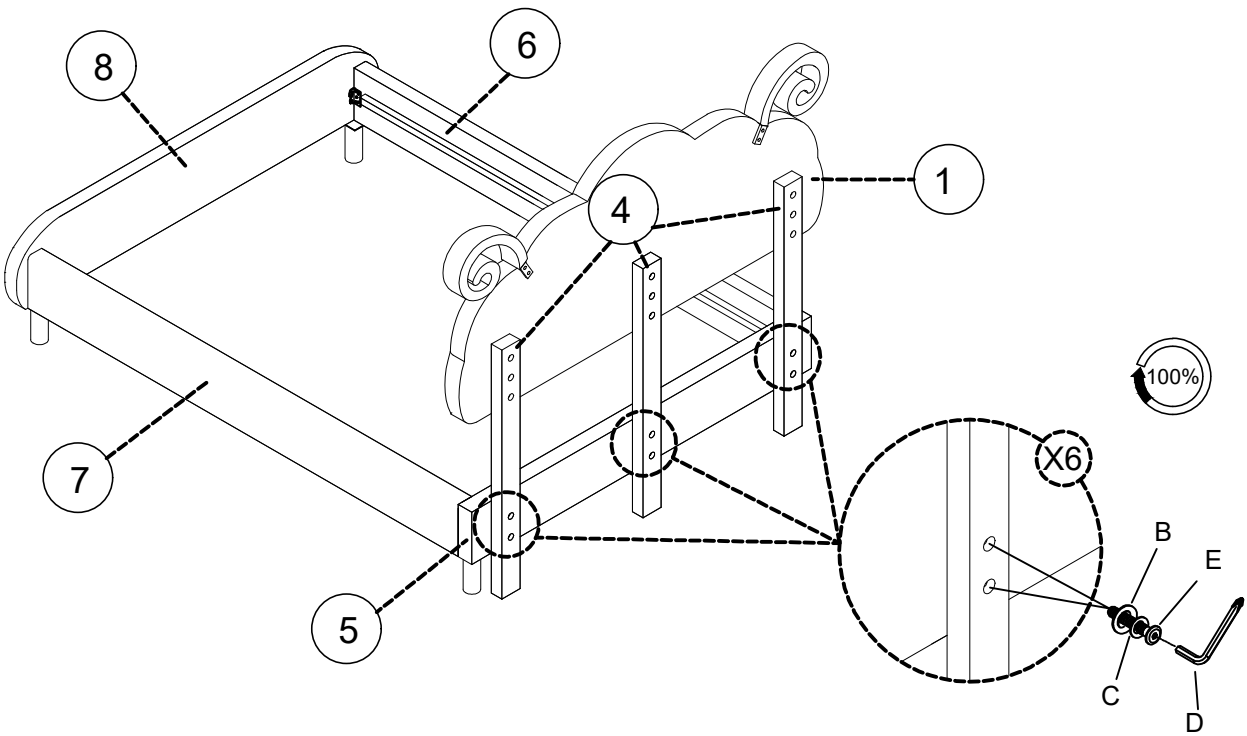

STEP 9

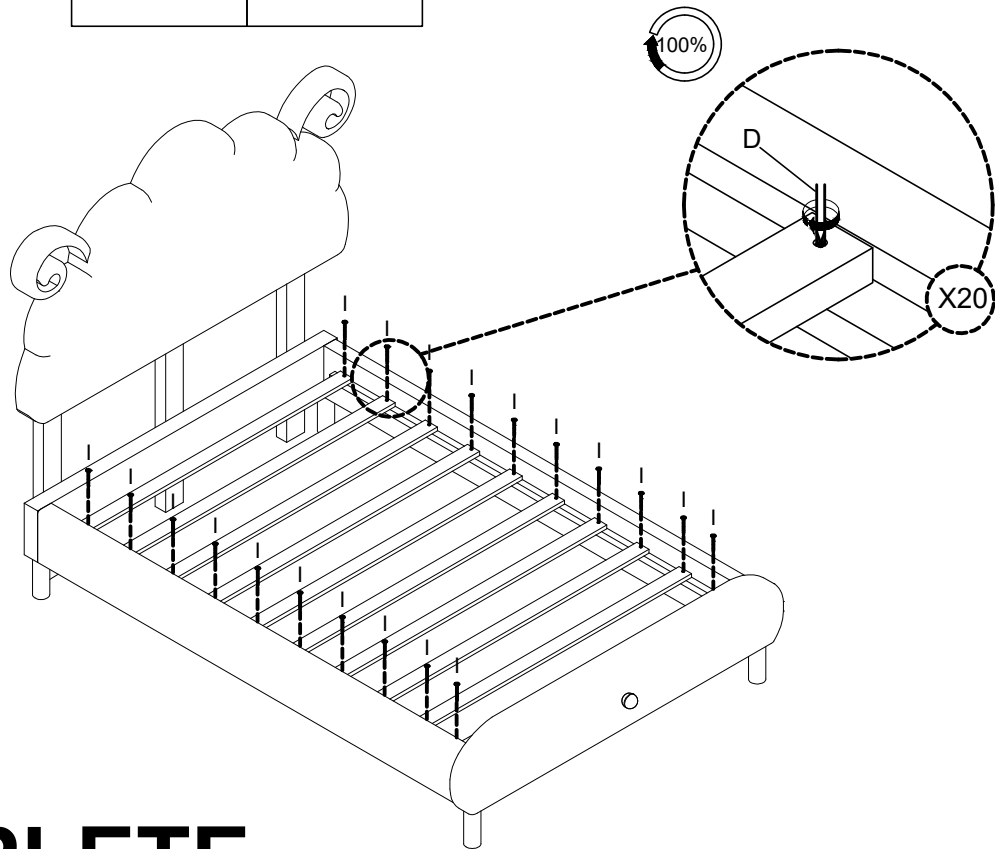
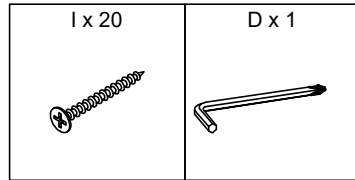

COMPLETE

