

Pure & Easy



ASSEMBLY INSTRUCTIONS

NOTICE

IMPORTANT, RETAIN FOR FUTURE REFERENCE: READ CAREFULLY
WICHTIG, FÜR SPÄTERE NACHSCHLAGE AUFBEWAHREN: SORGFÄLTIG LESEN
IMPORTANTE, GUARDAR PARA REFERENCIA FUTURA: LEER ATENTAMENTE
IMPORTANTE, CONSERVARE PER RIFERIMENTI FUTURI: LEGGERE ATTENTAMENTE
IMPORTANT, À CONSERVER POUR RÉFÉRENCE FUTURE : LIRE ATTENTIVEMENT

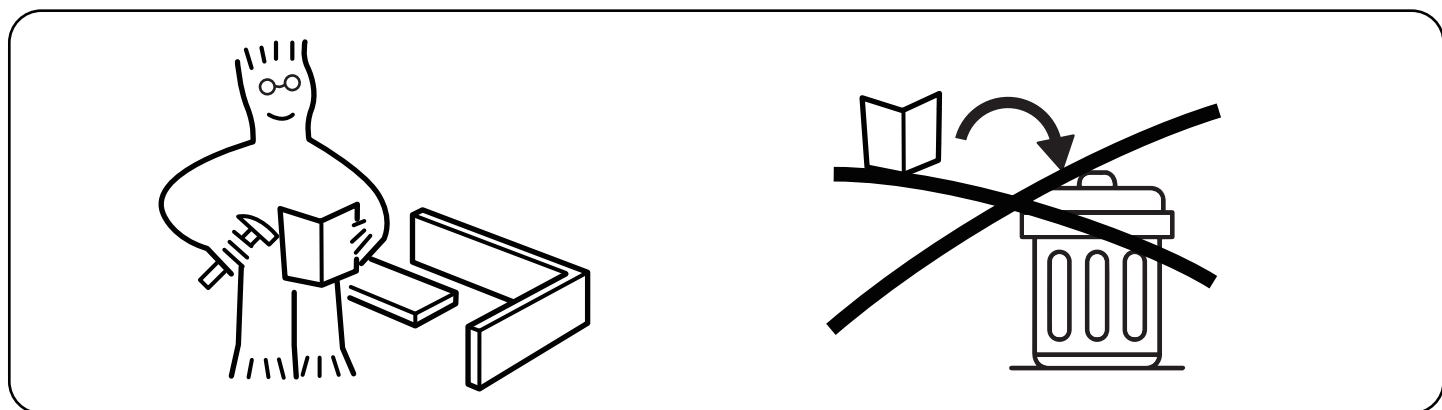

Assemble on a flat and solid surface. To avoid the unstable surface affecting the overall frame stability during installation.

Montieren Sie auf einer ebenen und festen Oberfläche. Um zu verhindern, dass eine unebene Oberfläche während der Montage die Gesamtrahmen-Stabilität beeinträchtigt.

Ensamblar en una superficie plana y sólida. Afin d'éviter que la surface inégale n'affecte la stabilité générale du cadre lors de l'installation.

Assemblare su una superficie piana e solida. Per evitare che una superficie irregolare influisca sulla stabilità complessiva della struttura durante l'installazione.

Assemble sur une surface plate et solide. Para evitar que la instalación en una superficie irregular afecte la estabilidad general del marco.

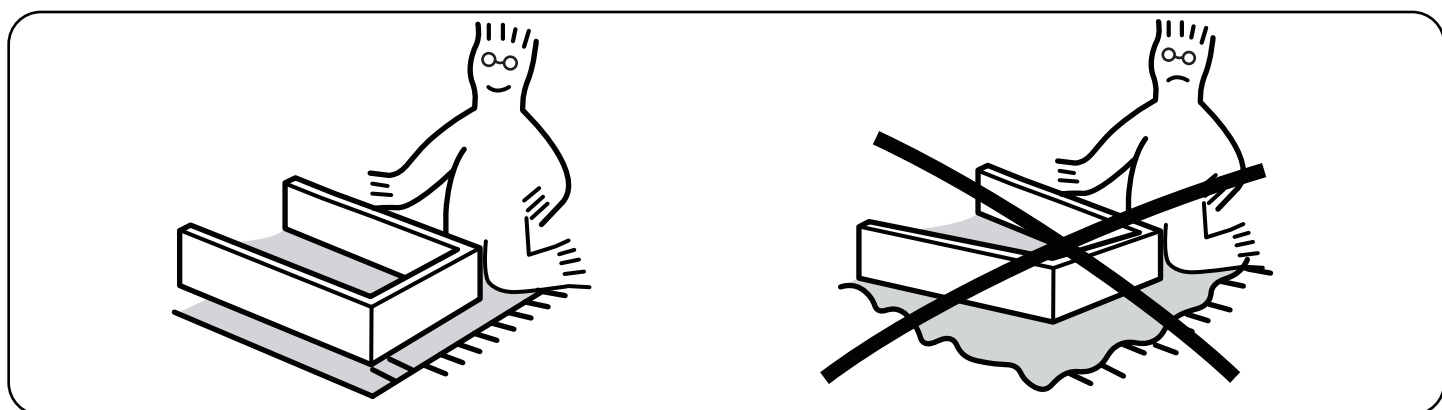

Professional installation is highly recommended.

Eine professionelle Installation wird dringend empfohlen.

Une installation professionnelle est fortement recommandée.

Si raccomanda vivamente l'installazione professionale.

Se recomienda altamente la instalación profesional.



Periodically Check That All Components Are Tightly Secured.
Überprüfen Sie Regelmäßig, Dass Alle Komponenten Fest Gesichert Sind.
Vérifiez Périodiquement Que Tous Les Composants Sont Bien Fixés.
Controllare Periodicamente Che Tutti I Componenti Siano Ben Fissati.
Verifique Periódicamente Que Todos Los Componentes Estén Bien Asegurados.

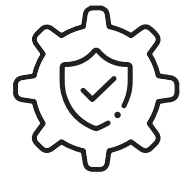

It is recommended that multiple people assemble this product.
Es wird empfohlen, dass mehrere Personen dieses Produkt zusammenbauen.
Il est recommandé que plusieurs personnes assemblent ce produit.
Si raccomanda che più persone assemblino questo prodotto.
Se recomienda que varias personas ensambren este producto.

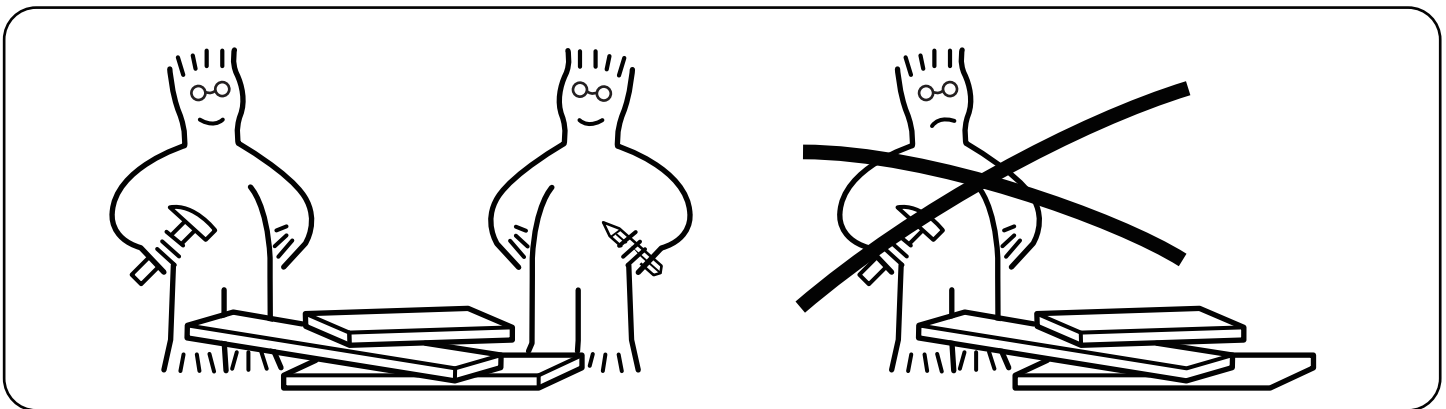

Please contact us if parts of your furniture are missing.
Bitte kontaktieren Sie uns, wenn Teile Ihrer Möbel fehlen.
Por favor contáctenos si faltan piezas de sus muebles.
Si prega di contattarci se mancano parti dei vostri mobili.
Veuillez nous contacter si des pièces de vos meubles manquent.



Please have the following auxiliary tools ready:

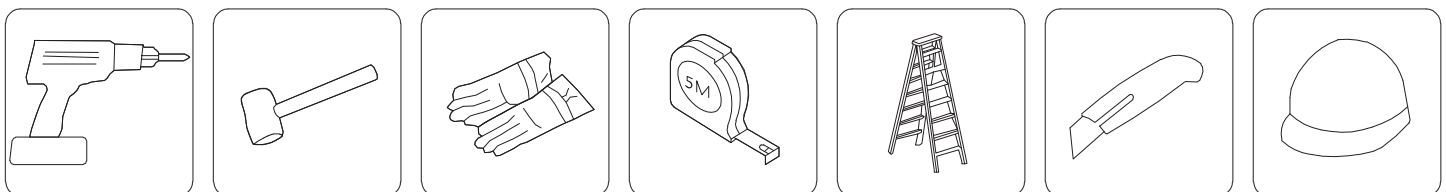



WARNING

- Installation on solid, level ground (e.g., concrete or pavers) is strongly recommended.
 - On hard surfaces (e.g., concrete), secure each leg with 3 expansion bolts.
 - On grass or compacted soil, secure each leg with 3 ground stakes.

****Note**** Installing directly on soil or grass may lead to settling, tilting, or even collapse over time due to seasonal ground movement. For soft surfaces, we strongly recommend using spiral stakes or ground augers (sold separately) to secure the structure.

- Always place the gazebo on level ground and maintain a minimum clearance of 6 feet (1.8 m) from fences, walls, houses, trees, power lines, laundry lines, or other obstructions.
- Inspect all bolts, joints, and anchors every 90 days for looseness, rust, or damage. Tighten or replace as needed.
- ****Never**** climb on, shake, lean heavily against, or use the gazebo as a support structure.
- ****Do not use**** in high winds (>25 mph), heavy snow, storms, or severe weather. Remove canopy or disassemble if extreme conditions are expected. Clear snow immediately once it reaches 2 inches (5 cm) to avoid damage or collapse.
- Keep away from open flames, grills, or fire hazards. Fabric parts may ignite easily.
- This product is not a toy. Supervise children at all times.
- Failure to follow these instructions may result in property damage, serious injury, or death. Warranty does not cover damages caused by improper installation or misuse.

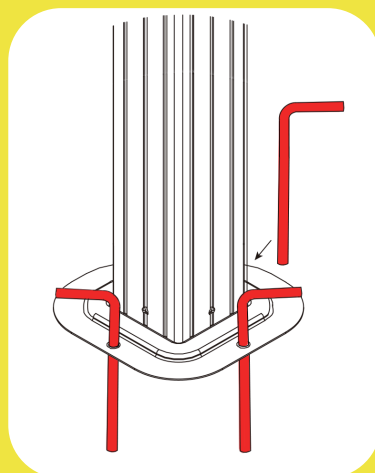
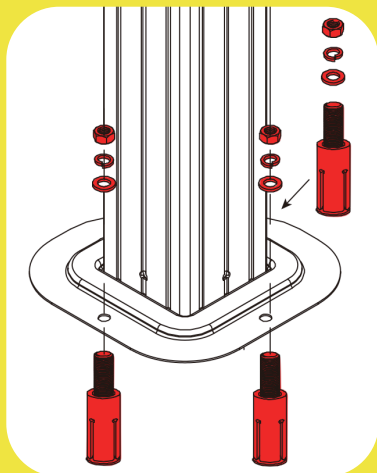



The following installation methods will provide better wind resistance performance, extend the product's lifespan, and help you maximize its value, delivering an even better user experience.

1

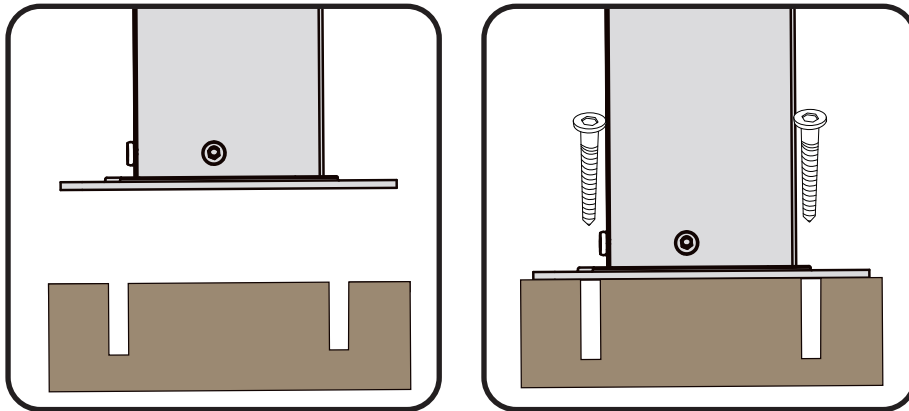



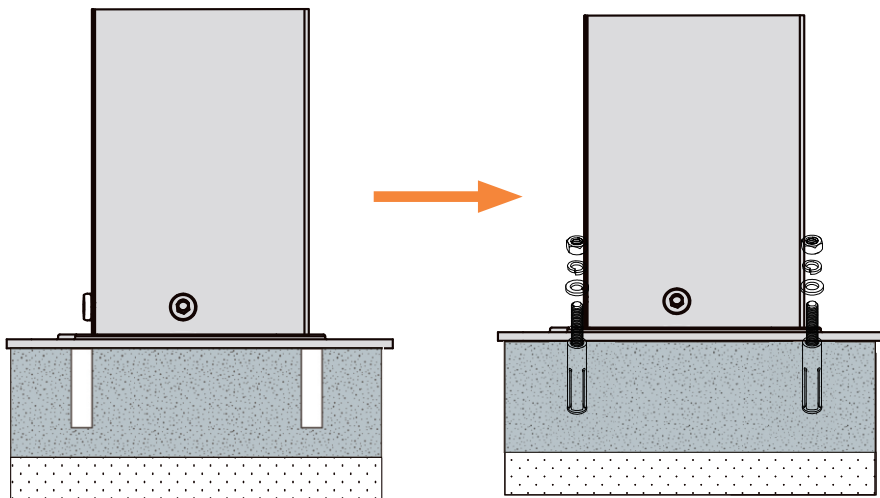









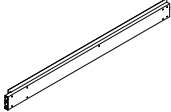

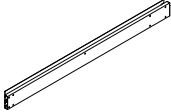
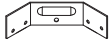



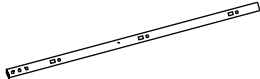

If the deck you are installing is made of hardwood and has a depth exceeding 40mm, you can use ST8*35mm screws to secure it in place. (This hardware is not included with the product, so you will need to purchase it separately.)

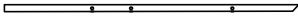
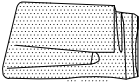

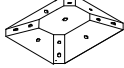

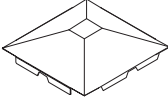

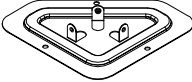



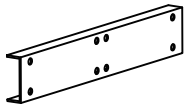

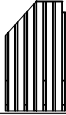
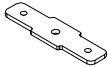



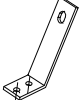







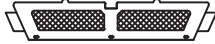



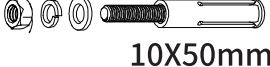

2





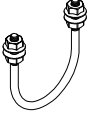

The best option is to fix it on a concrete surface. You can use the expansion bolts that are pre-configured with the product to secure it in place.

PARTS

Item no.	Reference Image	Qty.	Item no.	Reference Image	Qty.
A		X4	H		X4
B		X4	H1		X4
B1		X4	H2		X4
Ea		X4	K1		X4
Eb		X4	N		X12
E1		X4	N1		X4
E2		X4	T		X4
F1		X4	T1		X4
F2		X4	L		X1
G1		X4	M		X1
G3		X4	J		X4
G5		X4	G6		X4



Item no.	Reference Image	Qty.	Item no.	Reference Image	Qty.
P		X4	Q2		X4
W		X4	Q3		X4
W1		X4	Q4		X4
W2		X4	Q5		X4
W3		X4	Q6		X4
U		X96	V		X4
Y		X84	1	 M6X16mm	X172
Y1		X12	3	 M6X25mm	X85
V1		X2	4	 ST4.8X12mm	X8
V2		X2	5	 M6X10mm	X8
S		X4	9	 10X50mm	X12
Sa		X4	10	 M5X12mm	X52
Q1		X4	12	 S4	X1

Item no.	Reference Image	Qty.
13		X1
14		X12
15		X1
16		X24
21		X8
22		X8

Item no.	Reference Image	Qty.
17		X4
18		X4
19		X4
D		X4
C		X4
C1		X4

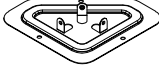
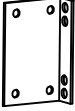

ASSEMBLY

1
X4

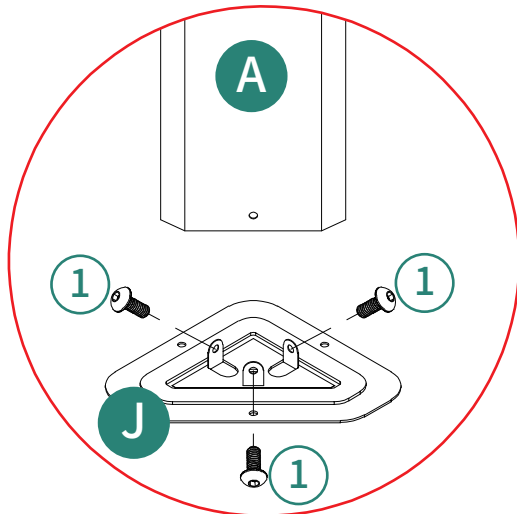
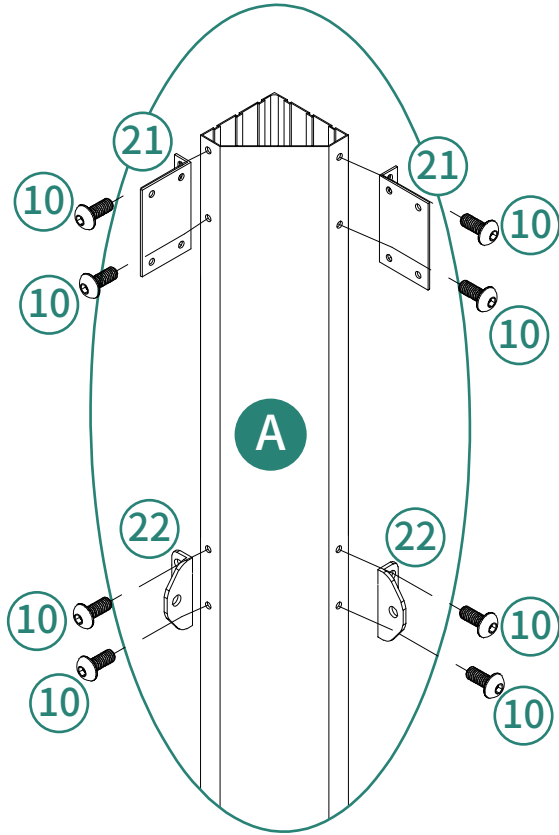
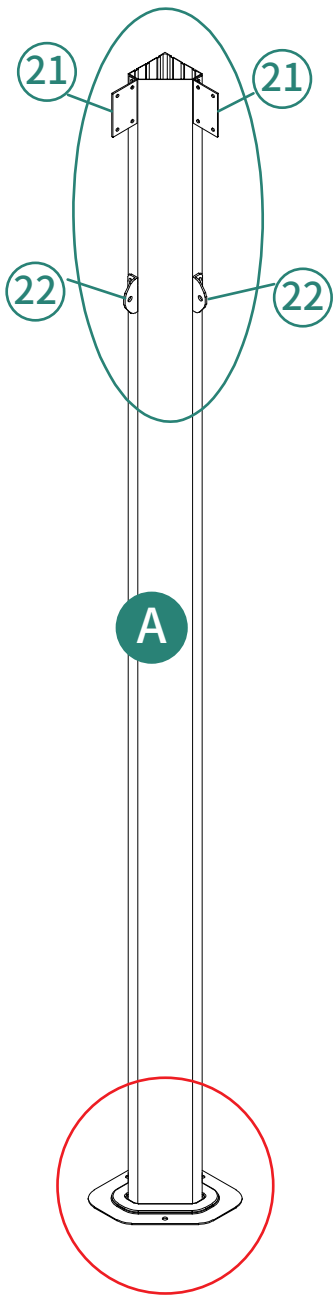
	M6x16mm				M5x12mm
Ⓐ 4pcs	① 12pcs	ⓙ 4pcs	⑳ 8pcs	㉓ 8pcs	⑩ 32pcs



3
X2

		M6x16mm
		
ⓂH 2pcs	ⓂH1 2pcs	① 24pcs

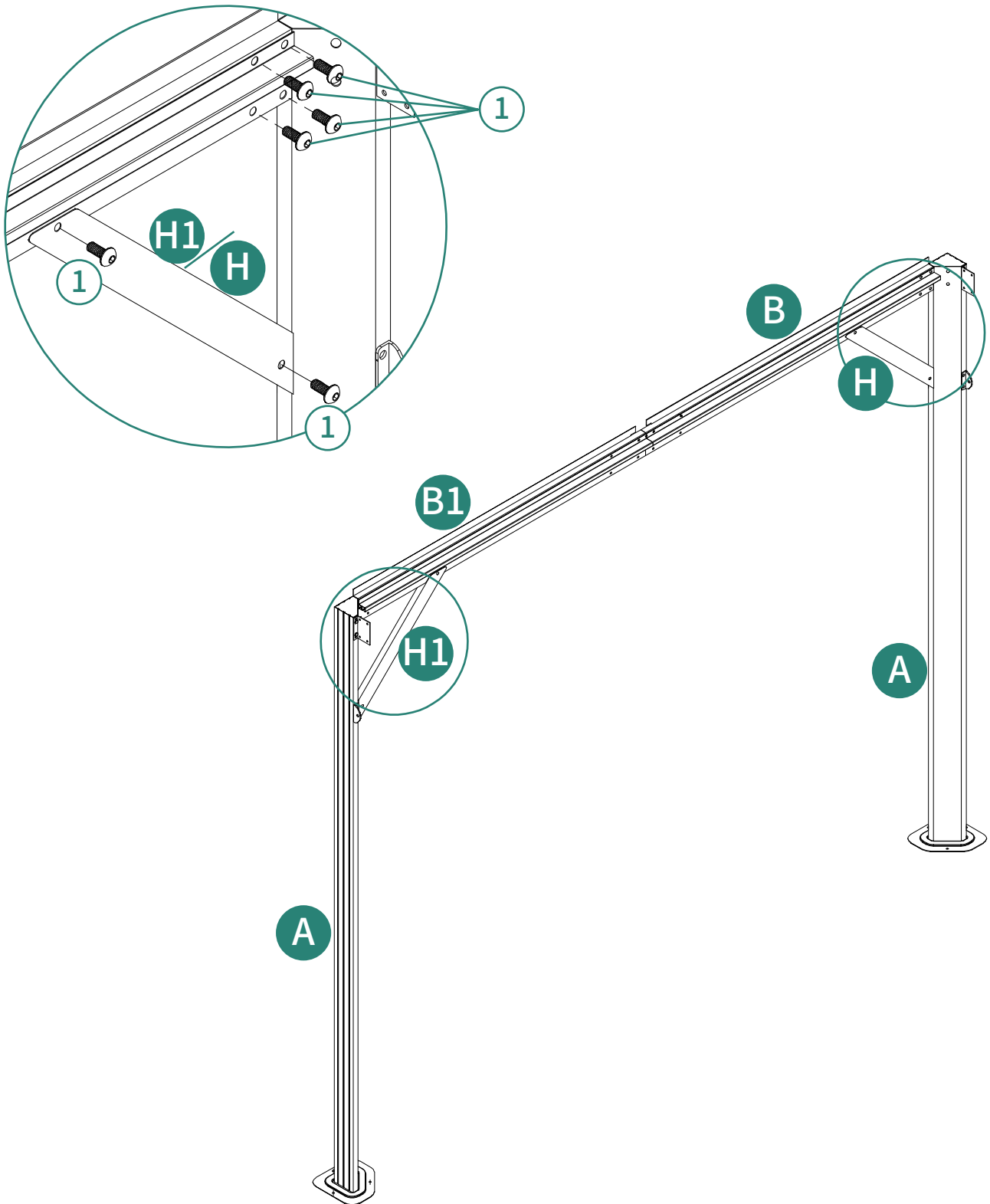

4



(H) 2pcs



(H1) 2pcs

M6x16mm



(1) 24pcs

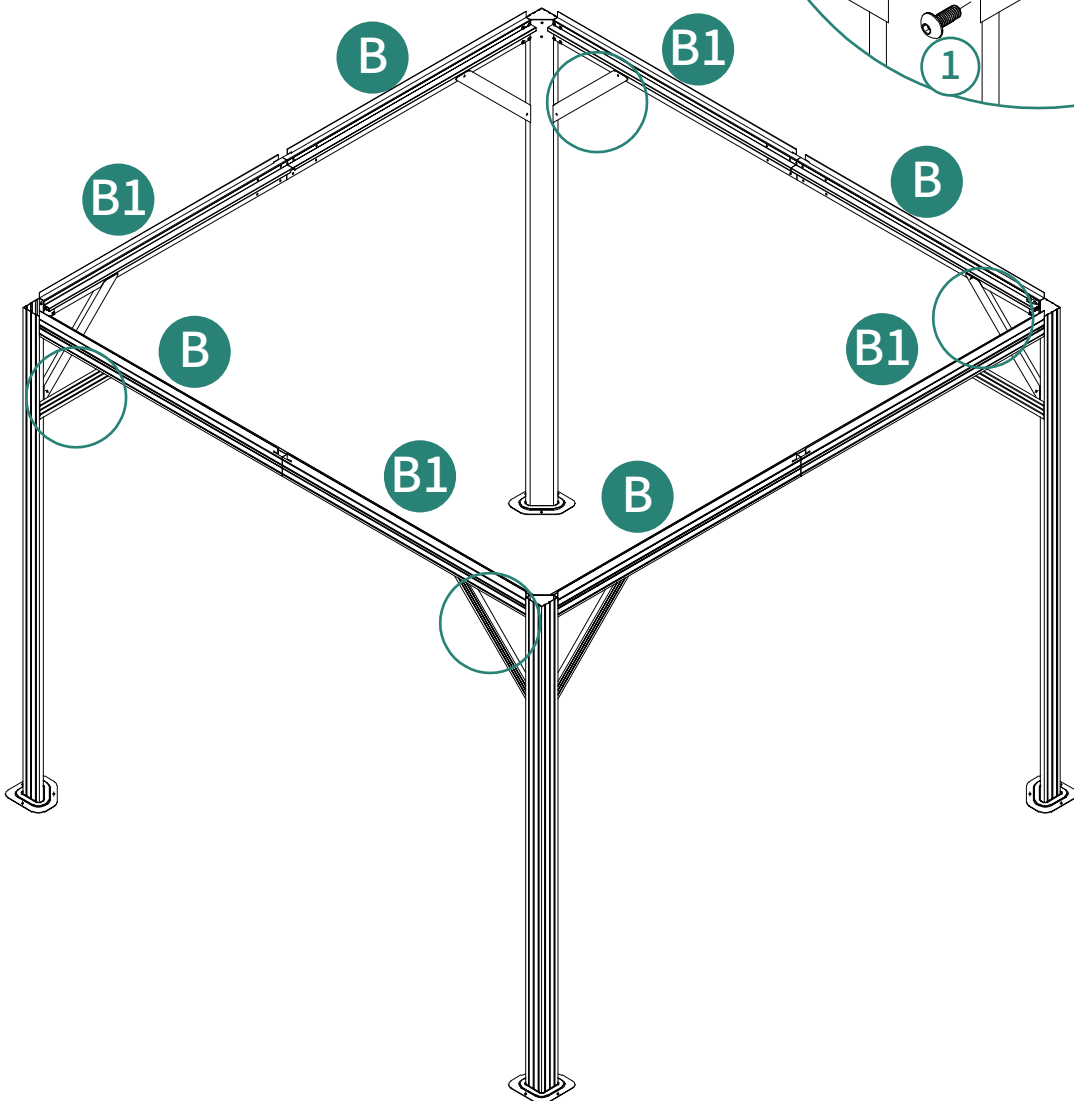
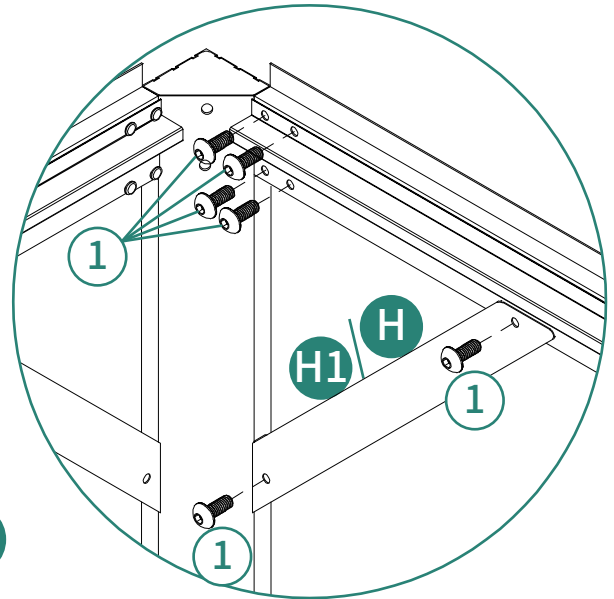

5

M6x16mm

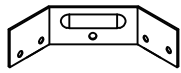

H2 4pcs

1 4pcs

Please remove these four screws, properly position the H2 accessory, and then re-secure it.

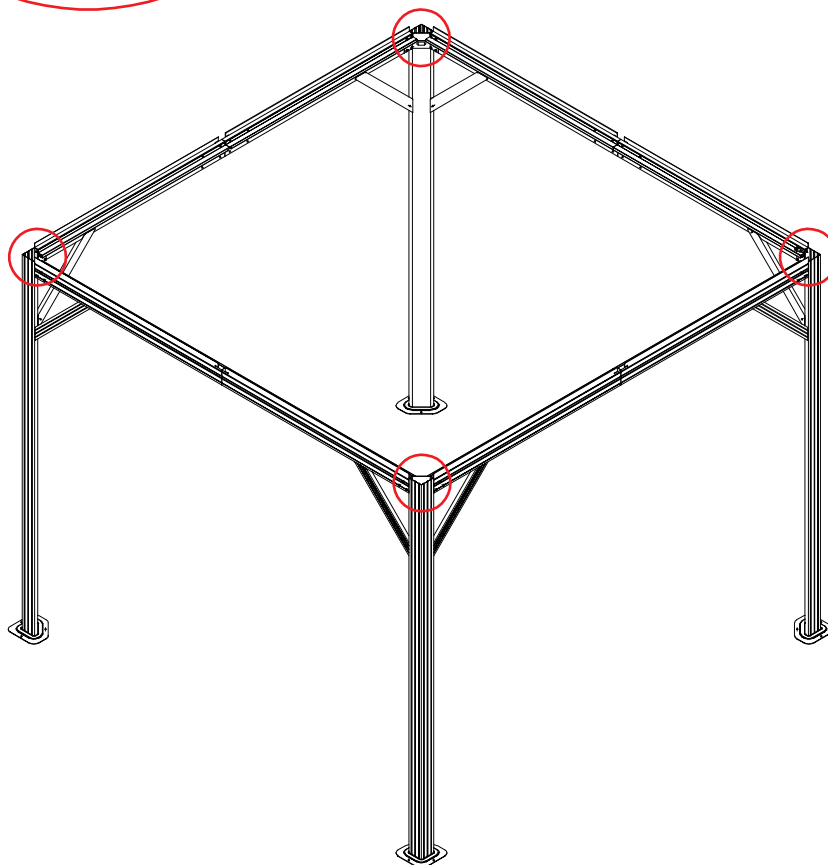
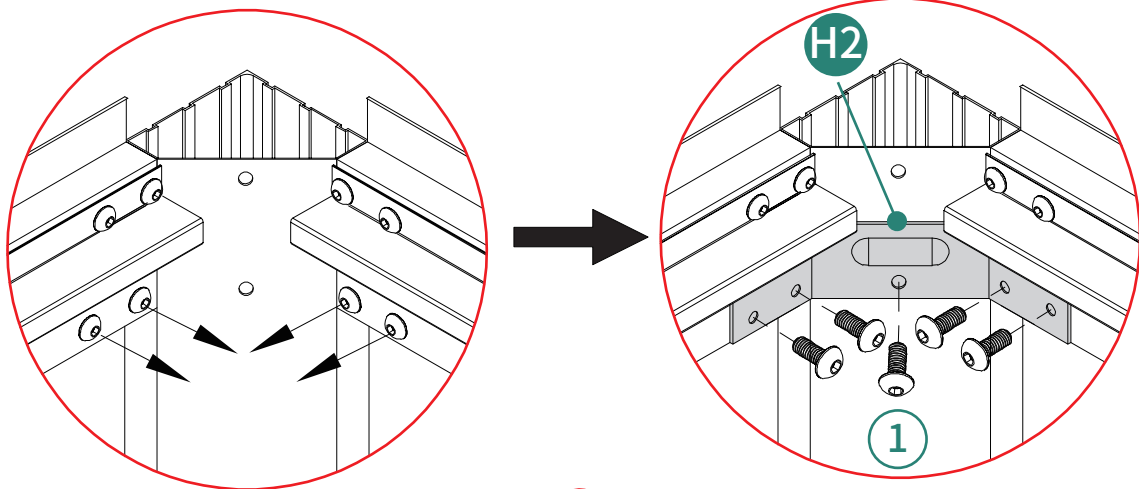

6

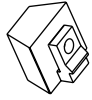

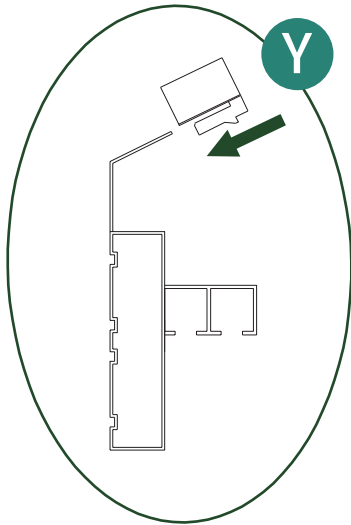

Y 48Pcs

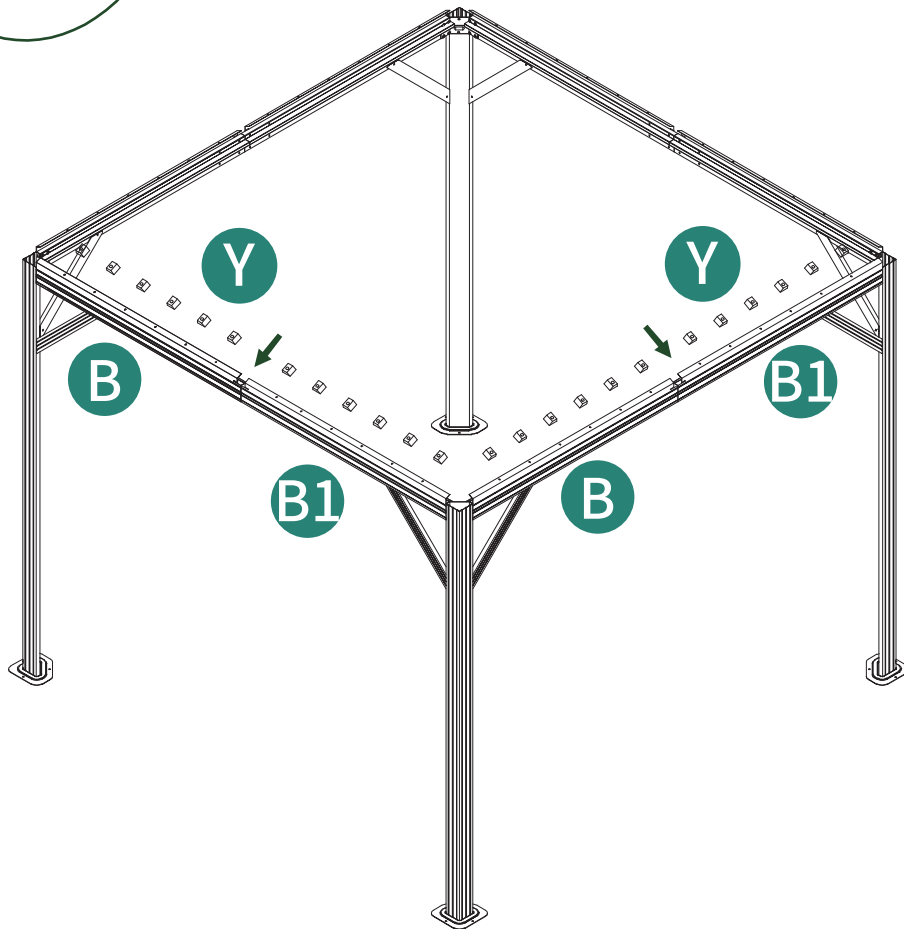

Insert the parts "Y" through the edges and align the circular hole.



7

	ST4.8x12mm			M5x12mm
⓪96pcs	④8pcs	Ⓥ4pcs	Ⓚ14pcs	⑩4pcs

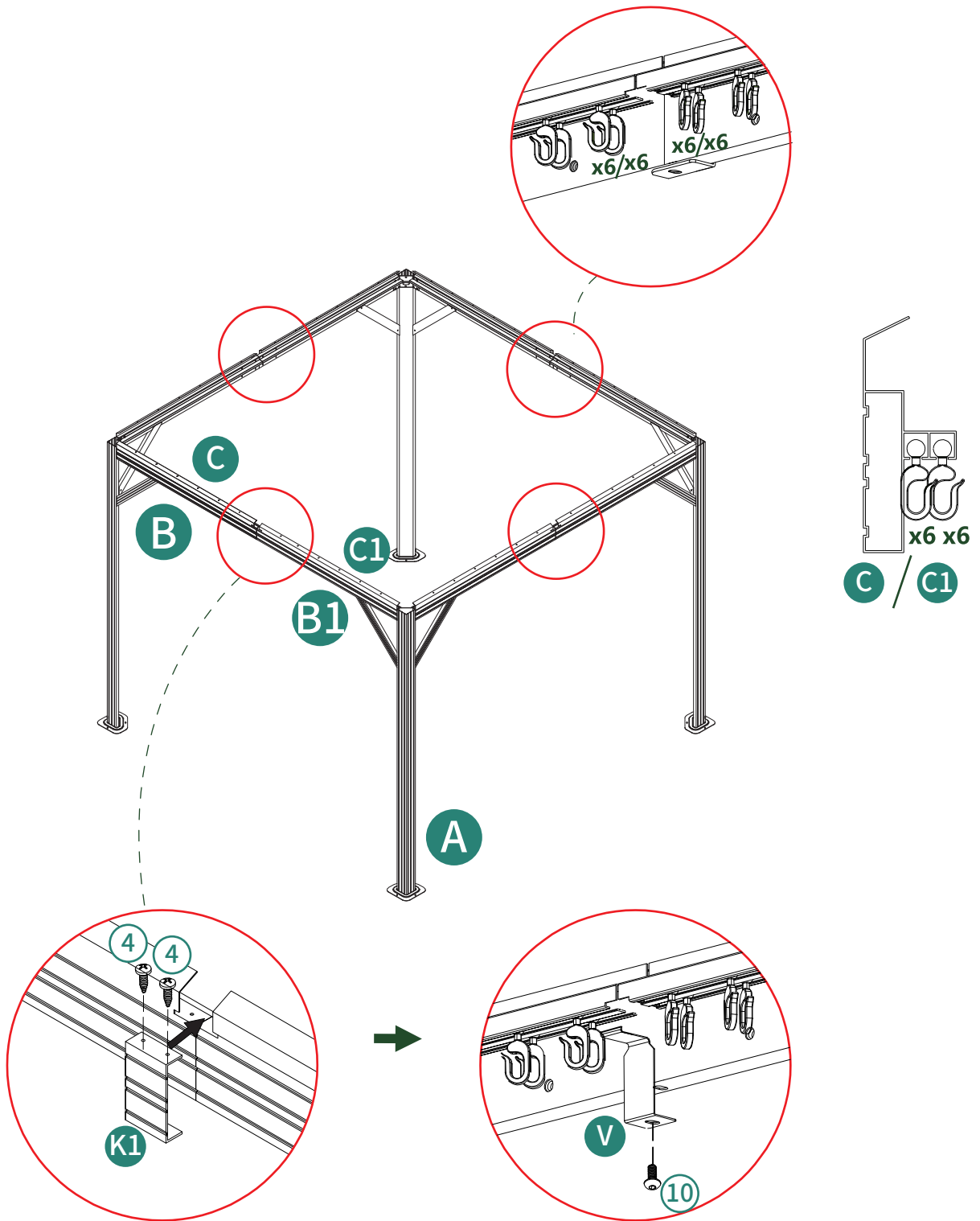

8

X4

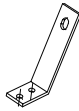

Ⓔa 4pcs Ⓔb 4pcs Ⓜ3 4pcs Ⓣ10 8pcs Ⓣ16 12pcs Ⓣ17 4pcs Ⓣ18 4pcs

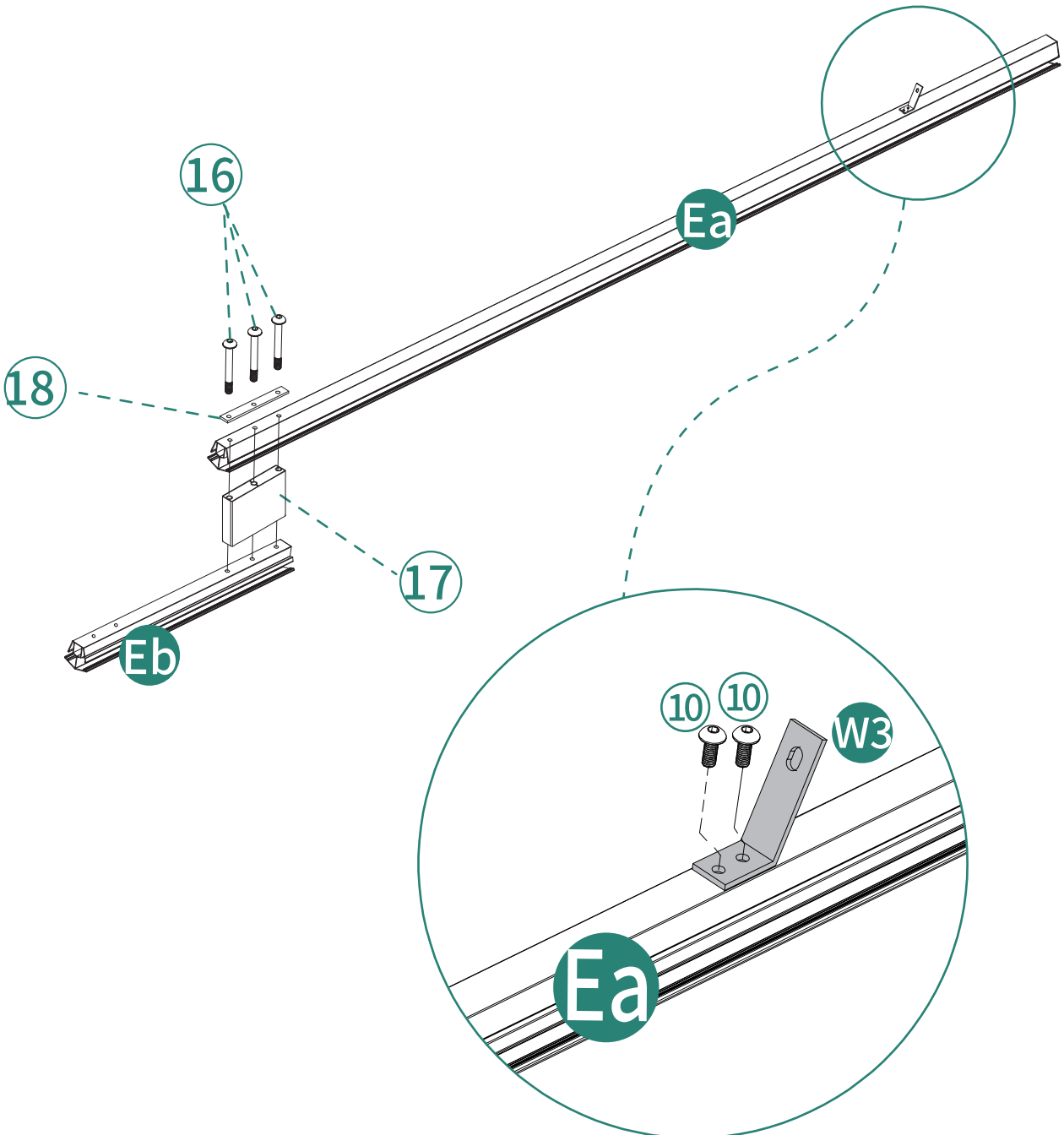

9

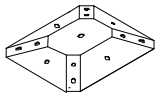

(L) 1pc

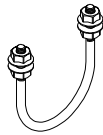

(15) 1pc

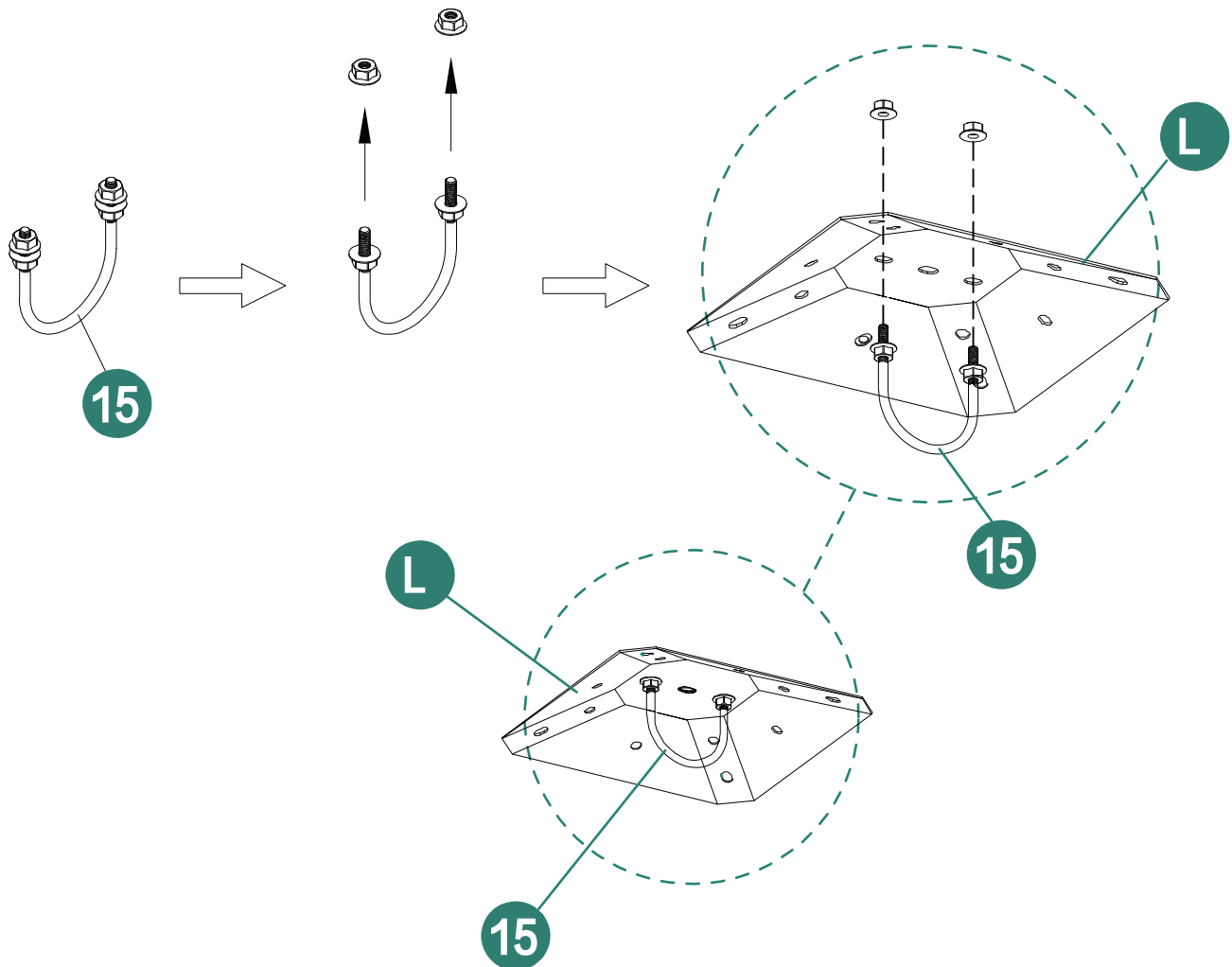

10



① 8pcs

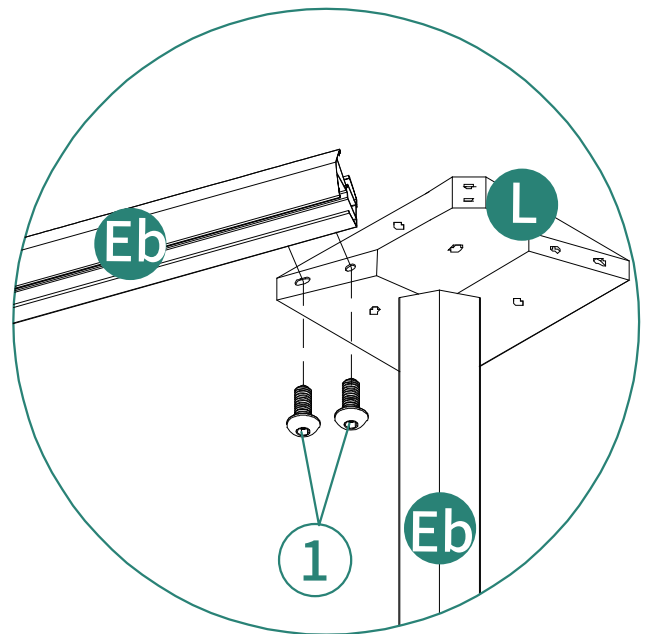
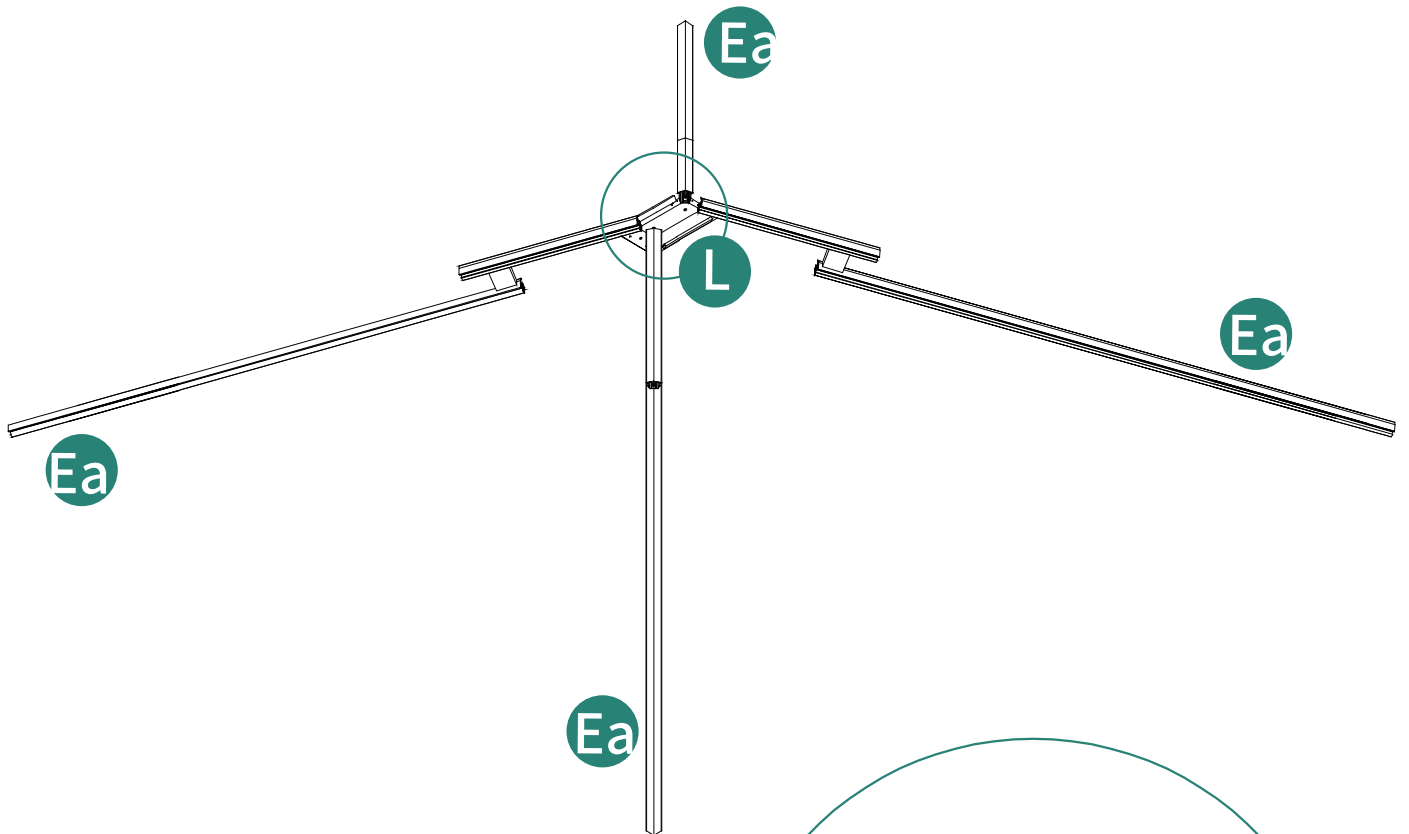

11

M6x16mm



① 4pcs

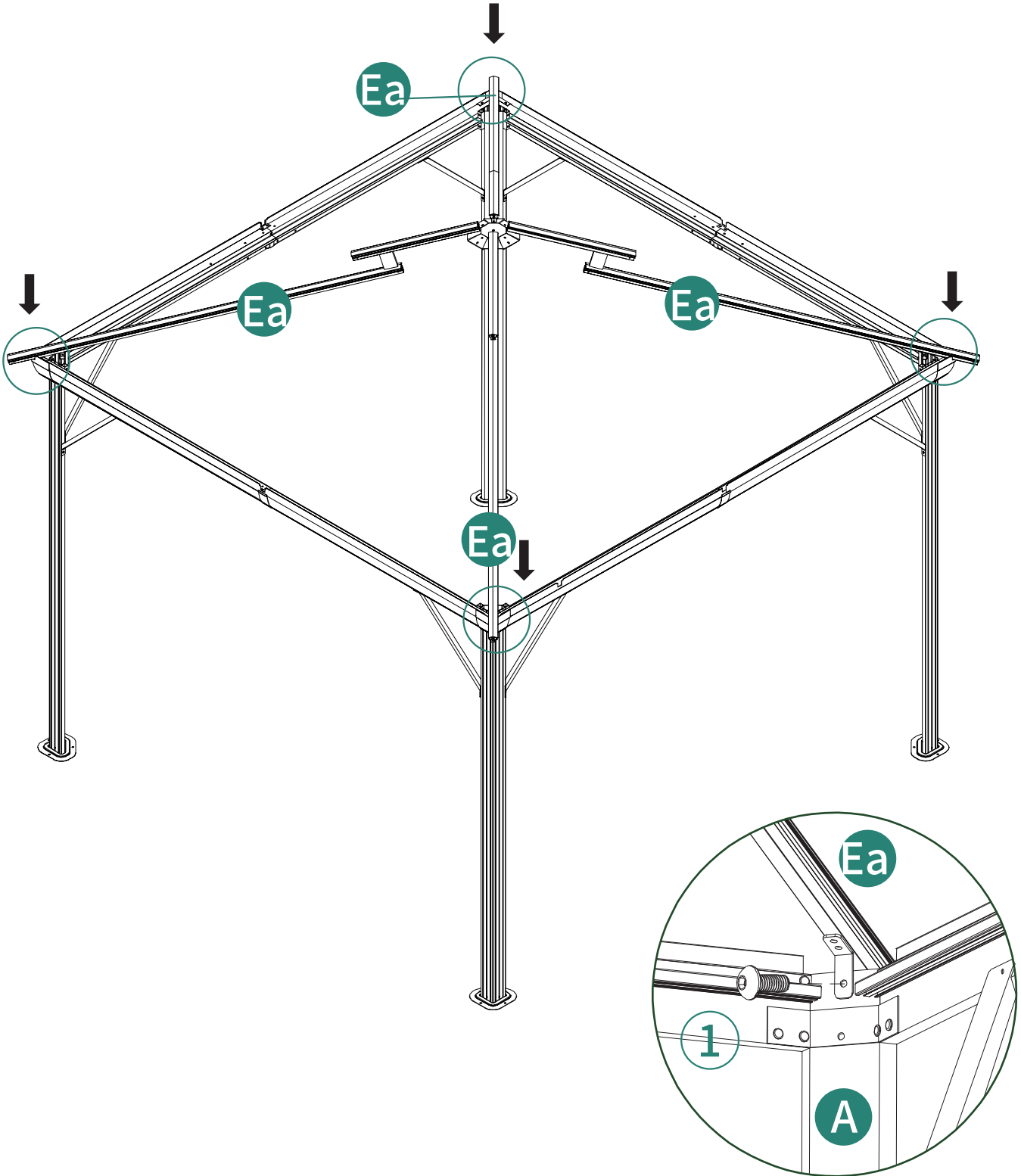

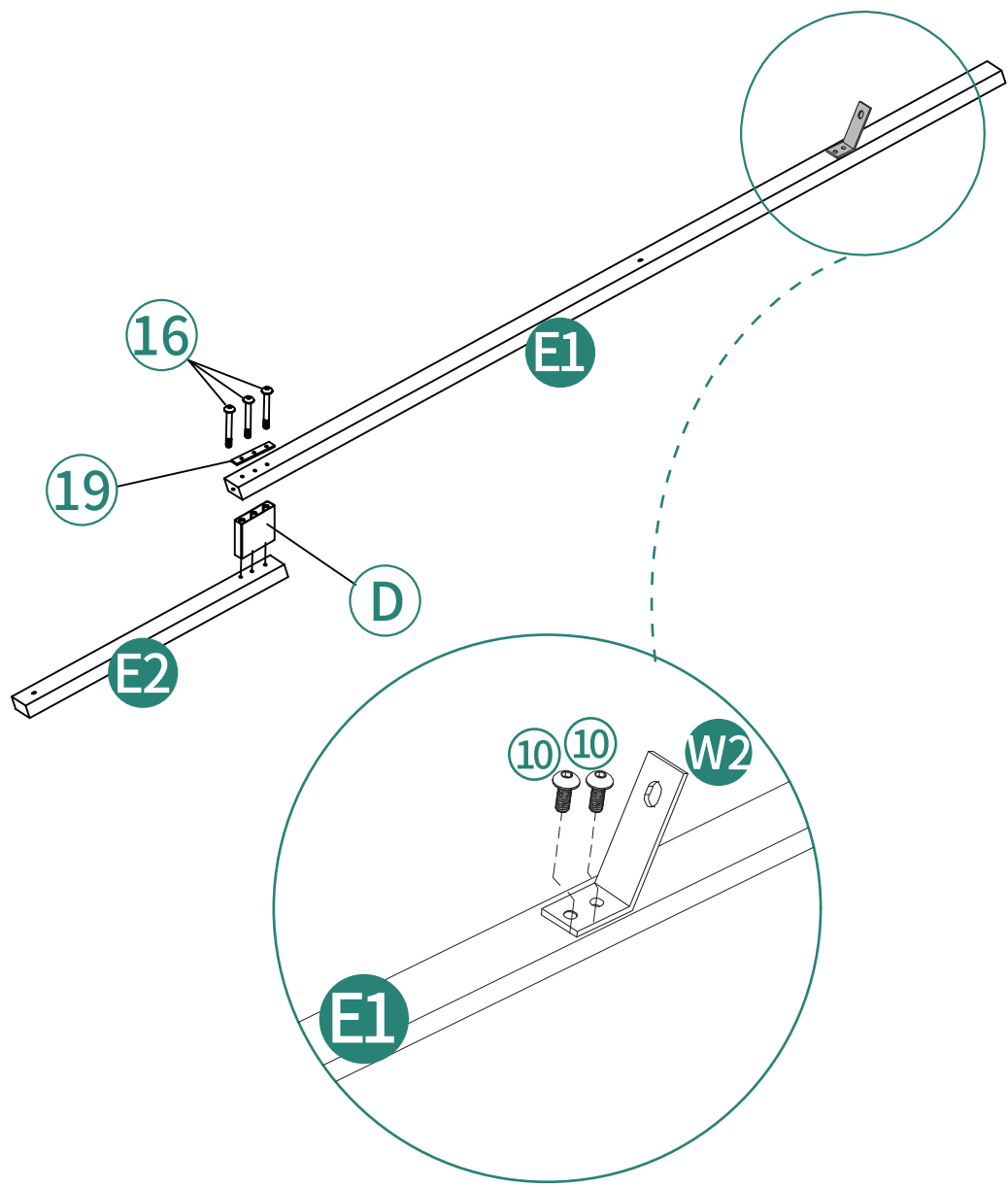
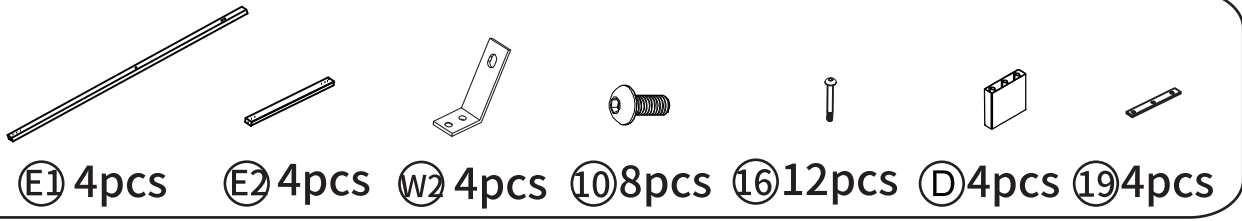

12

X4



13
X4

	
Ⓨ 12pcs	Ⓨ1 12pcs

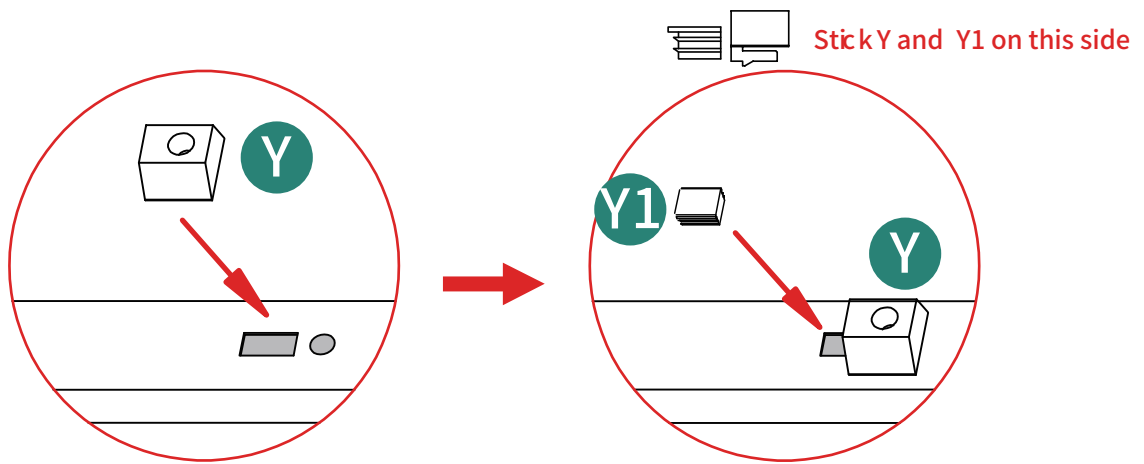
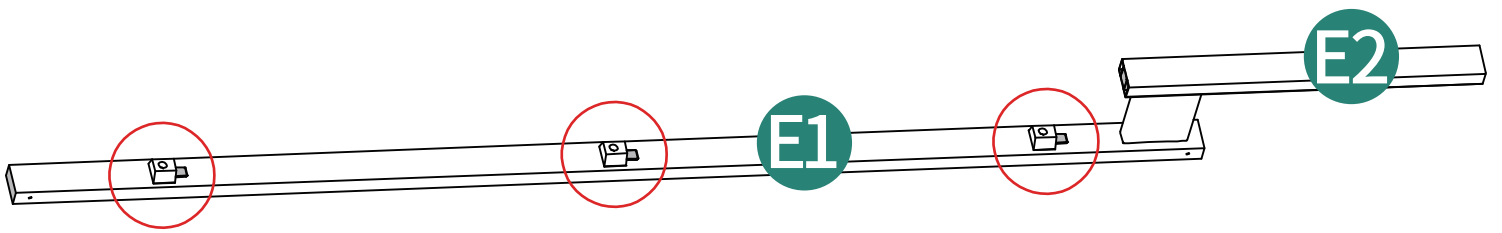

14



① 8pcs

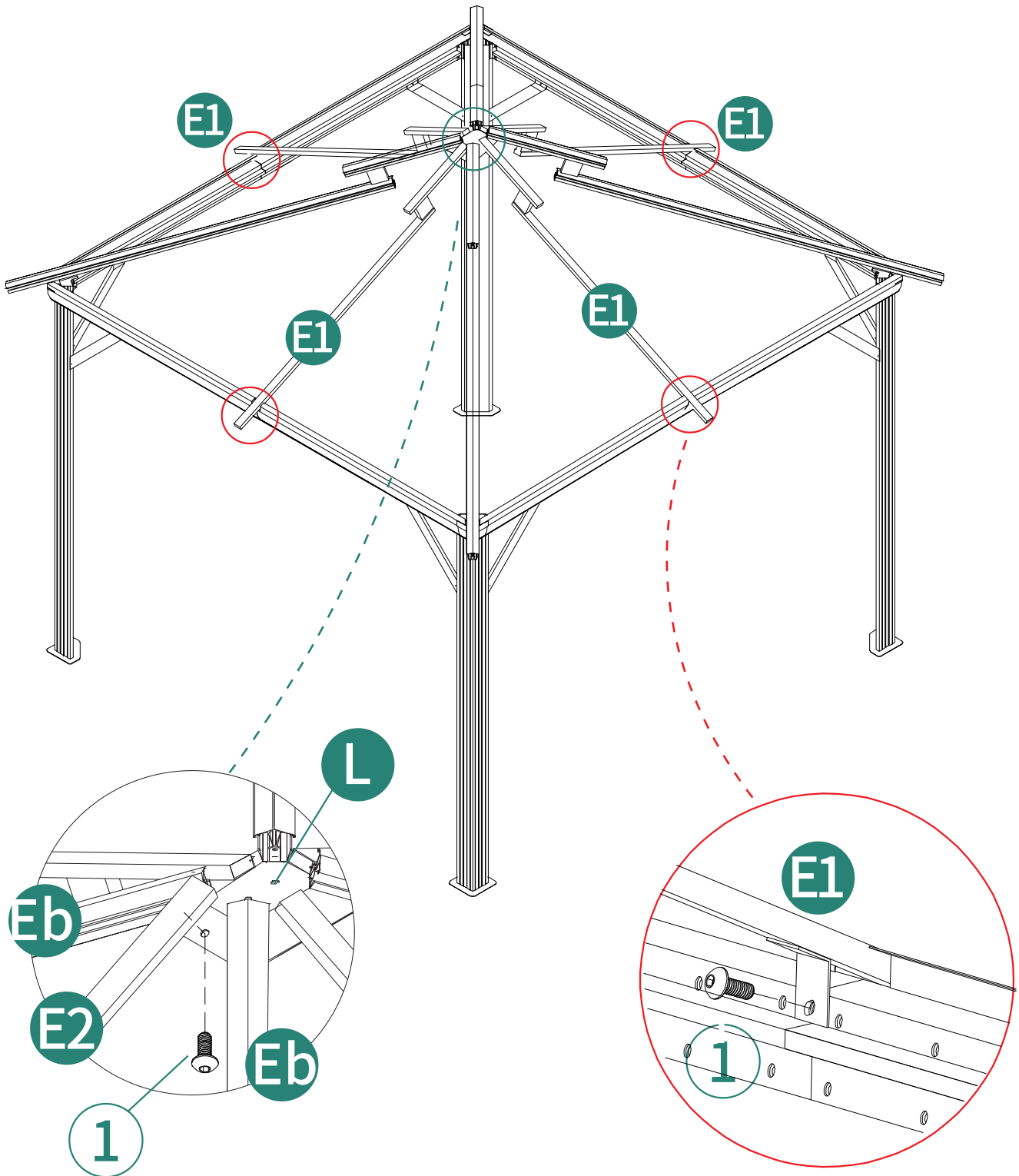

15

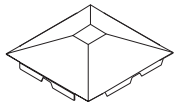

Ⓜ1pc



③1pc

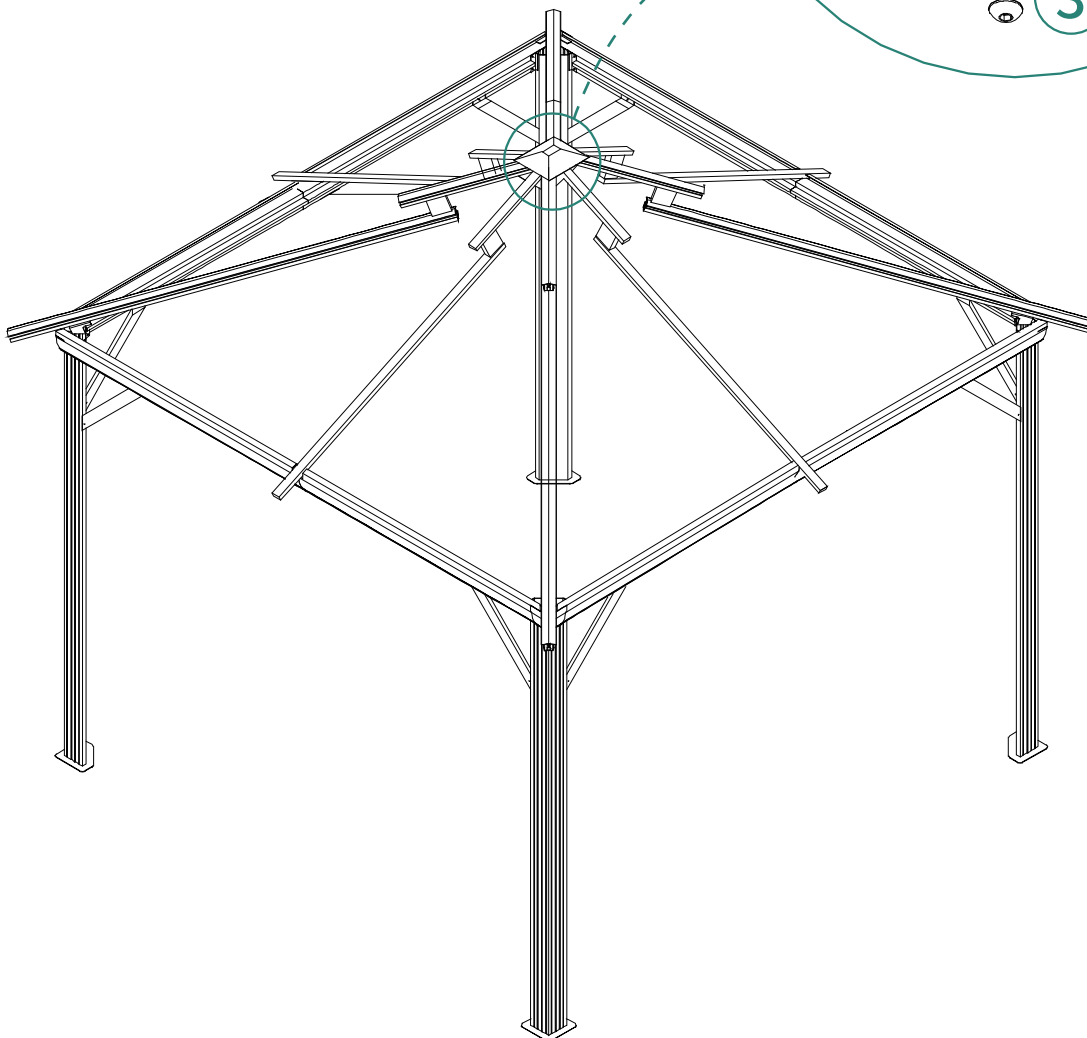
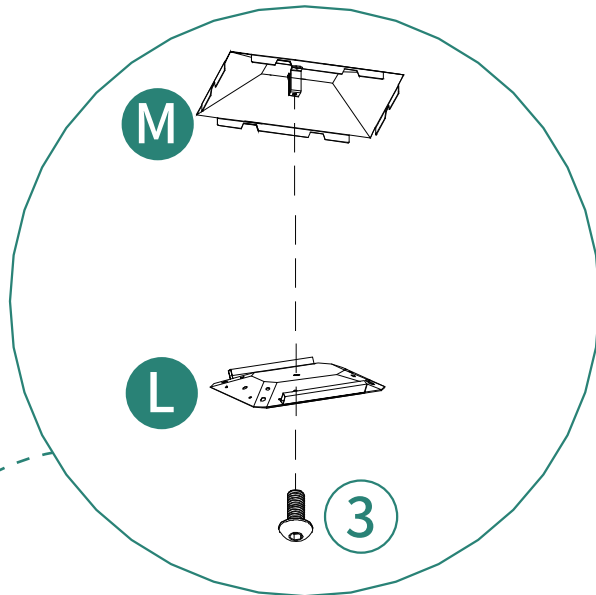

16

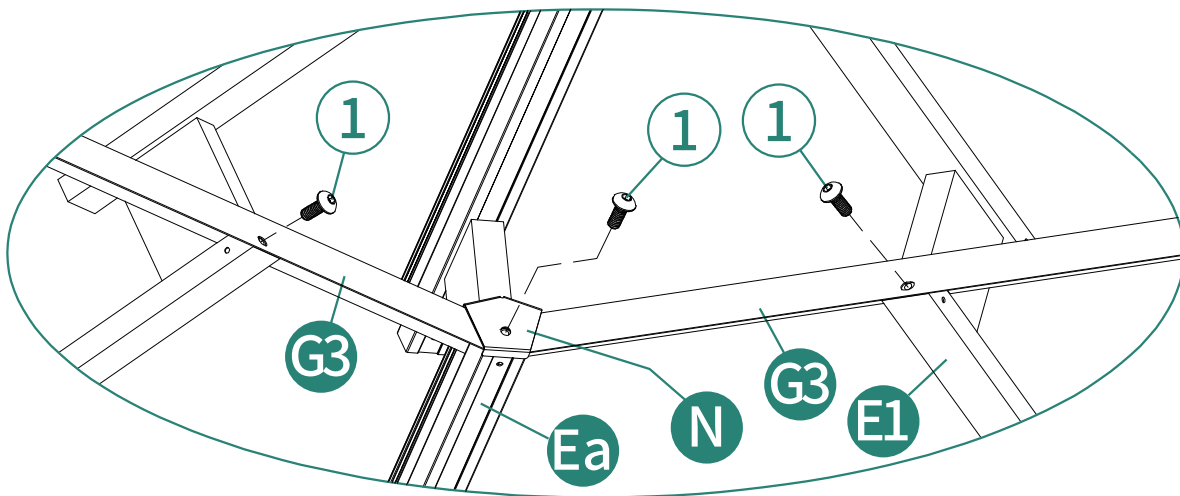
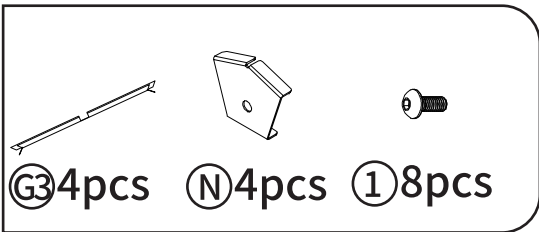

Do not tighten the screw 1 before completing step 22 .
It's view from the bottom inside gazebo.

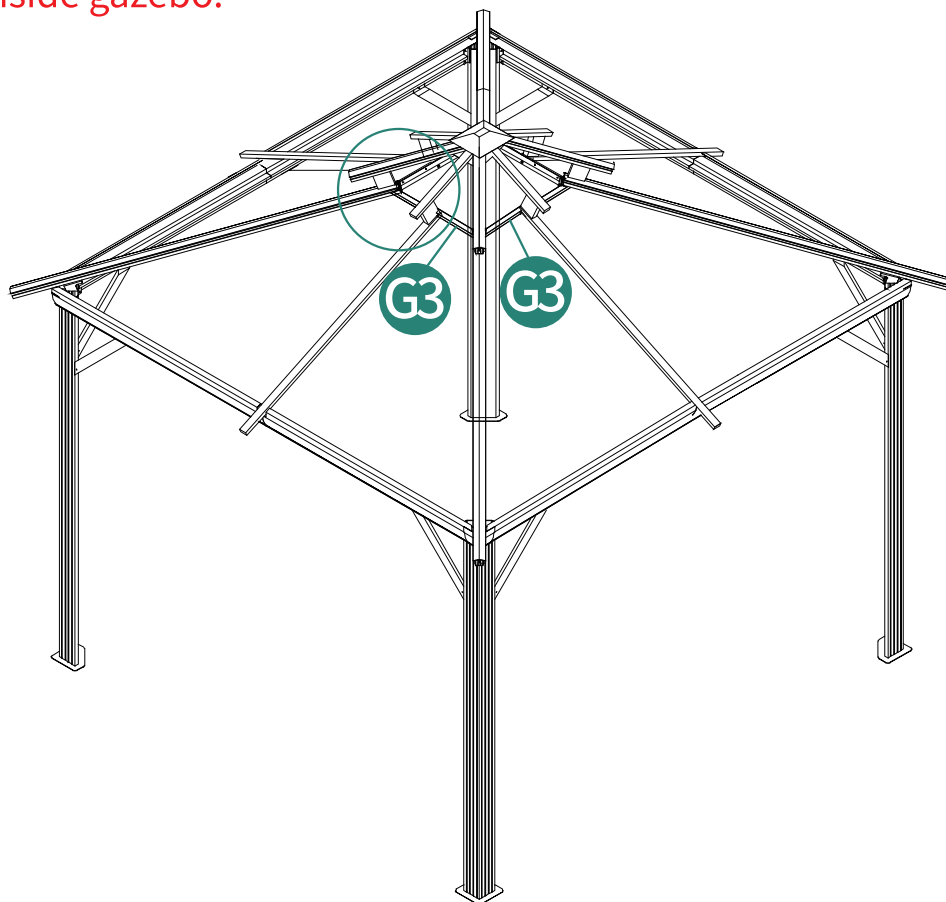

17

X4

Q1 4pcs Q2 4pcs Q3 4pcs Q4 4pcs Q5 4pcs Q6 4pcs

S 4pcs Sa 4pcs

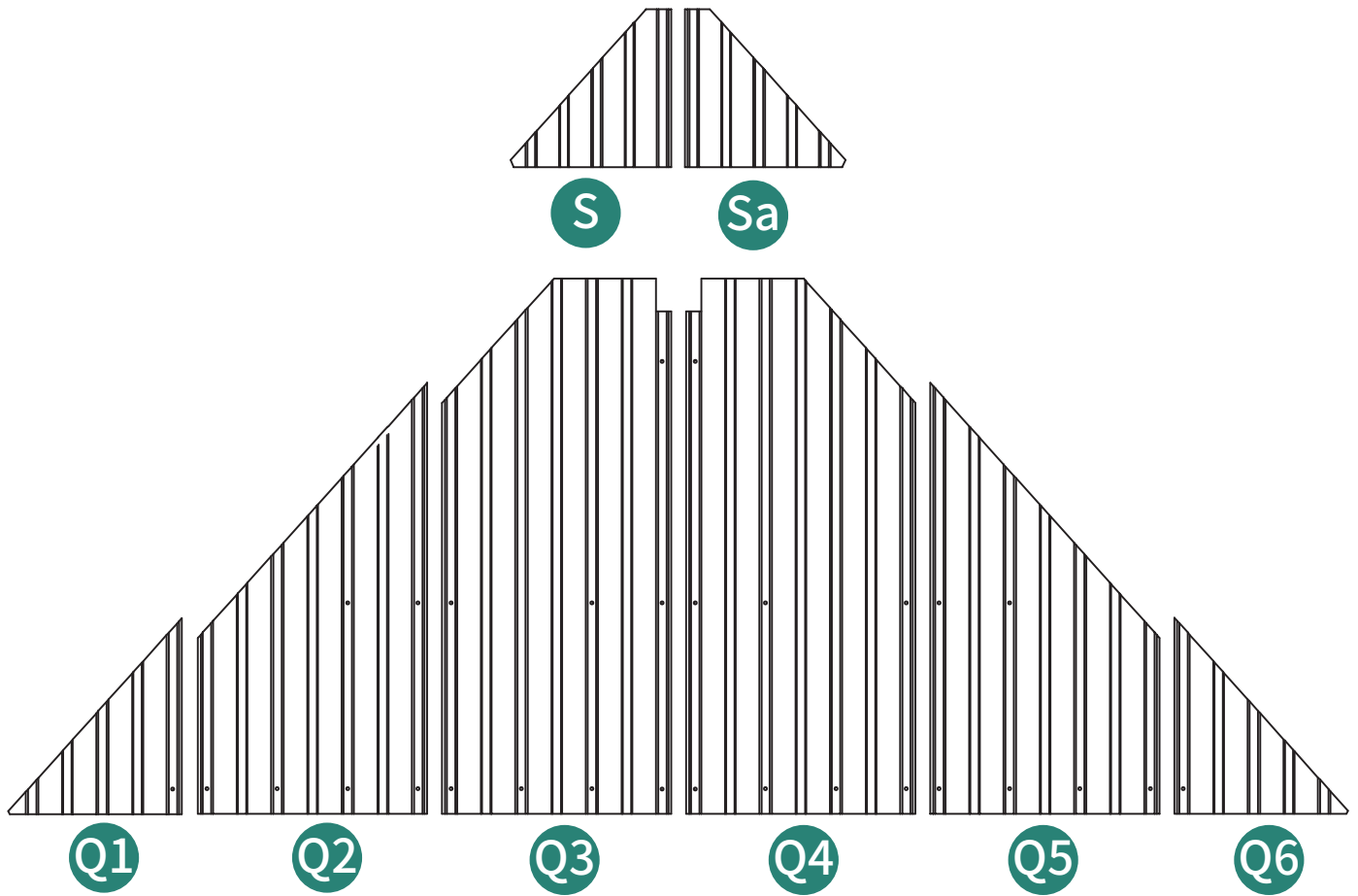

18

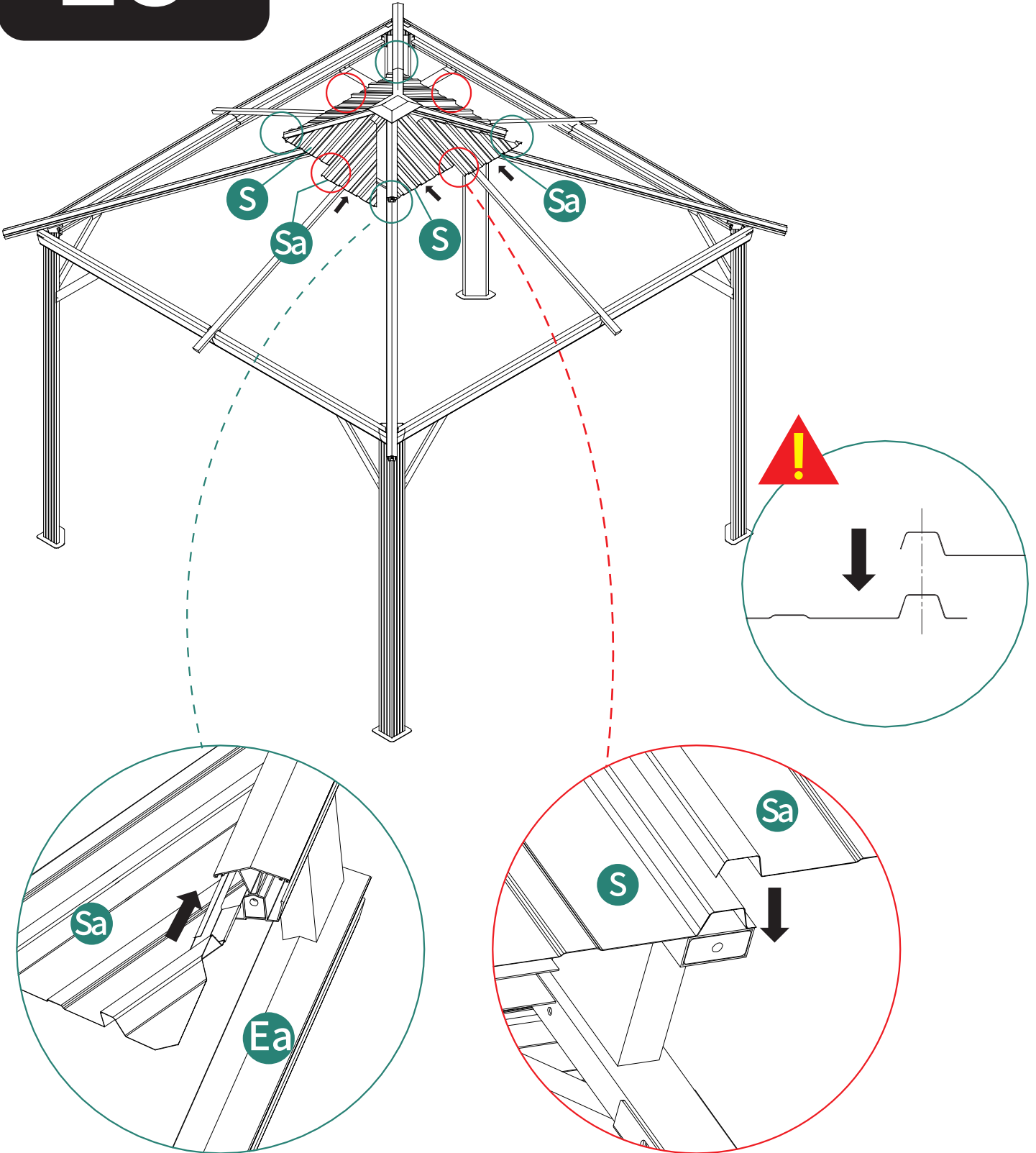

19



G14pcs



N4pcs



18pcs

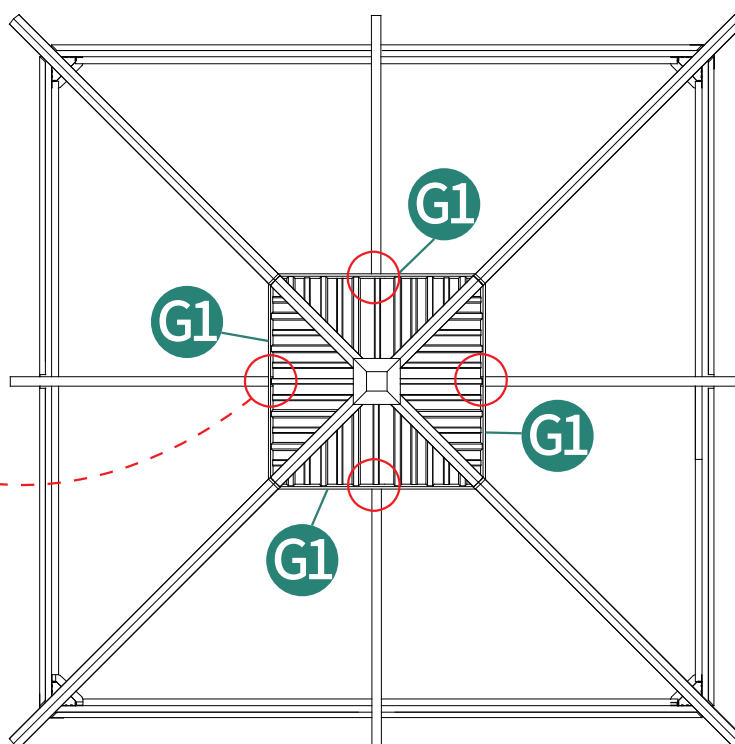
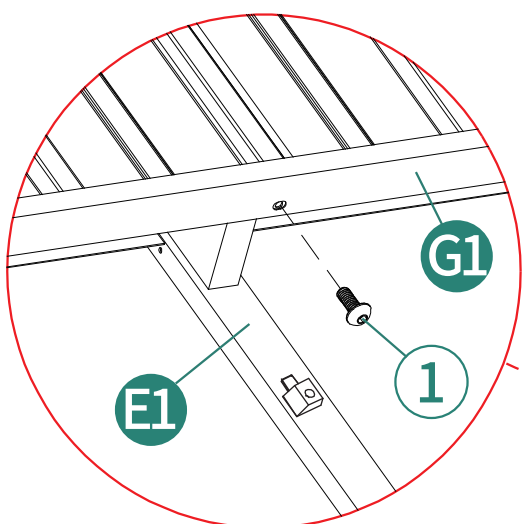
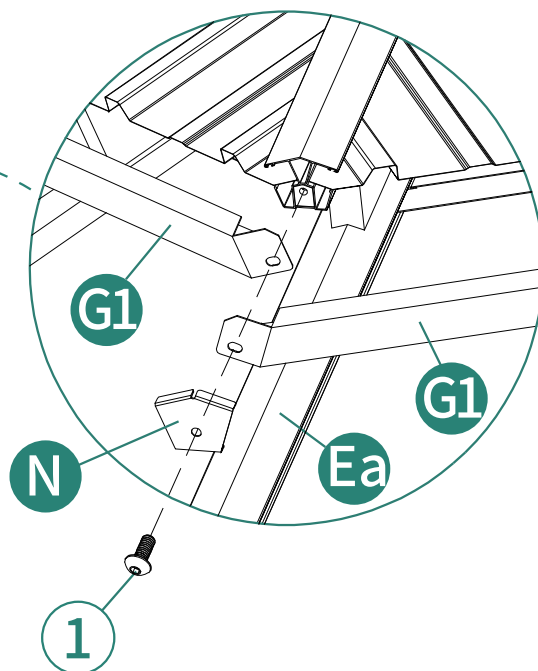
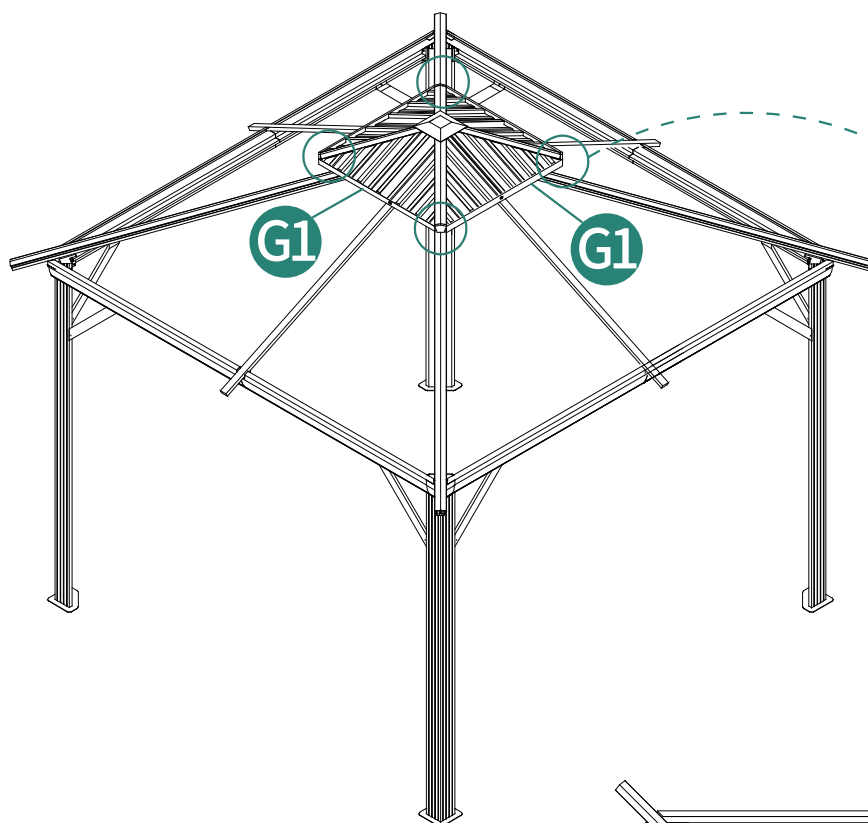

20
X4

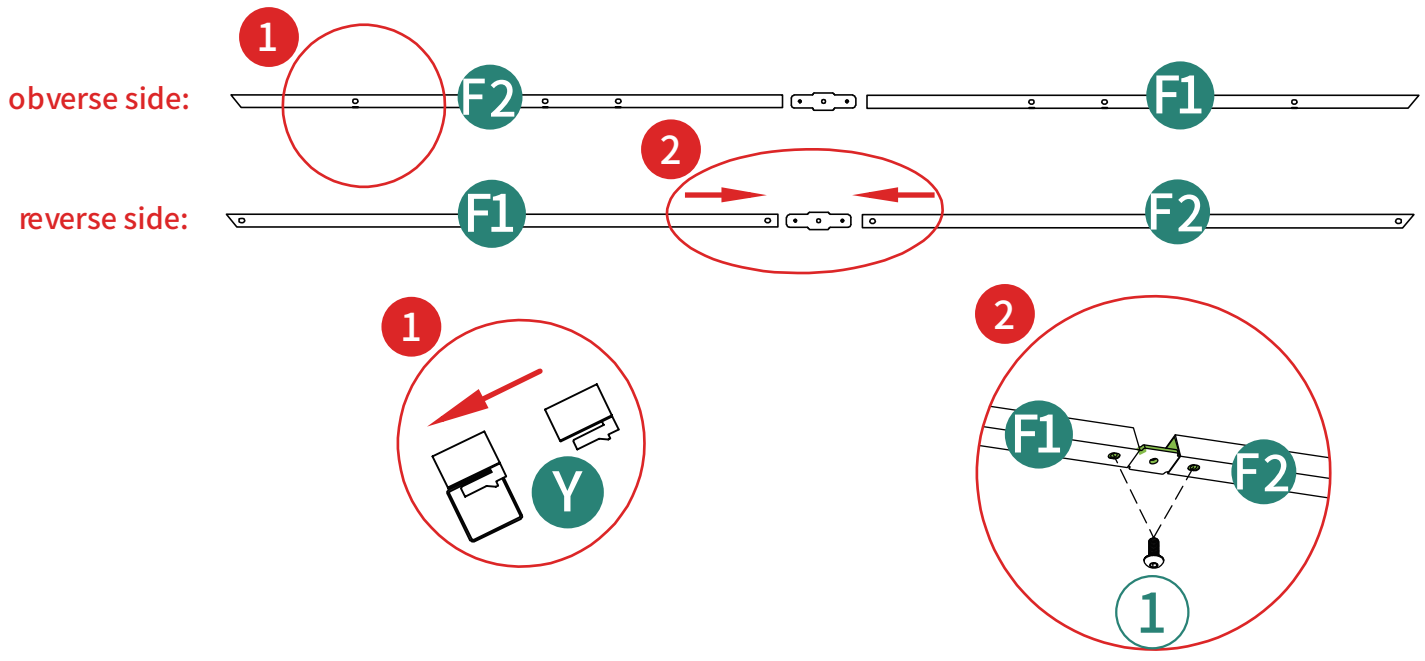
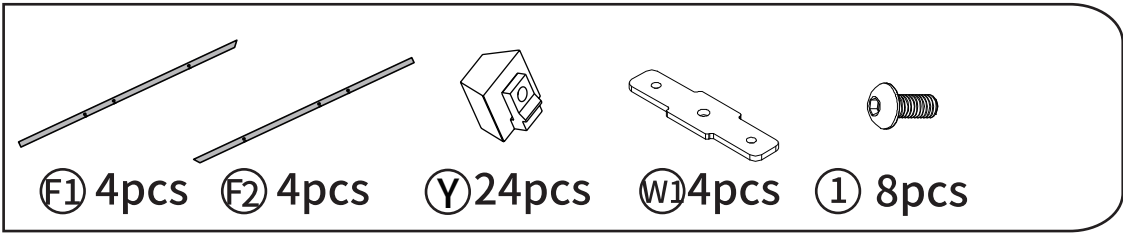

21

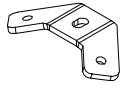

W 4pcs



1 16pcs

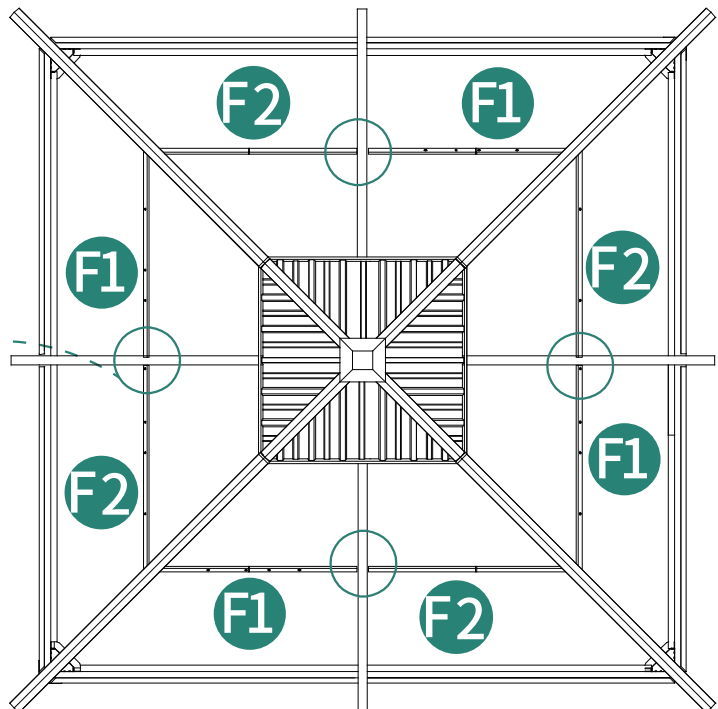
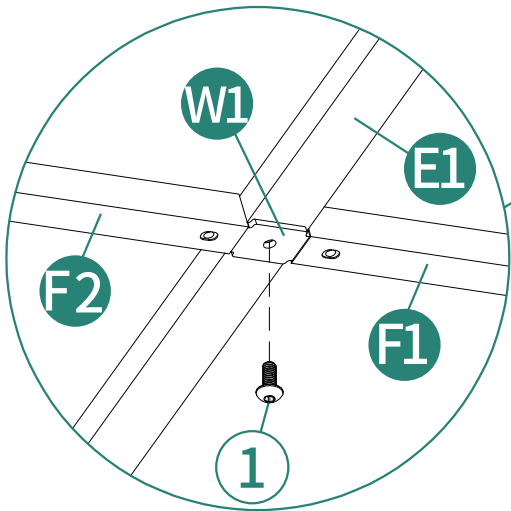
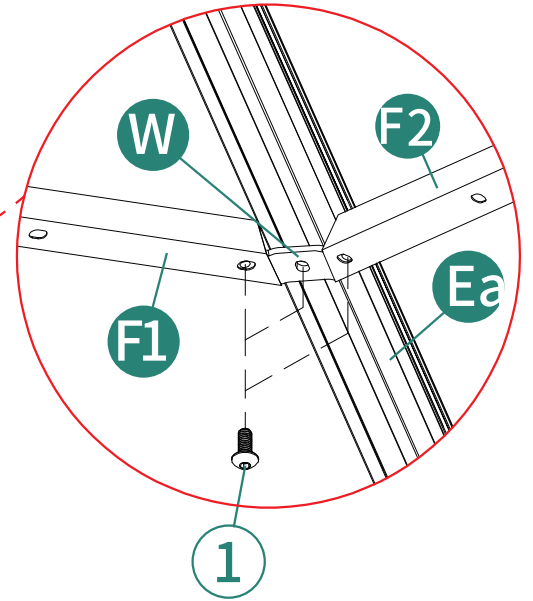
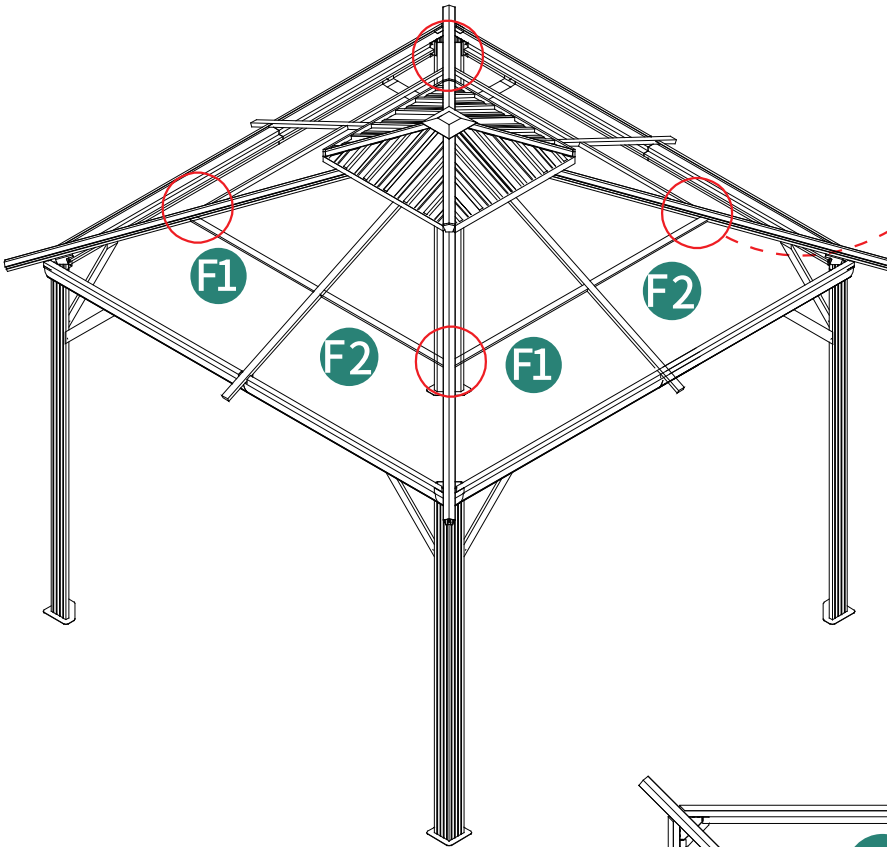

22



Ⓟ V1 2pcs



Ⓟ V2 2pcs



Ⓟ 5 8pcs

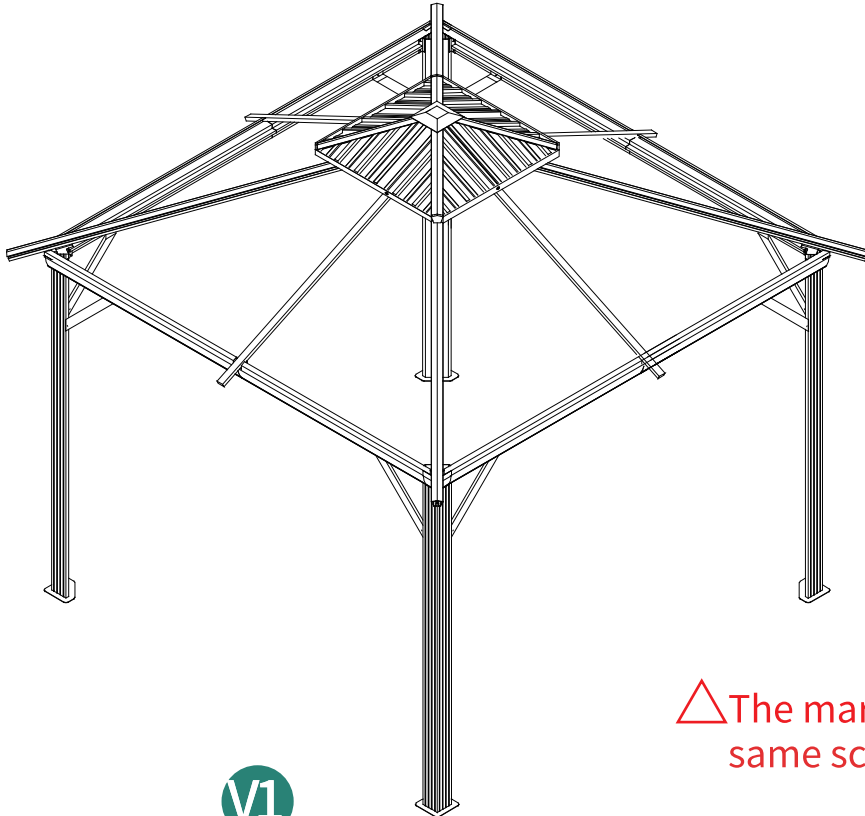

△ The marked parts use the same screws as in step 16.

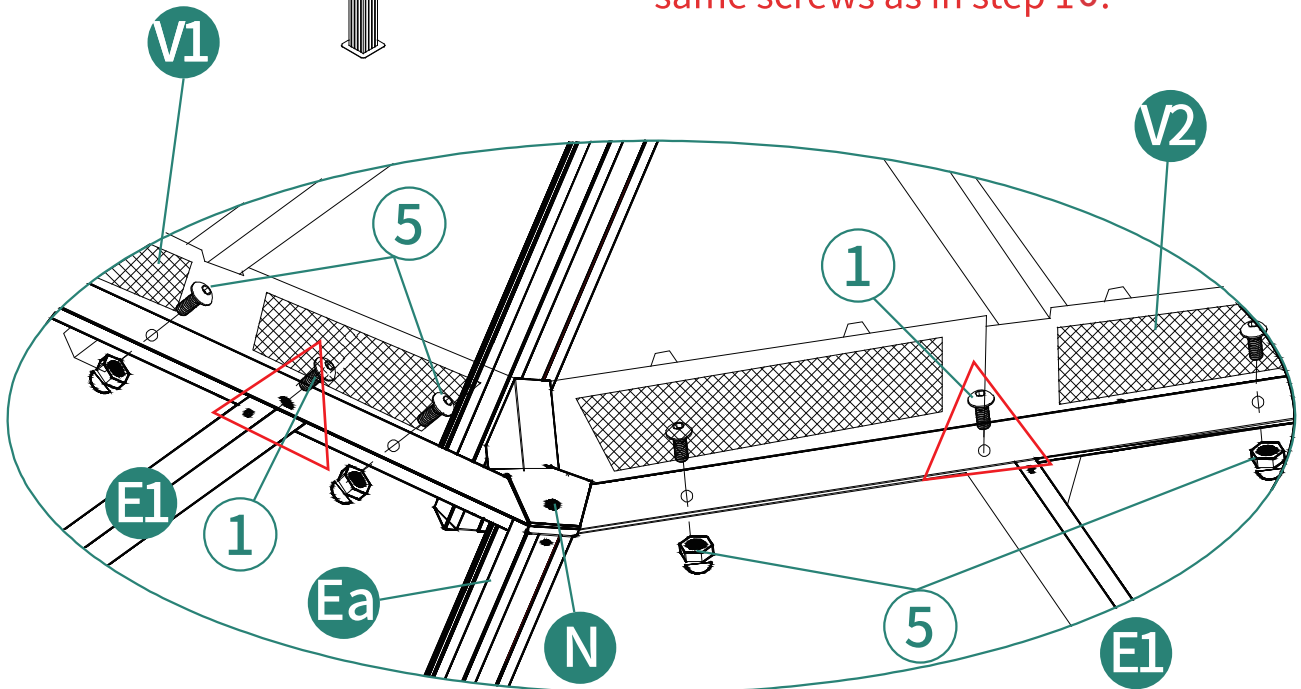

It's view from the bottom inside gazebo.

23

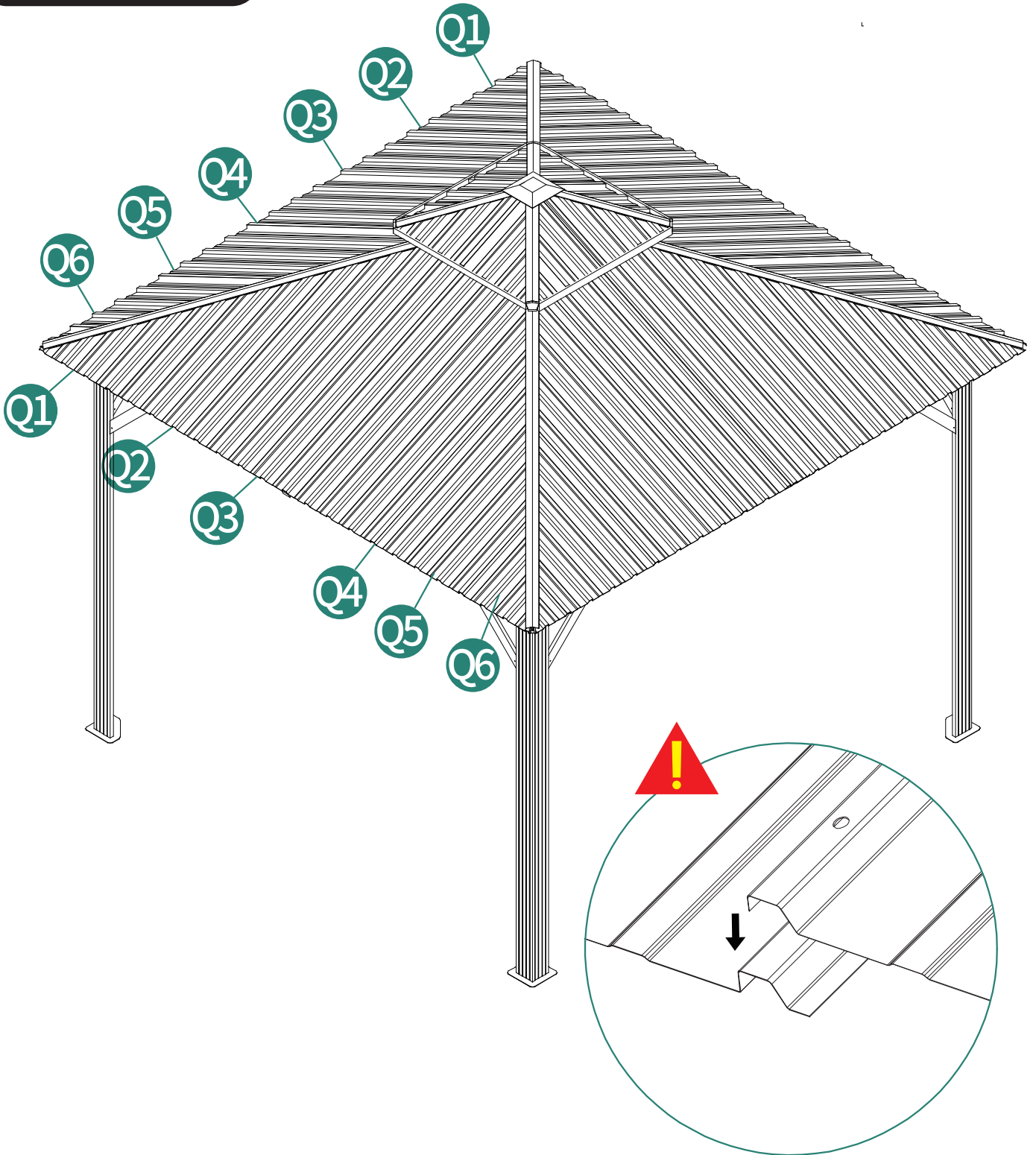



24

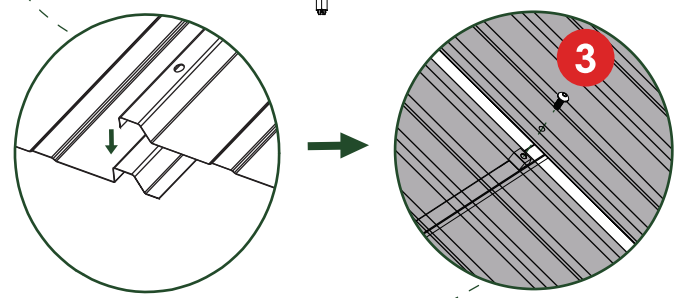
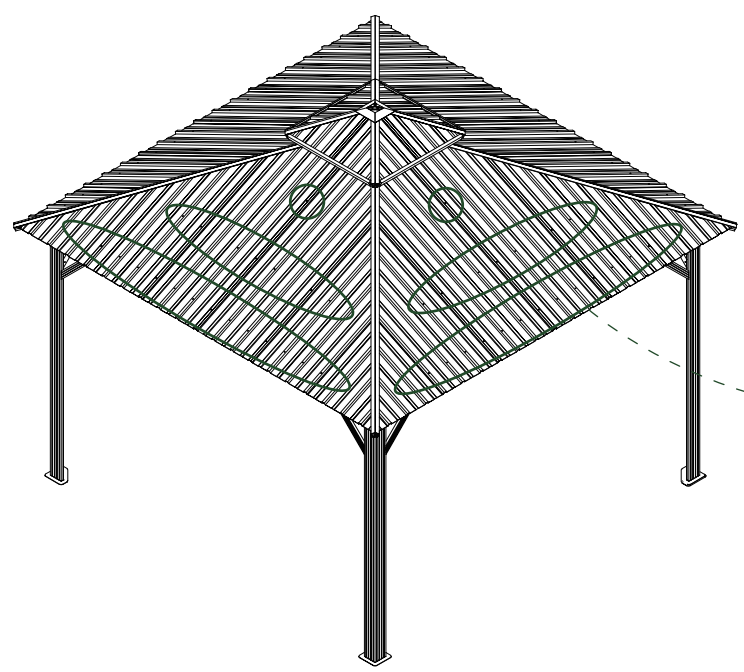
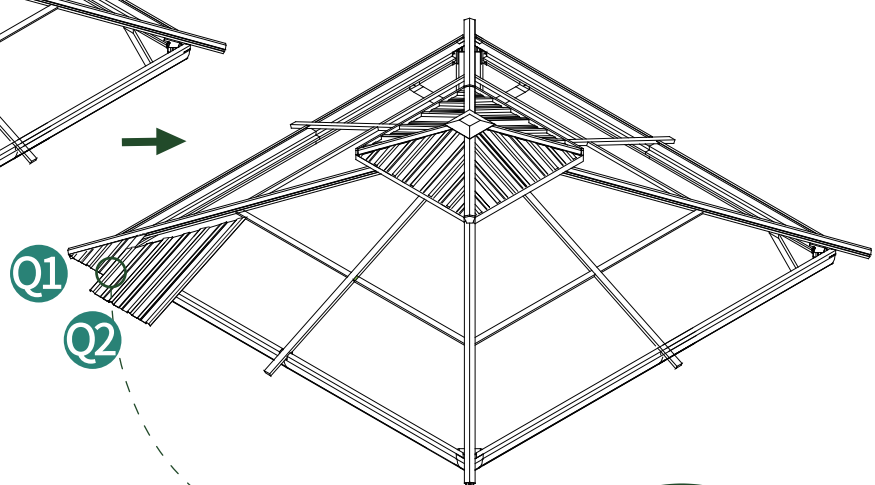
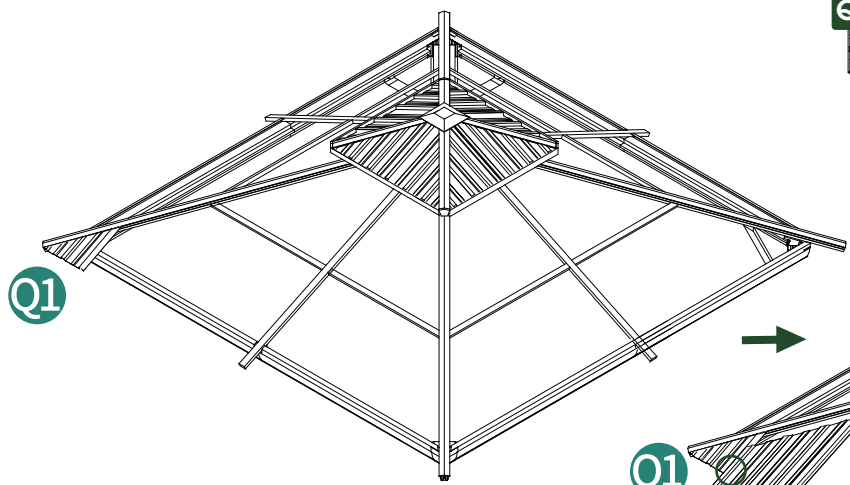
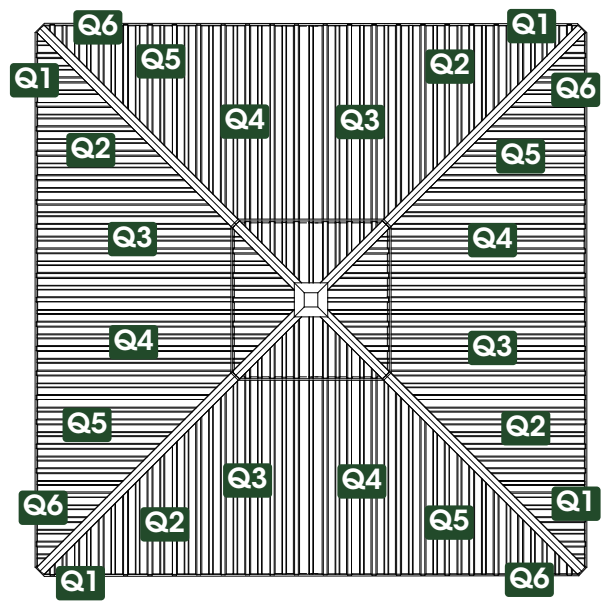

③ 84Pcs

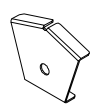
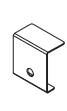
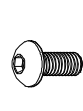

25

-  **G5** 4pcs
-  **G6** 4pcs
-  **N** 4pcs
-  **N1** 4pcs
-  **1** 8pcs

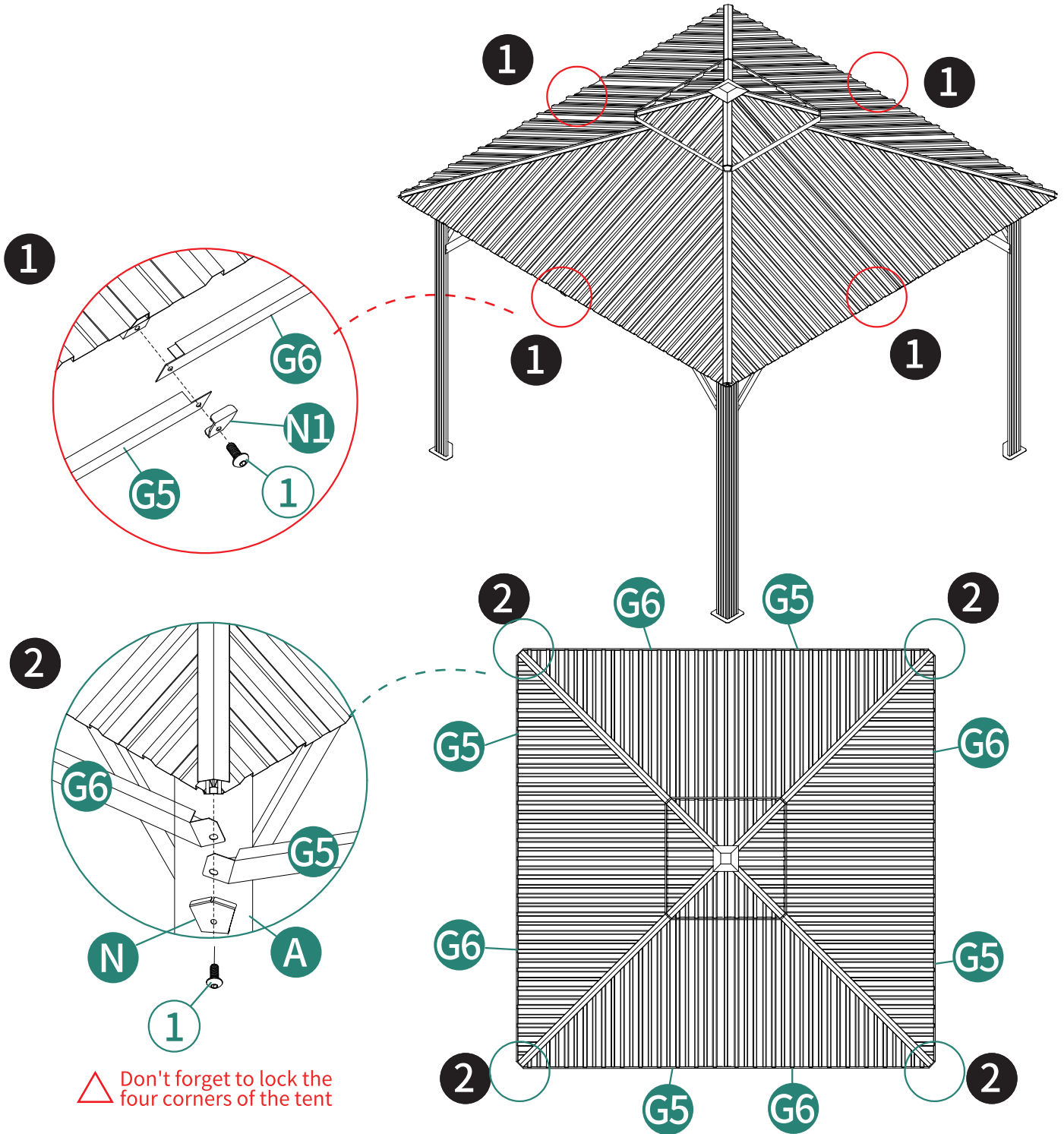

26

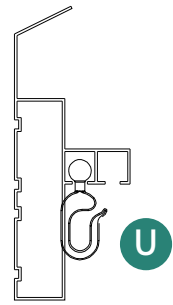
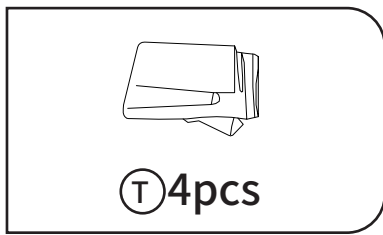

The privacy screen is on the outside, while the netting is on the inside.

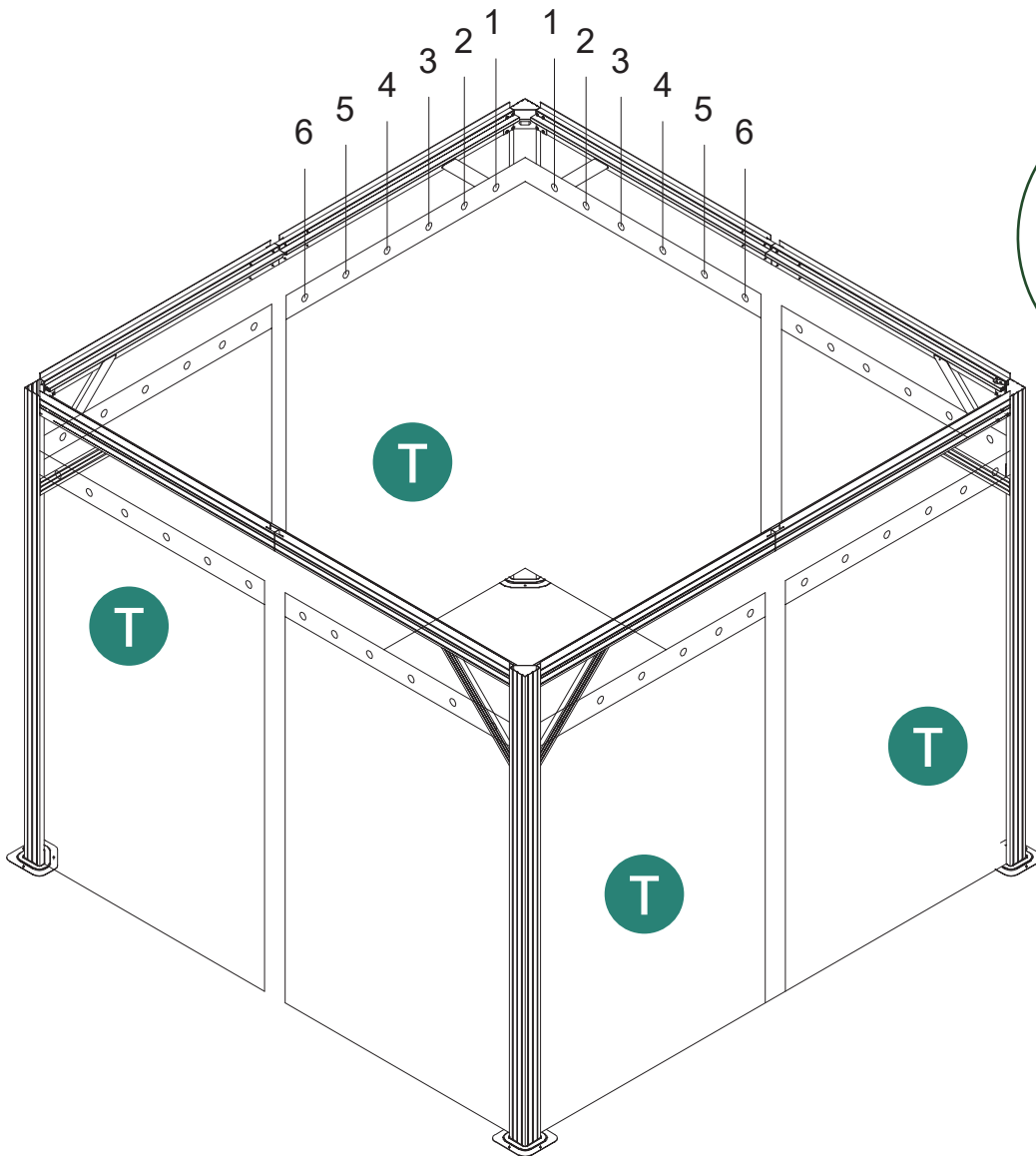
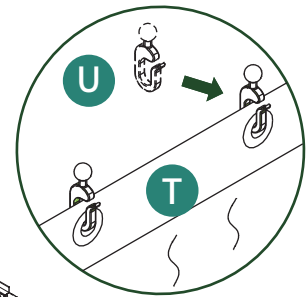

27

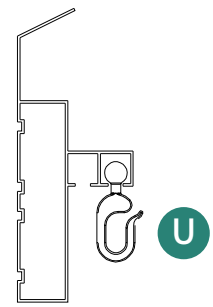
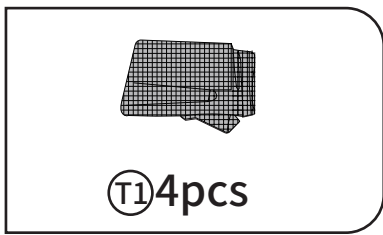

The privacy screen is on the outside, while the netting is on the inside.

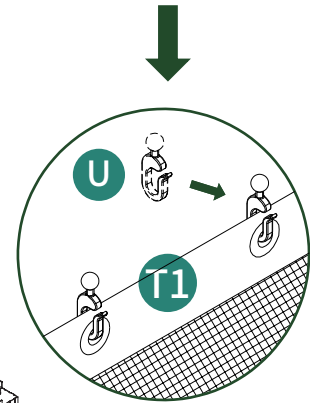
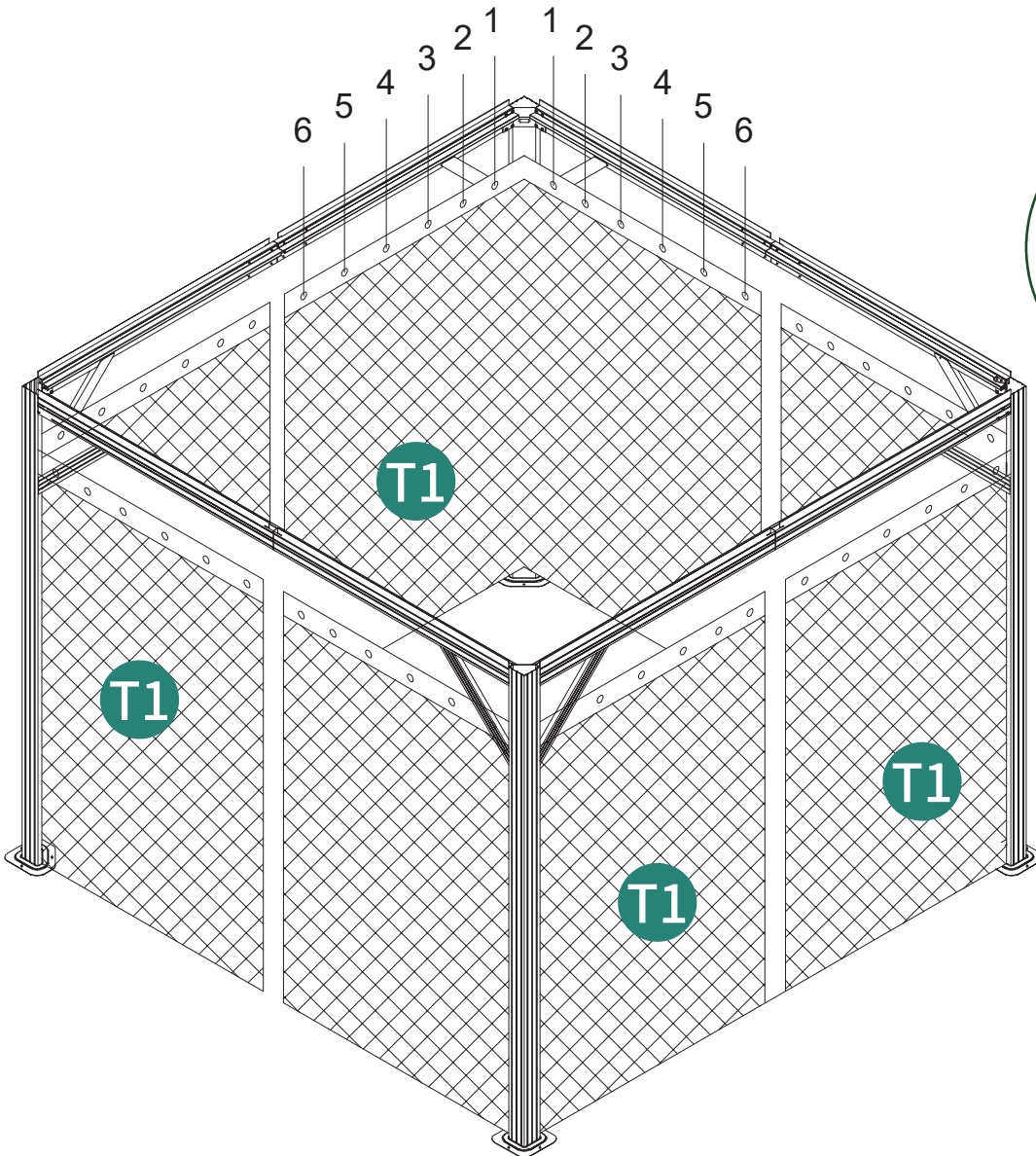

28

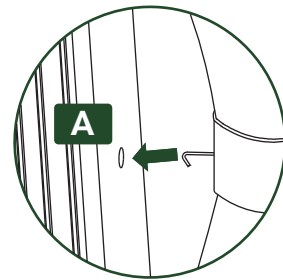
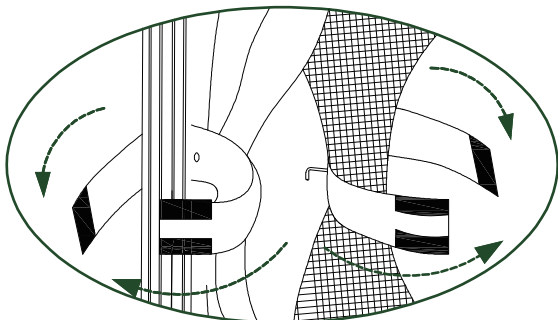
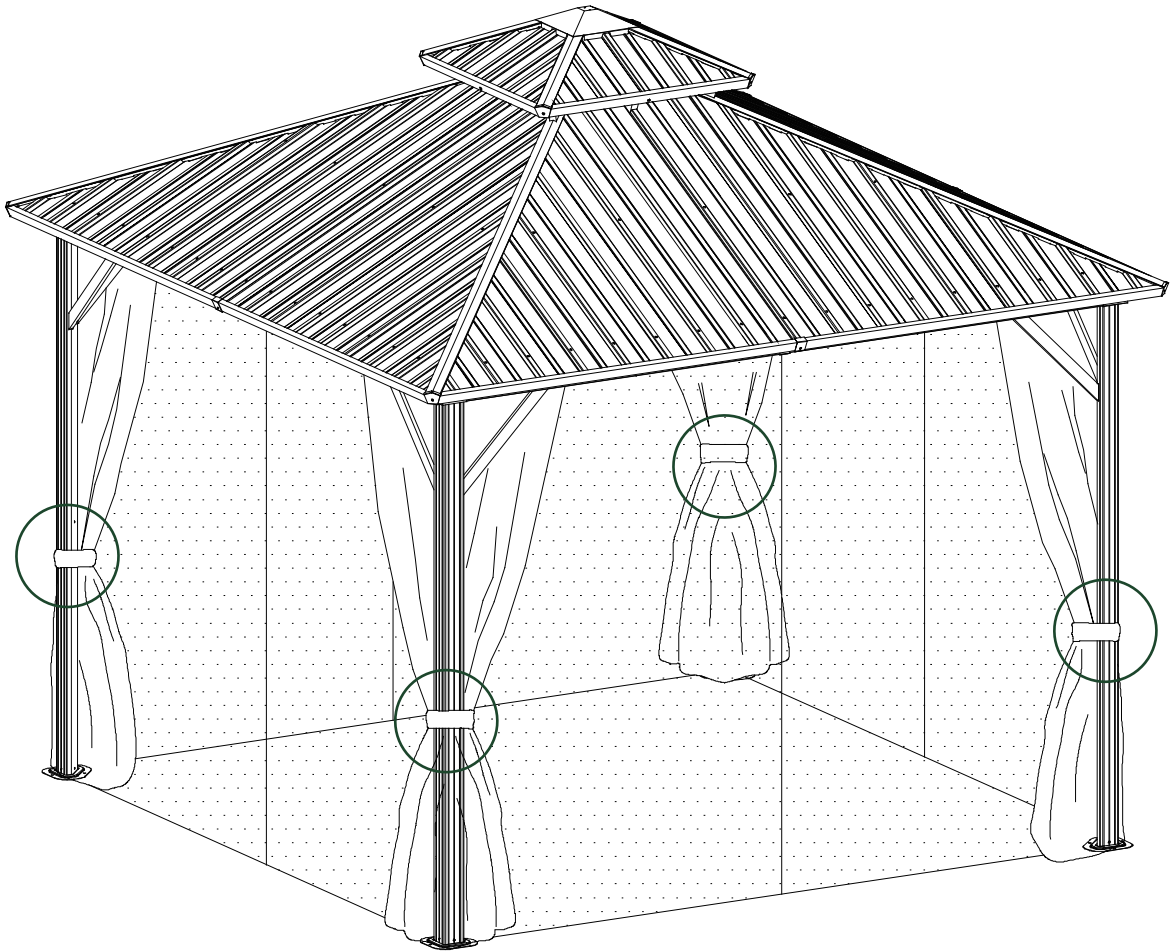

Hang the hook attached to the netting on part "A".

29

⑨ 12 pcs ⑭ 12 pcs

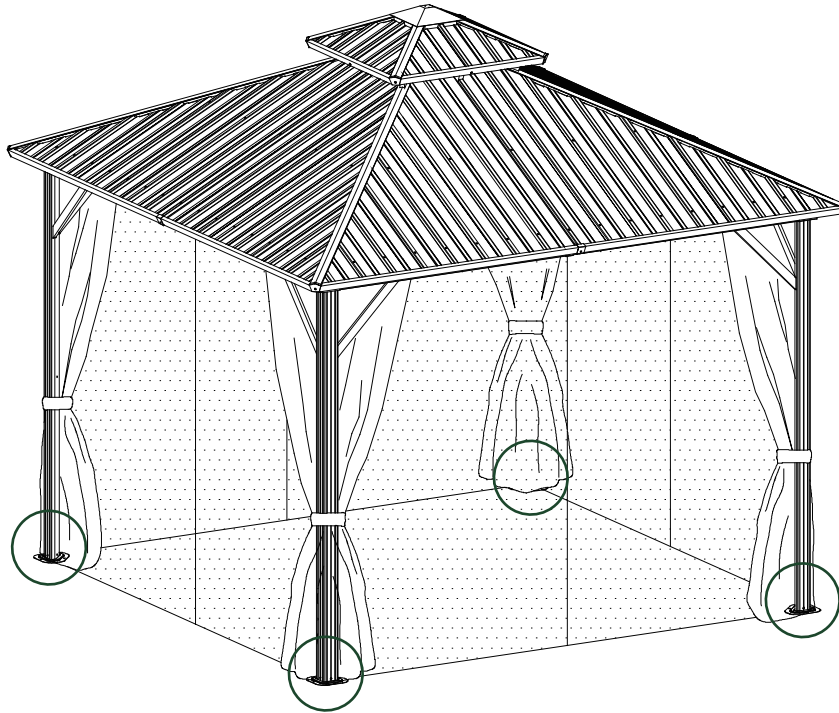

1. The product must be installed on a solid base, such as cement or a floor, to prevent damage from strong winds and potential property or health risks.

2. If the product cannot be securely fixed, you must detach and store it properly before heavy winds occur.

3. The manufacturer will not be liable for any losses or damages if these instructions and recommendations are not followed.

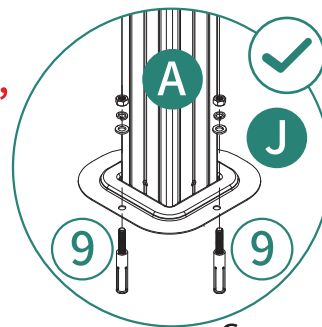

Cement surfaces

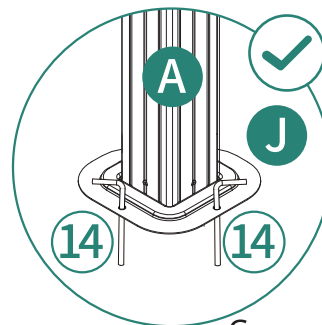
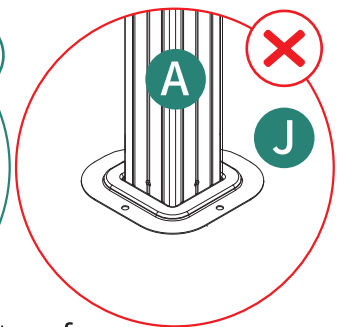

Grassy surfaces

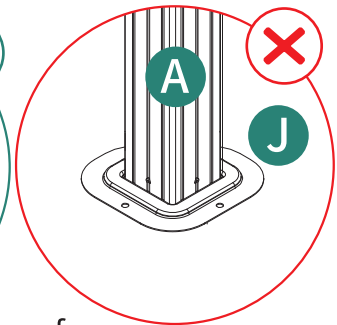

HELP CENTER



Inquiry



Assembly issue



Missing parts

If you encounter any difficulties during assembly, please contact us.

Wenn Sie während der Montage auf Schwierigkeiten stoßen, kontaktieren Sie uns bitte.

Si vous rencontrez des difficultés lors du montage, veuillez nous contacter.

Se incontri difficoltà durante il montaggio, ti preghiamo di contattarci.

Si encuentras alguna dificultad durante el ensamblaje, por favor contáctanos.

DISCLAIMER

Manufacturer and seller expressly disclaim any and all liability for personal injury, property damage or loss, whether direct, indirect, or incidental, resulting from the incorrect attachment, improper use, inadequate maintenance, unapproved modification, or neglect of this product.

Der Hersteller und Verkäufer lehnen ausdrücklich jegliche Haftung für Personenschäden, Sachschäden oder Verluste ab, egal ob direkt, indirekt oder zufällig, die durch falsche Anbringung, unsachgemäßen Gebrauch, unzureichende Wartung, nicht genehmigte Änderungen oder Vernachlässigung dieses Produkts entstehen.

El fabricante y vendedor renuncian expresamente a toda responsabilidad por lesiones personales, daños materiales o pérdidas, ya sean directos, indirectos o incidentales, derivados de la incorrecta colocación, uso inadecuado, mantenimiento insuficiente, modificación no aprobada o negligencia de este producto.

Il produttore e il venditore declinano espressamente ogni responsabilità per lesioni personali, danni materiali o perdite, dirette, indirette o incidentali, derivanti dall'errato fissaggio, uso improprio, manutenzione inadeguata, modifica non autorizzata o negligenza di questo prodotto. Le fabricant et le vendeur déclinent expressément toute responsabilité en cas de blessures corporelles, de dommages matériels ou de pertes, qu'ils soient directs, indirects ou accessoires, résultant de la fixation incorrecte, de l'utilisation inappropriée, de l'entretien insuffisant, de la modification non approuvée ou de la négligence de ce produit.