

SFU4302MCX



Category	Compact 24"
Product family	Oven
Power supply	Electrical
Power supply	Electricity
Cooking method	Combi Microwave
Cleaning system	VaporClean
EAN code	8017709250775



Aesthetic

Aesthetics	Classic	Silkscreen type	Symbols
Color	Stainless steel	Door	With 2 horizontal fascias
Finishing	Fingerprint-proof	Handle	Classic
Design	Flat	Handle color	Stainless steel
Material	Stainless steel	Logo	Embossed
Stainless steel type	Brushed	Control knobs	Classic
Glass type	Eclipse	Controls color	Stainless steel effect
Silkscreen color	Black		









Controls

Display technology	LCD	No. of controls	2
Controls setting	Control knobs		





Programs / Functions

No. of cooking functions	13
Automatic programmes	20





Traditional cooking functions

-  Static
-  Fan-assisted
-  True European convection
-  Turbo
-  Eco
-  Large grill
-  Fan grill (large)
-  Convection bottom

Microwave functions

-  Microwave
-  Fan-assisted
-  True European convection
-  Microwave + Grill
-  Warming and re-generation

Other functions

-  Defrost by time
-  Defrost by weight
-  Proof
-  Sabbath

Cleaning functions

-  Vapor Clean

Options



Time-setting options Delayed start and automatic shut-off when cooking ends

Minute minder Timer Yes
1

Child safety lock Yes

Other options Keep-warm, Eco light, Quick start

Showroom mode Yes

Technical Features



Minimum Temperature 86 °F

Maximum temperature 482 °F

No. of shelves 3

No. of lights 2

Lighting Halogen

Light power 40 W

Light on when door is open Yes

Lower heating element power 1000 W

Grill element - power 2000 W

Door opening Standard opening

Door Cool-touch door

Total no. of door glasses 3

Microwave stops when door is opened Yes

Soft Close Yes

Cooling system Tangential

Cooling duct Single

Temperature control Electronic

Cavity material EverClean enamel

Microwave screen protection Yes

Circular heating element 1400 W
- Power

Heating elements stop Yes
when door is opened

Performance / Energy Label



Volume of the cavity 1.41 cu. ft.
Number of cavities 1

Microwave effective power 1000 W

Accessories Included



Rack with back stop 1
Insert grid 1

Glass tray 1
Telescopic Guide rails, partial Extraction 1

Electrical Connection

Voltage 230 V
Nominal power 3400 W
Voltage 120/208 V

Current 13 A
Frequency 60 Hz
Power cord length 45 1/4 "

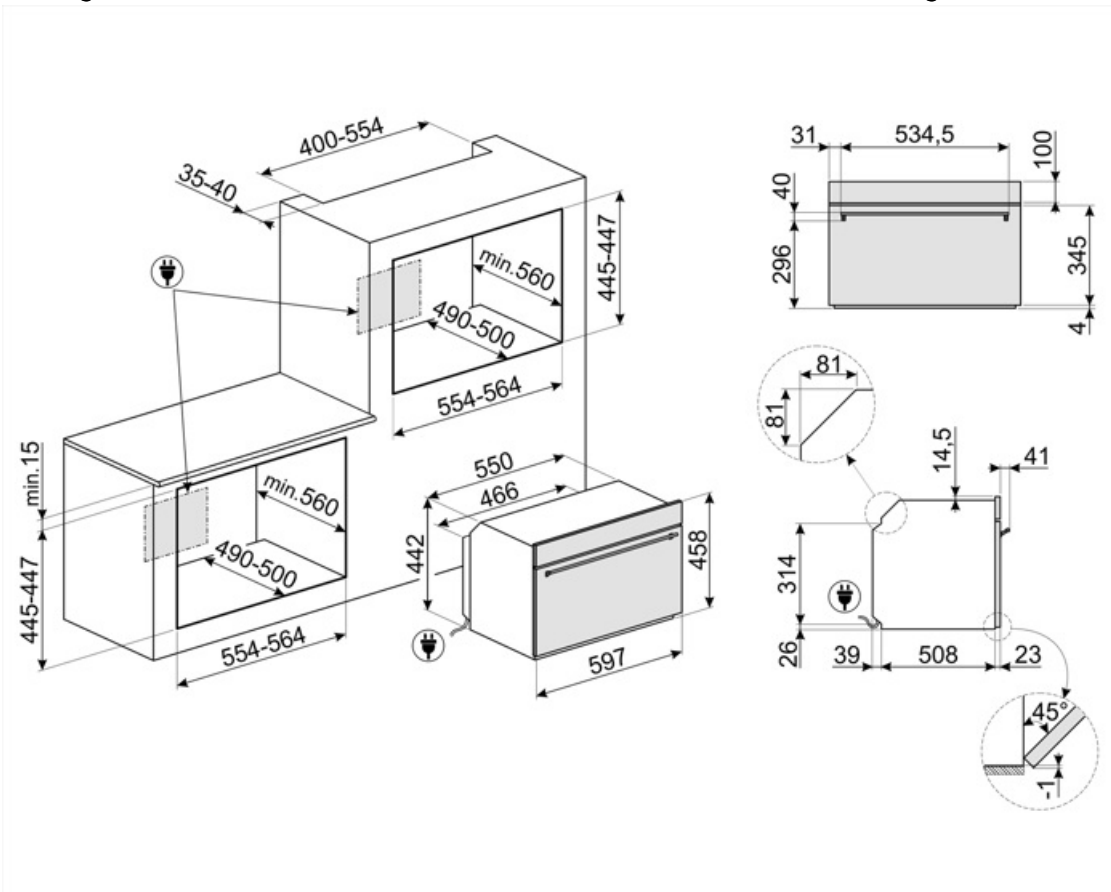

Compatible Accessories



BN620-1

Enamelled tray, 20mm deep



BN640

Enamelled tray, 40mm deep



GTP

****Partial-extension telescopic guides****
Length: 14" Extraction: 11 1/4" Material:
Stainless steel AISI 430 polished



GTT

****Total-extension telescopic guides****
Length: 14" Extraction: 16.5" Material:
Stainless steel AISI 430 polished



KIT330X

30" Trim kit for Classic compact ovens



KIT370X

27" Trim kit for Classic compact ovens



PALPZ

















Pizza shovel with fold away handle
width: 315mm length : 325mm



PR3845X

Antifingerprint stainless steel. Cover
for furniture in column installation of
more ovens

Symbols glossary

 <p>Child lock: some models are fitted with a device to lock the programme/cycle so it cannot be accidentally changed.</p>	
 <p>Combination microwave: This oven allows to combine two different ways of cooking (Traditional with microwaves). Combined ovens increase cooking opportunities, while providing maximum flexibility of household appliances.</p>	 <p>Air cooling system: to ensure a safe surface temperatures.</p>
 <p>Defrost by time: with this function the time of thawing of foods are determined automatically.</p>	 <p>Defrost by weight: With this function the defrosting time is determined</p>
 <p>Triple glazed doors: Number of glazed doors.</p>	 <p>Automatic lighting switches off: for greater energy savings, the lighting switches off automatically after one minute from the start of cooking.</p>
 <p>Electric</p>	 <p>Enamel interior: The enamel interior of all Smeg ovens have a special antacid lining which helps keep the interior clean by reducing the amount of cooking grease adhering to it.</p>
 <p>Fingerprint proof stainless steel: Fingerprint proof stainless steel keeps stainless steel looking as good as new.</p>	 <p>Circogas: In gas ovens the fan distributes the heat quickly and evenly throughout the oven cavity, avoiding flavour transfer when cooking a number of different dishes at the same time. In electric ovens this combination completes cooking more quickly of foods that are ready on the surface, but that require more cooking inside, without further browning.</p>
 <p>Fan with upper and lower elements: The elements combined with the fan aim to provide more uniform heat, a similar method to conventional cooking, so pre-heat is required. Most suitable for items requiring slow cooking methods.</p>	 <p>Upper and lower element only: a traditional cooking method best suited for single items located in the centre of the oven. the top pf the oven will always be hottest. Ideal for roast, fruit cakes, bread etc.</p>
 <p>True European Convection: The combination of the fan and circular heating element around it provides many benefits, including no preheat if cooking time is longer than 20 minutes, no flavor transfer when cooking different foods at the same time, lower energy consumption, and shorter cooking times. Suitable for all types of food preparations.</p>	 <p>ECO: The combination of the grill, fan and lower element is particularly suitable for cooking small quantities of food.</p>

- 

Grill element: Using of grill gives excellent results when cooking meat of medium and small portions, especially when combined with a rotisserie (where possible). Also ideal for cooking sausages and bacon.



Fan with grill element: The fan reduces the fierce heat from the grill, providing an excellent method of grilling various foods, chops, steaks, sausages etc. giving even browning and heat distribution, without drying out the food. The top two levels recommended for use, and the lower part of the oven can be used to keep items warm at the same time, an excellent facility when cooking a grilled breakfast. Half grill (centre portion only) is ideal for small quantities of food.
- 

Microwave: Penetrating straight into the food, microwaves cook very quickly and with considerable energy savings. Suitable for cooking without fat, they are also able to thaw and heat food without altering its original appearance and aroma. The microwave function can also be combined with conventional functions with all the resulting advantages. Ideal for all types of food.



Cooking with the simultaneous use of the heating element in combination with fan and microwave supply.
- 

Microwave + grill element: The use of the grill results in a perfect browning of the surface of the food. The action of microwaves allows instead of cooking in a short time the internal part of the food.



Fan combined with traditional cooking, where heat is generated from above and below, provides uniform heat. Adding the microwave function allows the same cooking results in less time.
- 

This function can reheat precooked dishes, without becoming dry or hard.



Circulaire with upper and lower elements: The use of the fan with both elements allows food to be cooked quickly and effectively, ideal for large joints that require thorough cooking. It offers a similar result to rotisserie, moving the heat around the food, instead of moving the food itself, enabling any size or shape to be cooked.
- 

Compact appliances with a height of 45 cm - perfect solution to meet the functional requirements of kitchen sets of small height. Available in several types and in different styles.



KEEP_WARM_72dpi
- 

Side lights: Two opposing side lights increase visibility inside the oven.



ECO-logic: option allows you to restrict the power limit of the appliance real energy saving.
- 

Air at 40°C provides the perfect environment for proving yeast type dough mixes. Simply select the function and place dough in the cavity for allotted



Sabbath: This function allows you to cook food during the Sabbath, the Holiday of rest in the Jewish religion, respecting the precepts. The oven works
- 

The oven cavity has 3 different cooking levels.



Soft close: all models are equipped with advanced function of smooth closing of the door, which allows the device to close smoothly and quietly.
- 

Telescopic rails: allow you to pull out the dish and check it without having to remove it from the oven entirely.



Electronic control: Allows you to maintain temperature inside the oven with the precision 2-3 ° C. This enables to cook meals that are very sensitive to temperature changes, such as cakes, souffles, puddings.



Tilting grill: the tilting grill can be easily unhooked to move the heating element and clean the roof of the appliance in one simple step.



Vapor Clean: a simple cleaning function using steam to loosen deposits in the oven cavity.



The capacity indicates the amount of usable space in the oven cavity in litres.



The capacity indicates the amount of usable space in the oven cavity in litres.