

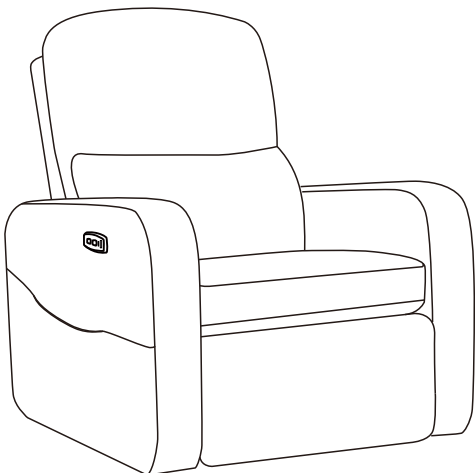

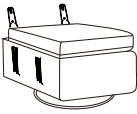

■ CONTENTS

1. Contents
 2. Fitting list Installation Guidance
 3. Usage Information
 4. Attention
 5. Maintenance and Warning
 6. Contact Details
-

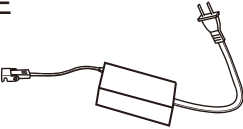

FITTING LIST

A 	B 	C 	D 
Chair base	Backrest	Left armrest	Right armrest
E 			
Power source			

ASSEMBLY INSTRUCTIONS

STEP 1: Please take out the armrest from the carton, align the inserts accurately, and buckle them down firmly.

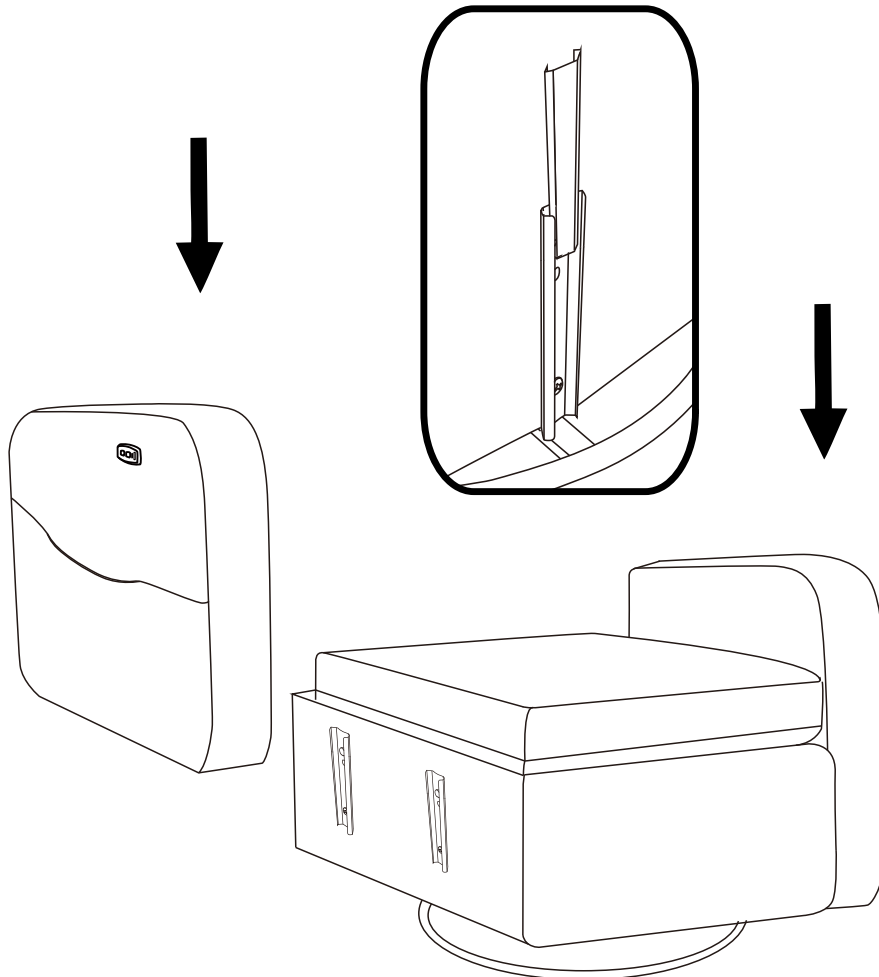

STEP 2: Take out the backrest and find the position of the backrest insert and the position of the seat cushion slot. Align the insert with the two slots on the seat cushion simultaneously and gently push down. When you find that it can be fully embedded, press down again to make the insert and the slot completely buckle. When the backrest is completely installed with the seat cushion and there is no looseness, it means it is completed. Just so you know, if the backrest is loose, please check whether the insert is installed correctly. If you want to take the backrest out again, please forcefully pry open the slot and lift the backrest up at the same time.

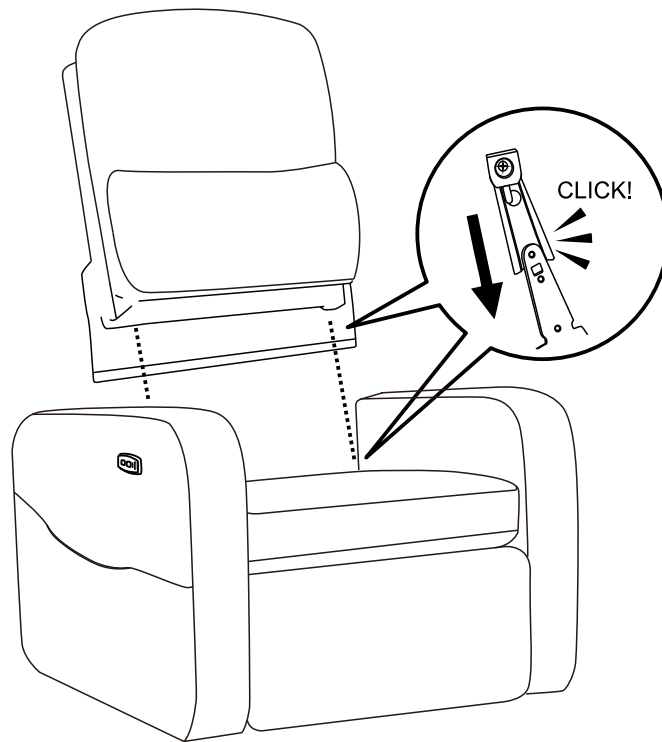

STEP 3: Please follow the steps to plug in the power

(How to connect a line)

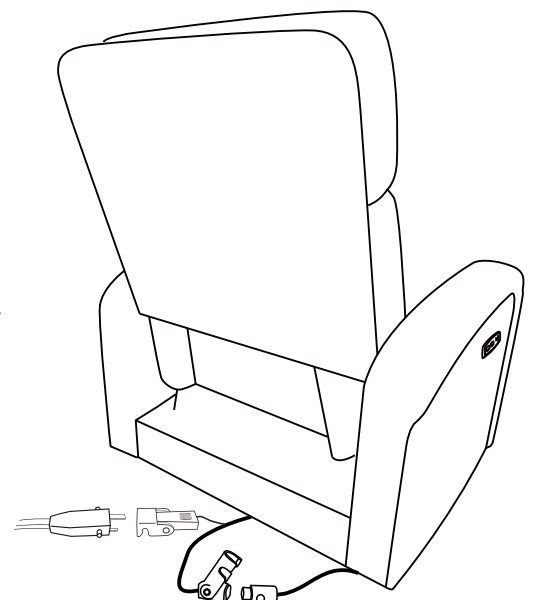
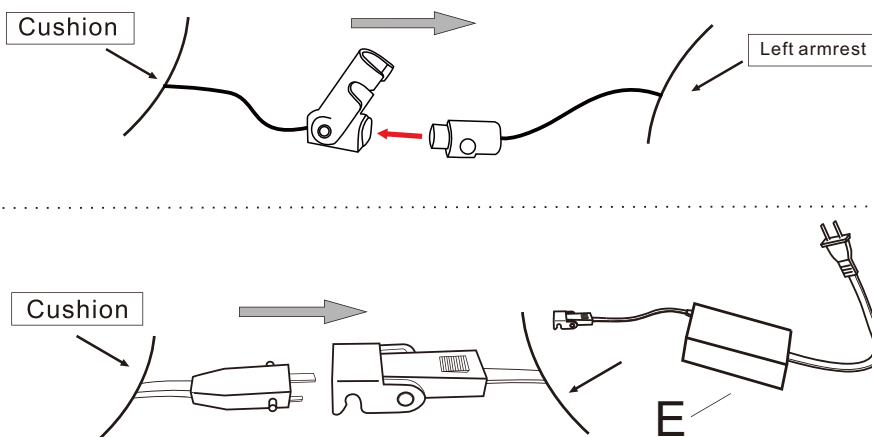

STEP 4: Functional display of the left armrest

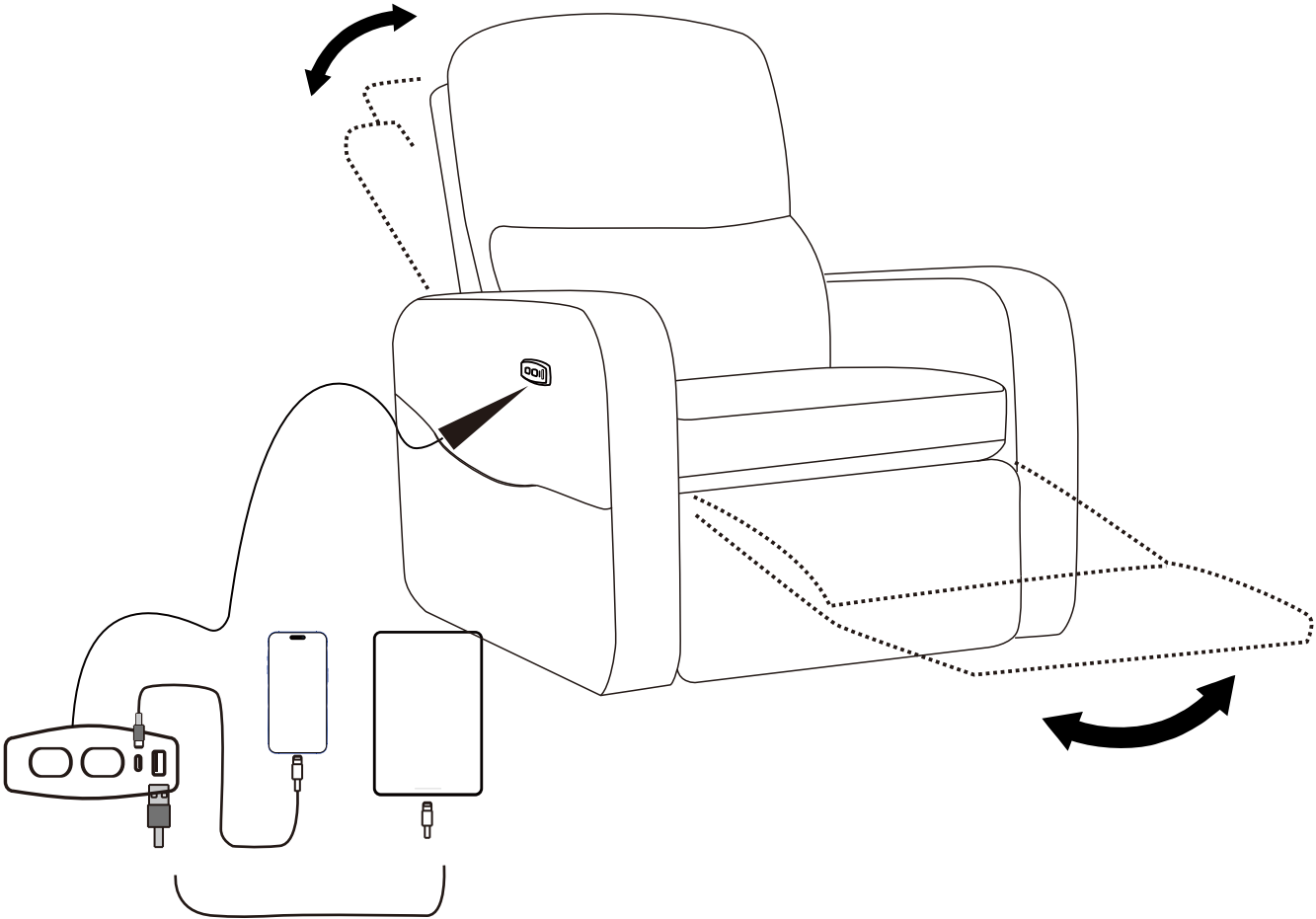

STEP 5: A complete product display

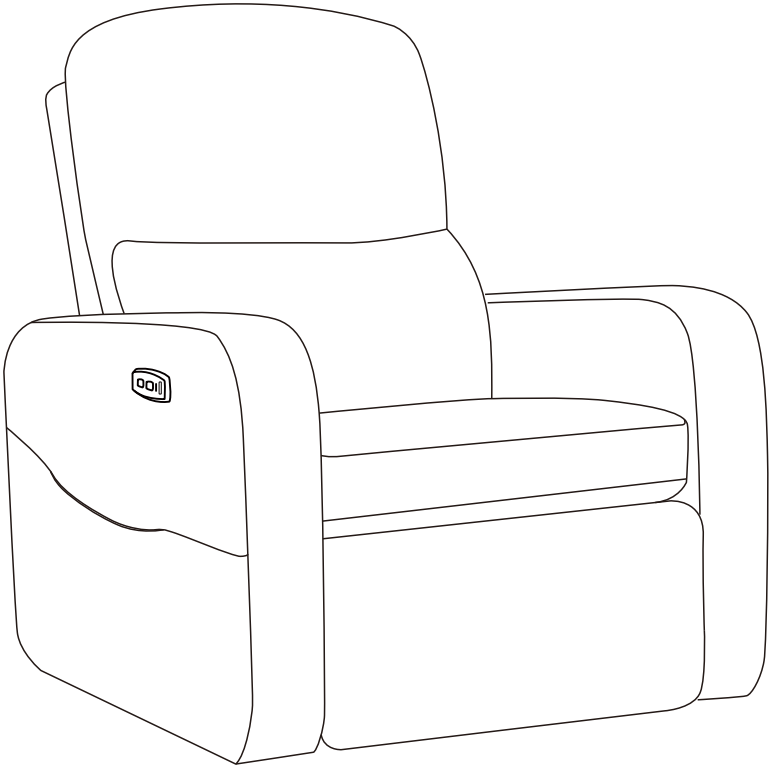

TO STORE OR CLEAN

Maintenance

Instructions

Rotate reversible cushions regularly.

Turn over & Rotate

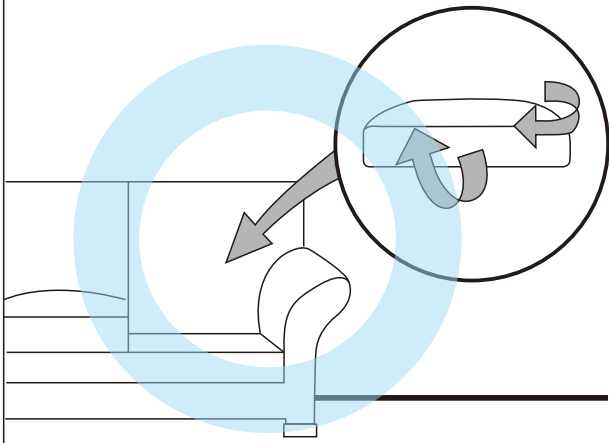

Vacuum your furniture regularly with upholstery tools.

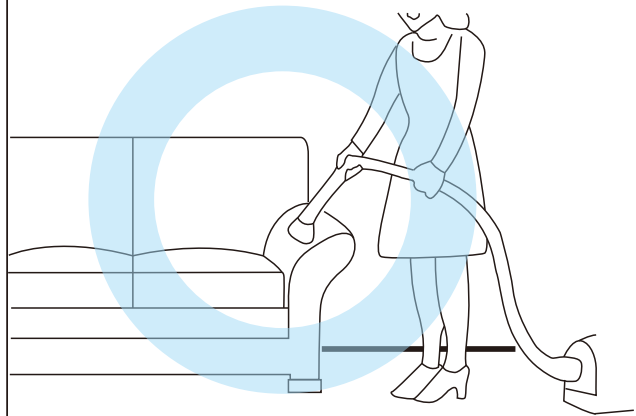

Do not expose your furniture to prolonged periods of direct sunlight.

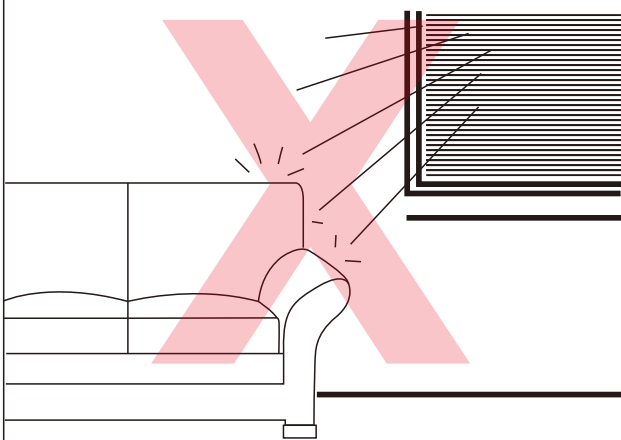

Do not place your furniture close to a radiator or similar heat source.

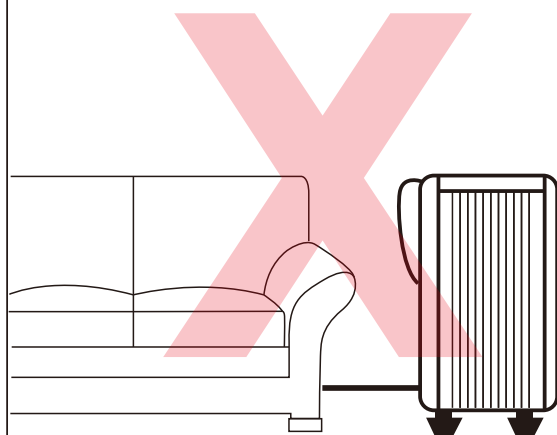

ATTENTIONS

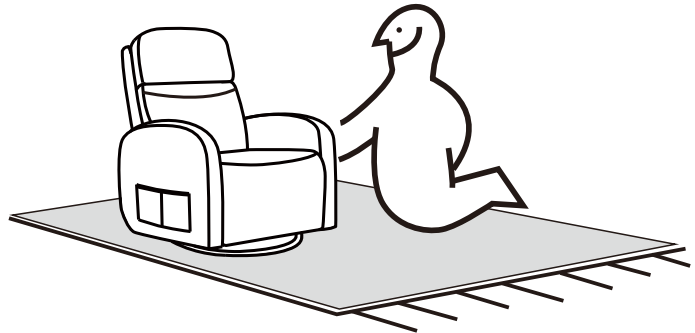
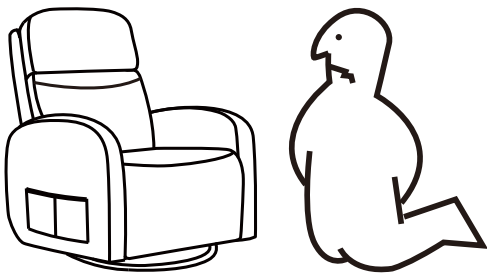
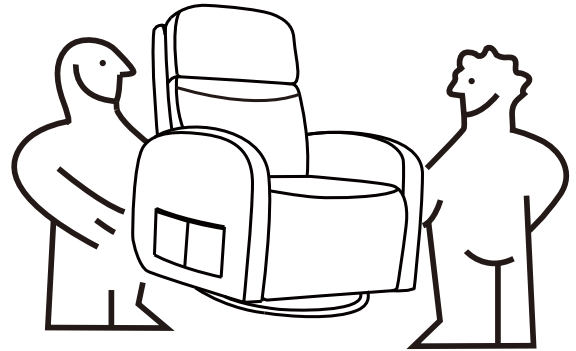
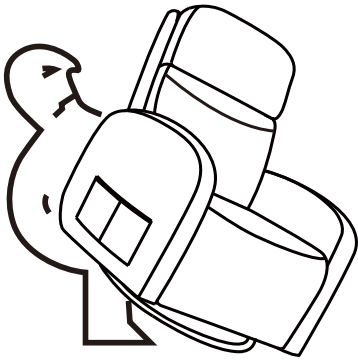

Put a carpet under the sofa to protect your floor while assembling

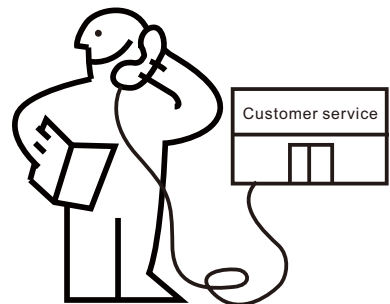
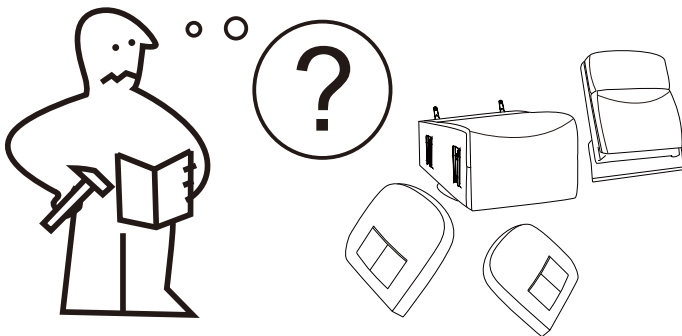

MAINTAINANCE AND WARNING

- 👉 Keep furniture away from heat.
 - 👉 Do not clean furniture with harsh cleansers or polish.
 - 👉 Do not use detergents, Solvents, abrasives, spray packs or leather cleaner.
 - 👉 Use non-color mild soap with warm water clean
 - 👉 Do not use on site dry Cleaning machine.
 - 👉 Children should not climb or jump on the furniture.
 - 👉 Do not write on furniture without a padded barrier to protect the surface.
- Not for commercial use, For residential use only.
- 👉 spills(Mix 1:10 soap to water) Do not place furniture under direct sunlight, material will possibly fade over time.

For return, please check the return policy with the retailer or market place you bought from.

*Appreciate your purchasing from us.
Pop up your life by our furniture piece!*
