

# 54" FOOSBALL TABLE

## Important!

Before starting assembly, please read through this instruction book to familiarize yourself with all the parts and assembly steps. Two person adult assembly is required. Please refer to the parts list below and be sure that all parts have been included.











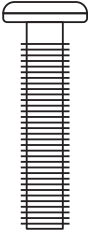
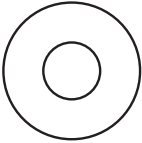
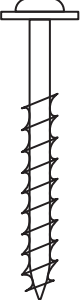
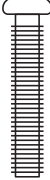



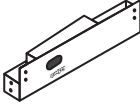
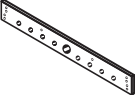
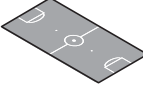



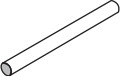

## Customer Service:

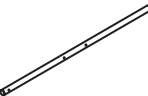
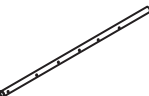
If you have any questions or concerns regarding your GoSports® Foosball Table, please reach out to us at [Info@PlayGoSports.com](mailto:Info@PlayGoSports.com) and we will get back to you right away. We stand behind our products 100% and want to make sure you get the full enjoyment that you paid for.

VIDEO INSTRUCTIONS  
(SCAN WITH PHONE  
CAMERA TO WATCH)

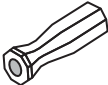

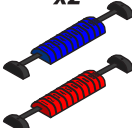
## Parts Included:

<p><b>A</b> 30mm BOLT x24</p>  <p>*true to size</p>	<p><b>B</b> WASHER x24</p>  <p>*true to size</p>	<p><b>C</b> 40mm SCREW x4</p>  <p>*true to size</p>	<p><b>D</b> 23mm BOLT x26</p>  <p>*true to size</p>	<p><b>E</b> 28mm SCREW x4</p>  <p>*true to size</p>	<p><b>F</b> 12mm SCREW x10</p>  <p>*true to size</p>	
<p><b>G</b> ALLEN WRENCH/ SCREWDRIVER x2</p> 	<p><b>H</b> GOAL END BOARD x2</p> 	<p><b>I</b> SIDE BOARD x2</p> 	<p><b>J</b> PLAYFIELD x1</p> 	<p><b>K</b> SUPPORT BRACE x2</p> 	<p><b>L</b> LEFT LEG x2</p> 	<p><b>M</b> RIGHT LEG x2</p> 
<p><b>N</b> LEG SUPPORT CROSSBAR x2</p> 	<p><b>O</b> LEG LEVELER x4</p> 	<p><b>P</b> BALL ENTRY x2</p> 	<p><b>Q</b> 3 PLAYER ROD x4</p> 	<p><b>R</b> 2 PLAYER ROD x2</p> 	<p><b>S</b> 5 PLAYER ROD x2</p> 	<p><b>T</b> PLAYER (RED) x13</p> 
<p><b>U</b> PLAYER (BLUE) x13</p> 	<p><b>V</b> RUBBER BUMPER x16</p> 	<p><b>W</b> HAND GRIP x8</p> 	<p><b>X</b> END CAP x8</p> 	<p><b>Y</b> SCORE TRACKER x2</p> 	<p><b>Z</b> CUP HOLDER x2 <i>optional</i></p> 	<p>SOCCER BALL x4</p> 

## Assembly Instructions: Estimated Assembly Time: 35-45min

### 2 Person Adult Assembly Required

- Must Follow Steps in Exact Order  
for Proper Assembly

1. Open the box near where you will play. Select an open indoor space with a level floor. Remove all of the contents and verify that you have all of the listed parts. We suggest you use the opened cardboard box as a clean flat working area to protect the game.

### OPTIONAL TOOLS FOR FASTER ASSEMBLY:

PHILLIPS SCREWDRIVER (NOT INCLUDED)

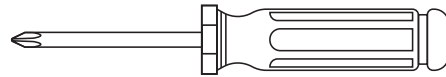

2. You will first begin assembling the table face down. Attach one goal end board (H) between two sideboards (I) using two 30mm bolts (A) and two washers (B) per side, using Allen wrench (G).

**NOTE:** Do not tighten screws completely until after the playfield has been inserted (see next step).

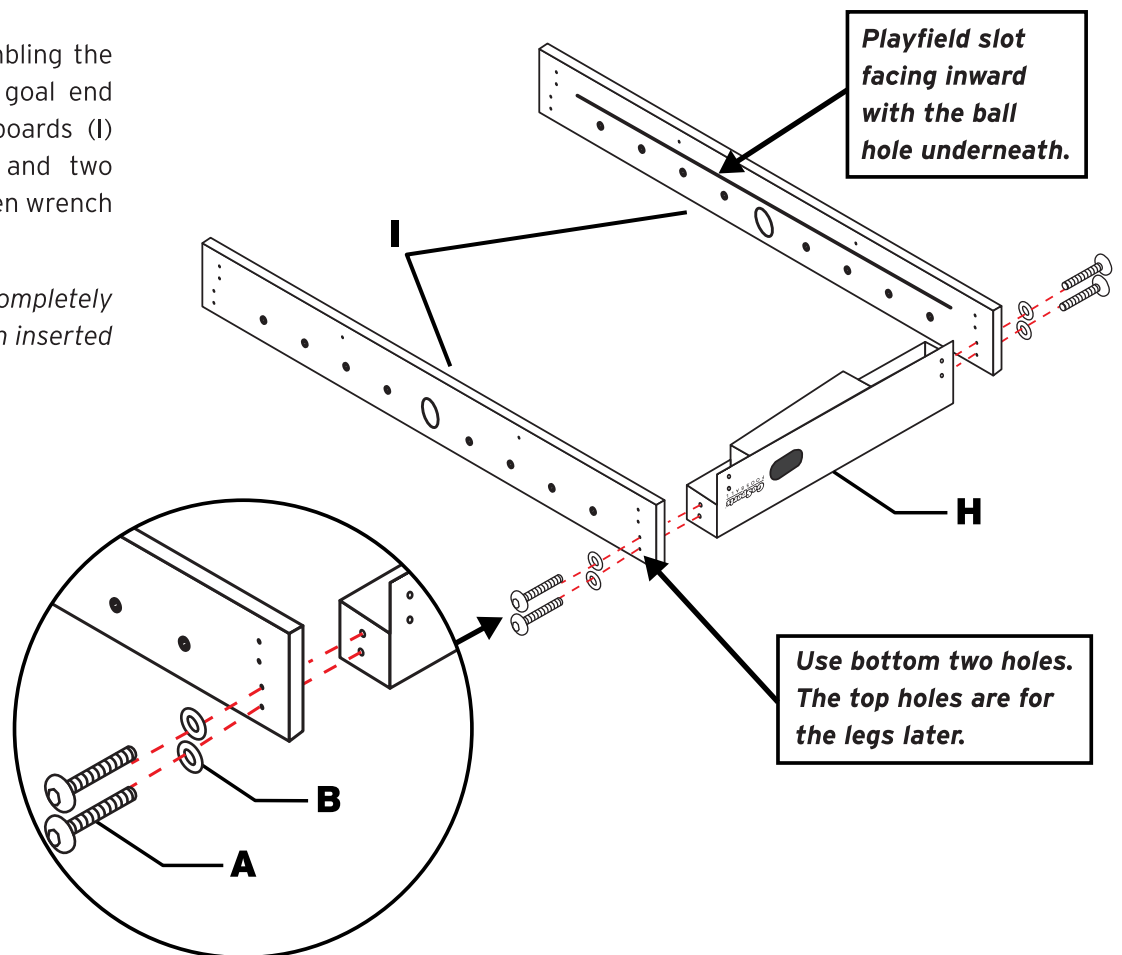

3. With 2 adults, tilt the frame upright and insert the playfield (J) into the slots along the sideboards. If the playfield does not slide in smoothly, check to be sure you have not over-tightened the bolts from step 2 and that the playfield is completely aligned into the slots along the interior sideboards.

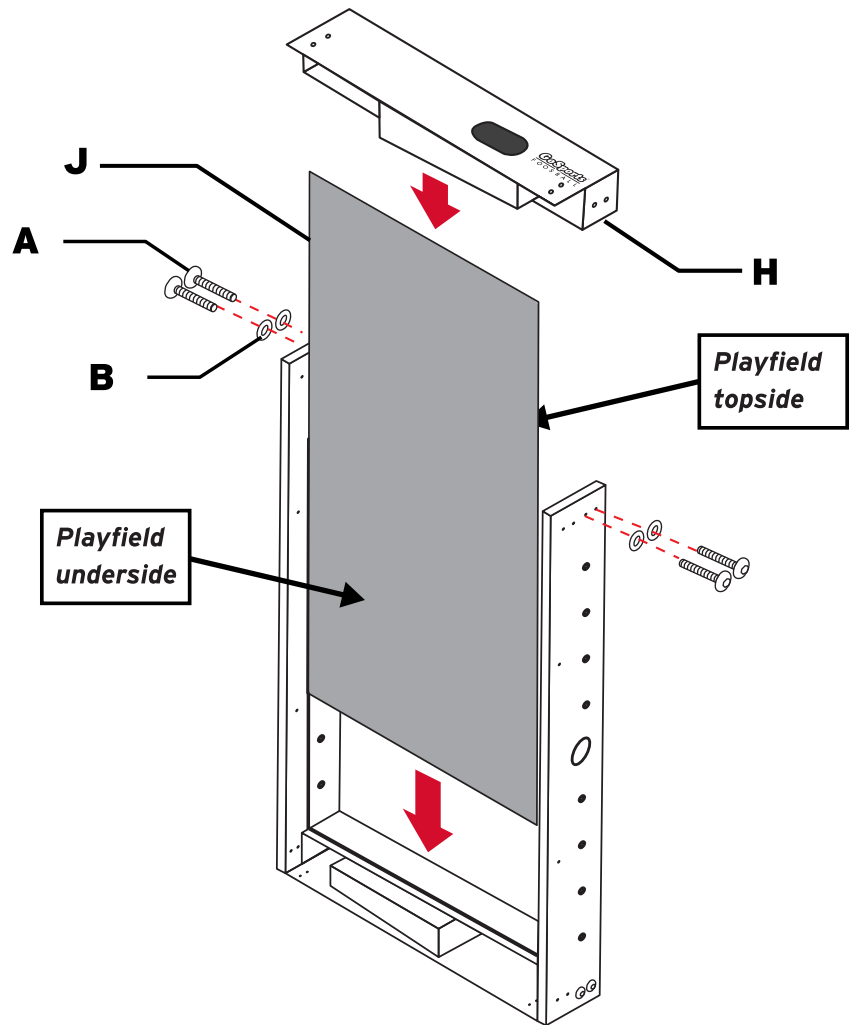

4. Once the playfield is in place, attach the other goal end board (H) between the two sideboards using two 30mm bolts (A) and 2 washers (B) per side. Firmly tighten all eight 30mm bolts (A) including those from step 2 on the opposite end.

5. With the playfield (J) facedown, place the support braces (K) on the playfield and attach them using four of the 40mm screws (C) as shown.

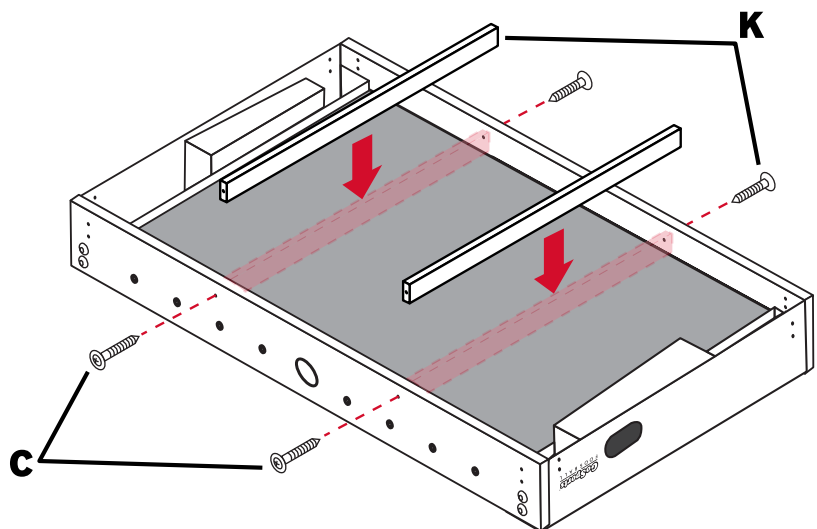

6. Insert the left (L) and right (M) legs into the corners of the table. Confirm all pre-drilled holes on the legs and the table match up correctly as shown. Make sure the crossbar holes are facing inwards, towards each other. Insert the leg support crossbar (N) between each set of legs.

**NOTE:** You must insert the crossbar between the legs before bolting the legs to the table.

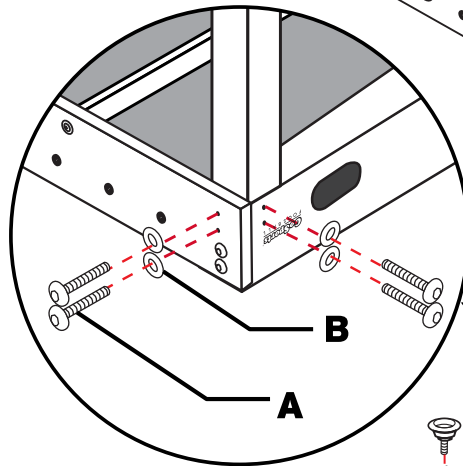
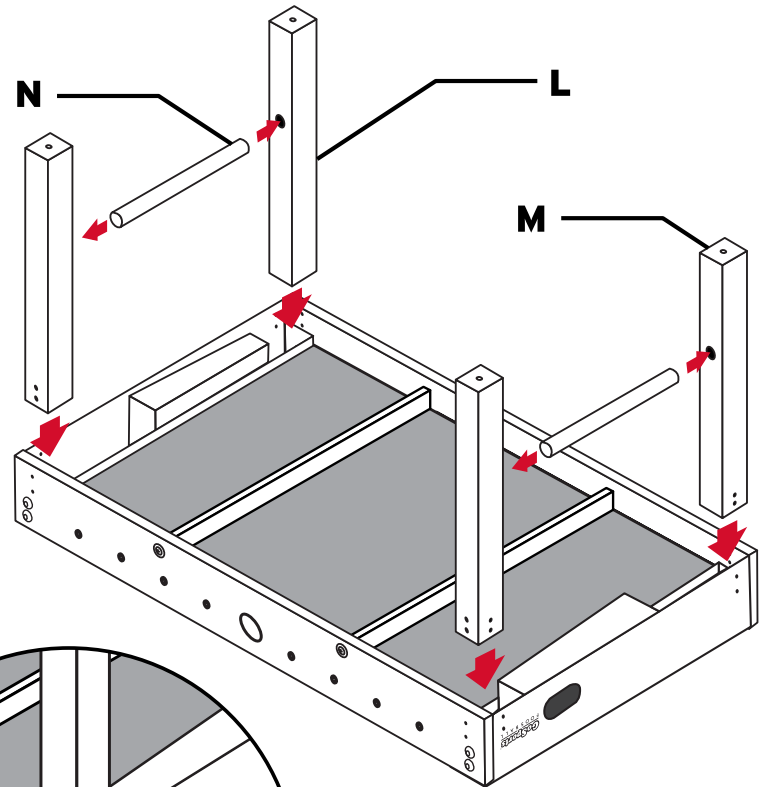

Repeat on all four legs.

7. Now attach the legs using four 30mm bolts (A) and four washers (B) per leg as shown. Firmly tighten the bolts and repeat for all four legs.

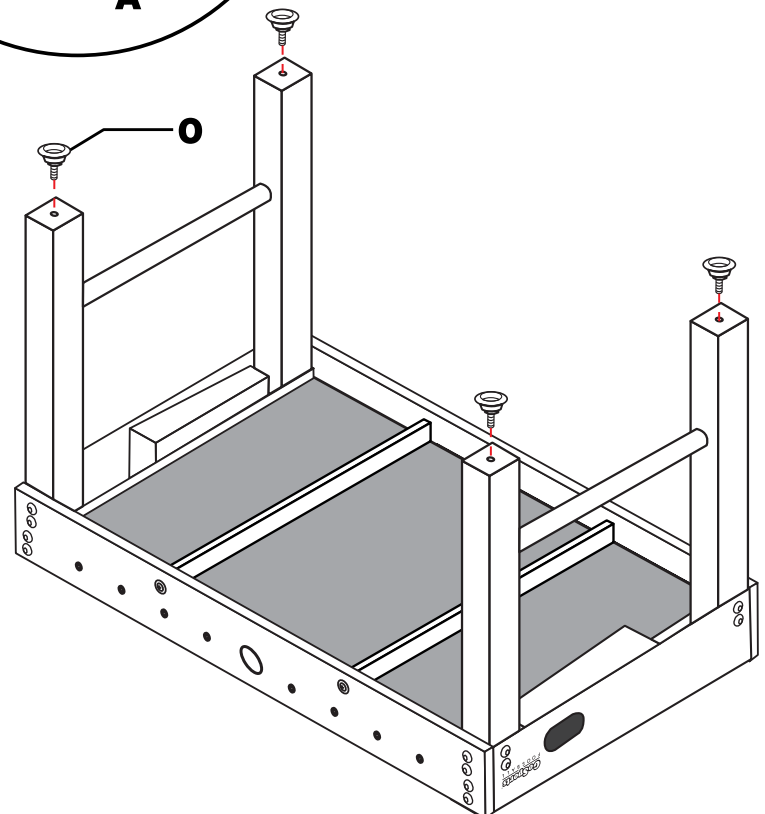

8. Locate the leg levelers (O) and twist one into each leg as shown.

9. With 2 adults carefully flip the table over, so it is standing right side up. Do not lean the table when flipping it over. Ensure all bolts are firmly secured before proceeding.

10. Now lay out the player rod configuration before attaching to the table as follows: Q, R, Q, S, S, Q, R, Q.

**NOTE:** You must follow steps 10 and 11 exactly in order for proper setup.

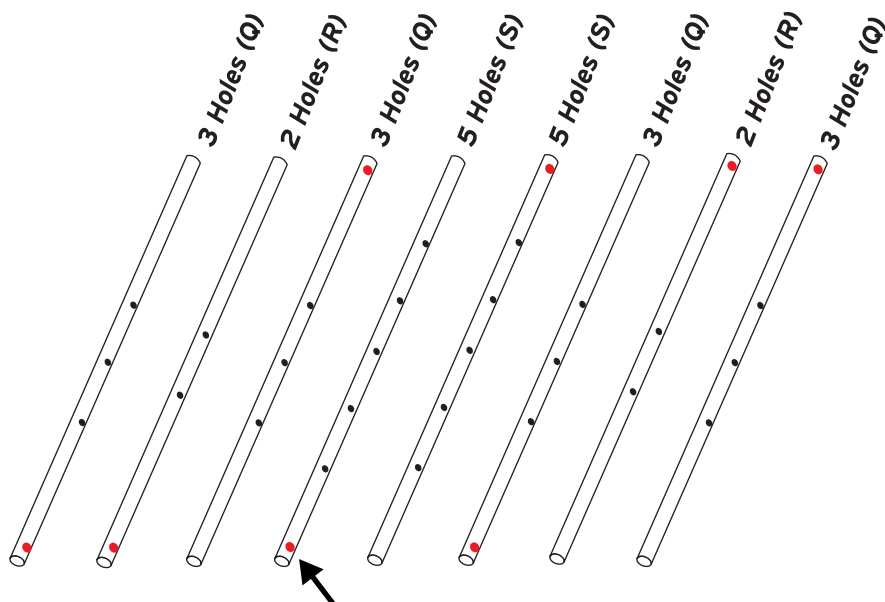

**Important:** You must also arrange the player rods so that the holes on the ends match the above configuration (shown in red). This is important for how the hand grips attach in step 14.

11. With the bolt opening on the players facing forward, slide the red players (T) and blue players (U) onto each rod as shown in the illustration. Ensure all blue players are facing one direction and all red players are facing the opposite direction. Slide a rubber bumper (V) on each side of the individual rods, on the outside of your players.

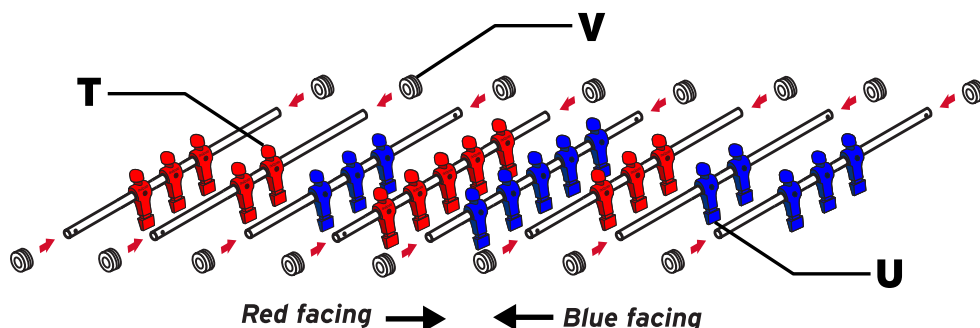

12. With the correct player configurations and bumpers on the rods, insert each rod into the corresponding holes in the table in the same order as shown on the illustration.

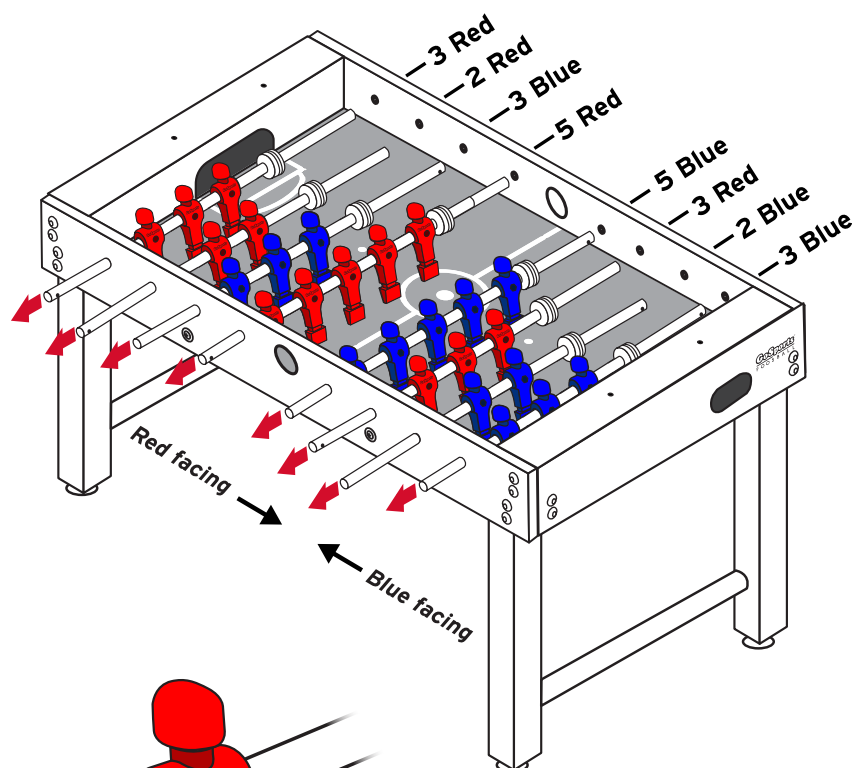

13. Once the rods and players are in the correct position and facing the correct direction, align each player with the holes in the rod and secure with 20mm bolts (D). Repeat for all players and ensure all bolts are firmly tightened.

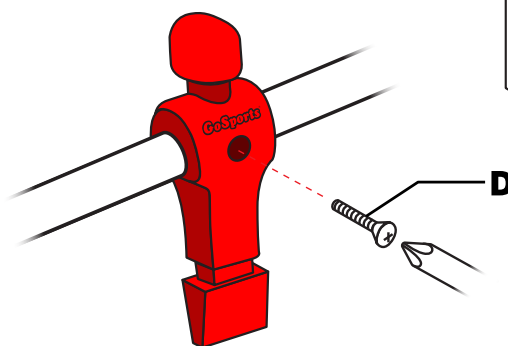

14. Slide the hand grips (W) and end caps (X) onto the player rods in the order as shown. Attach hand grips to any rod with a hole on the end and caps to the opposite end. Use a twisting motion and push in to slide the hand grips and end caps on.

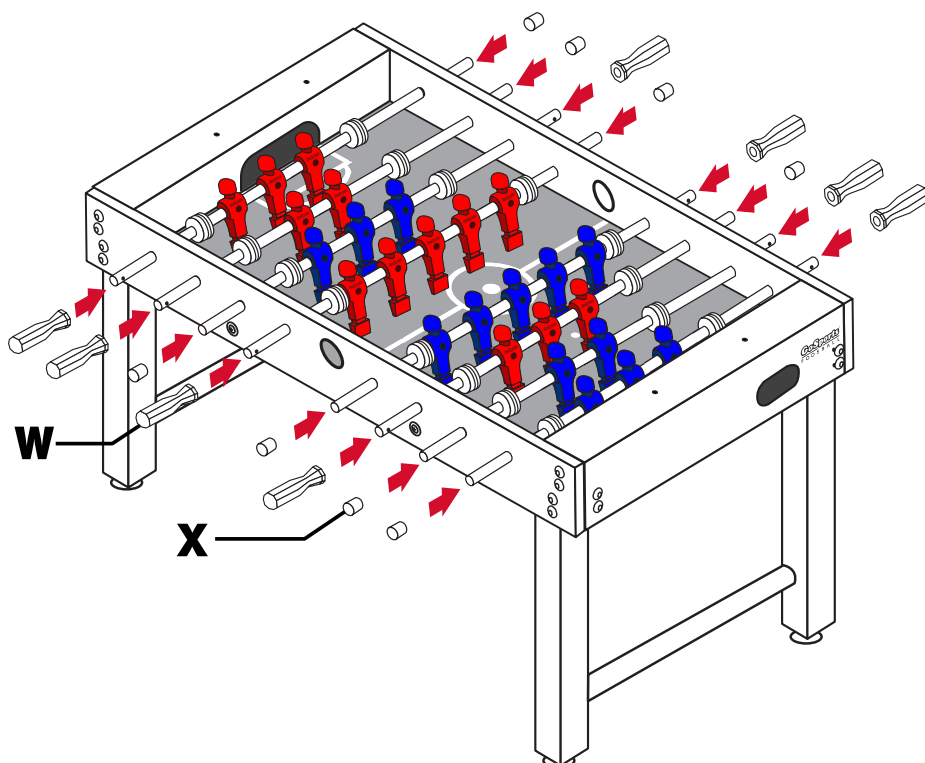

15. Attach the two score trackers (Y) to the two goal end boards (H) using two 28mm screws (E) per score tracker.

16. Connect the two Ball Entry (P) pieces through the hole on the long side of the frame. Then secure with one 12mm screw (F). Repeat on opposite side.

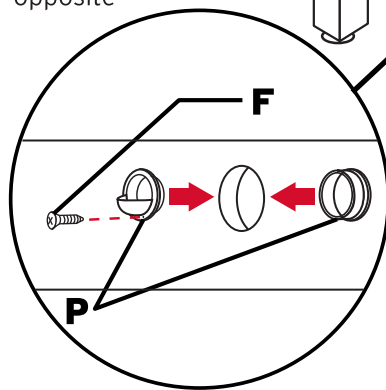

17. **OPTIONAL CUP HOLDERS:** Cup holders are included, but installing them is optional as some users prefer the minimalistic look. If you like the cup holders, installing them is easy, otherwise ignore the following step and start playing!

Attach the two cup holders (Z) to the two goal end board (H) using four 12mm screws (F) per holder. We recommend using a Phillips head screwdriver for this step. Attach to the left hand side of the board, opposite the ball return opening. There are no pre-drilled holes (since the cup holders are optional) so press firmly when screwing in.

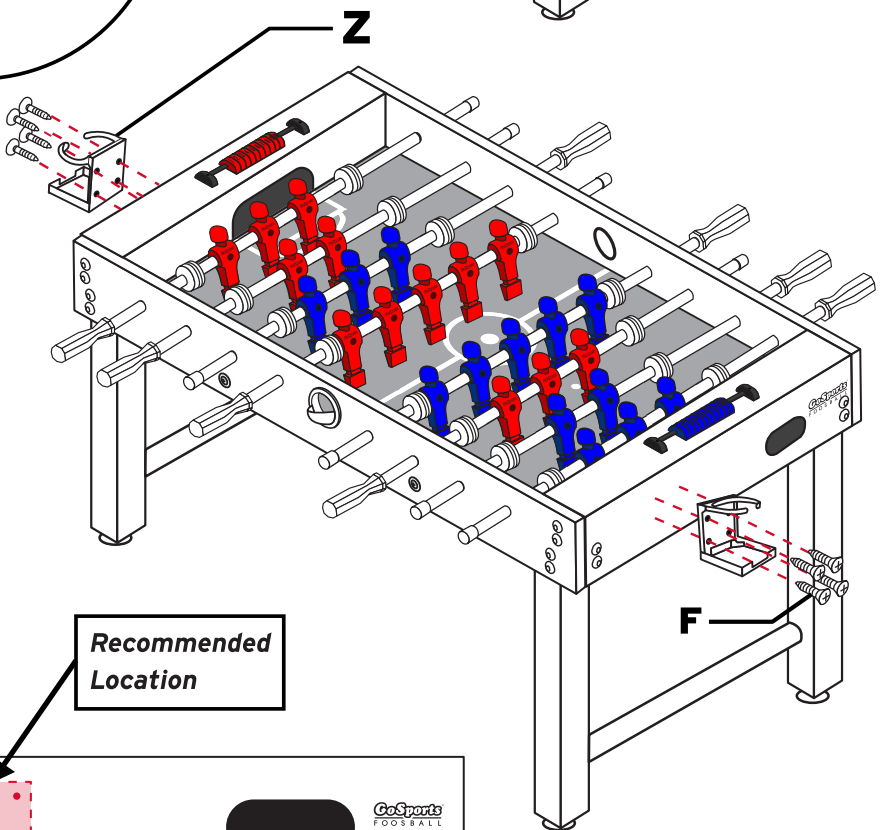
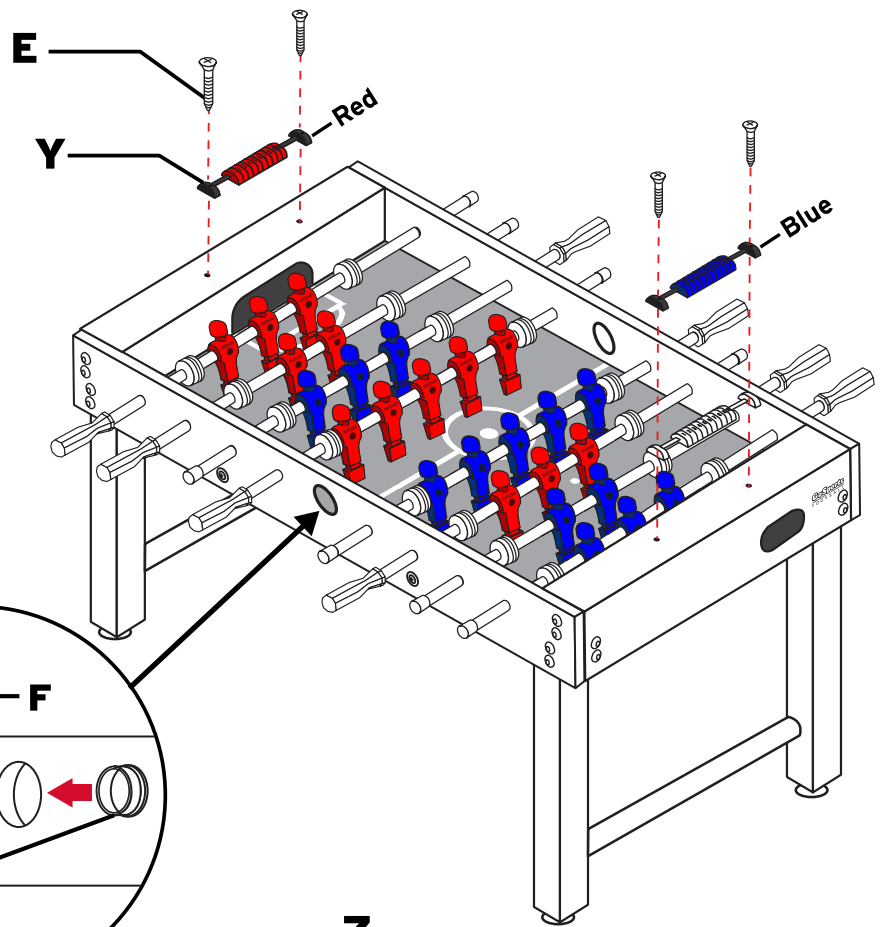

**Recommended Location**

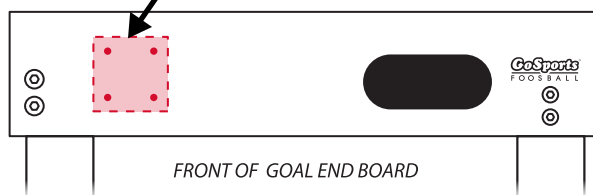

## Standard Gameplay, 2-4 Players

### Objective:

First player to score 10 goals wins the game. Alternatively you can play to 5 goals for a shorter game.

### How to Play:

- For 2 players, each player controls one color team.
- For 4 players, one team member controls the offense, the other controls the defense.
- To start the game, a player drops the ball into the center of the table through the side opening. Players then rotate the handles to kick the ball forward towards their opponent's goal.
- Spinning and jarring are not allowed. Players must not spin their handles a full 360 degrees. Also, they must not purposely move or push the table during gameplay.
- If the ball stops rolling and neither team is able to reach it with their players or if the ball bounces off the table, this is considered a dead ball and it must be restarted through one of the side ball openings.
- Be the first team to score 10 goals to win. If playing multiple games, the player to win the majority wins the entire match.

### WARNING:

- 2 person adult assembly required
- Keep individual parts away from small children; Pieces may be a choking hazard
- Always play on a level surface and adjust the feet levelers as needed
- Careful not to stand too close to the table when playing; Rods can poke/jab you
- Never sit on/under the table, lean, or stand on the table
- Keep hands outside of the table and away from the playing field during gameplay
- Store table indoors
- Never leave drinks unattended

## Customer Service:

If you have any questions or concerns regarding your GoSports® Foosball Table, please reach out to us at [Info@PlayGoSports.com](mailto:Info@PlayGoSports.com) and we will get back to you right away. We stand behind our products 100% and want to make sure you get the full enjoyment that you paid for.