

ASSEMBLY INSTRUCTIONS

Description : UPHOLSTERED BED

Thank you for purchasing this quality product. Be sure to check all packing material carefully for small part that may have come loose inside the carton during shipment.

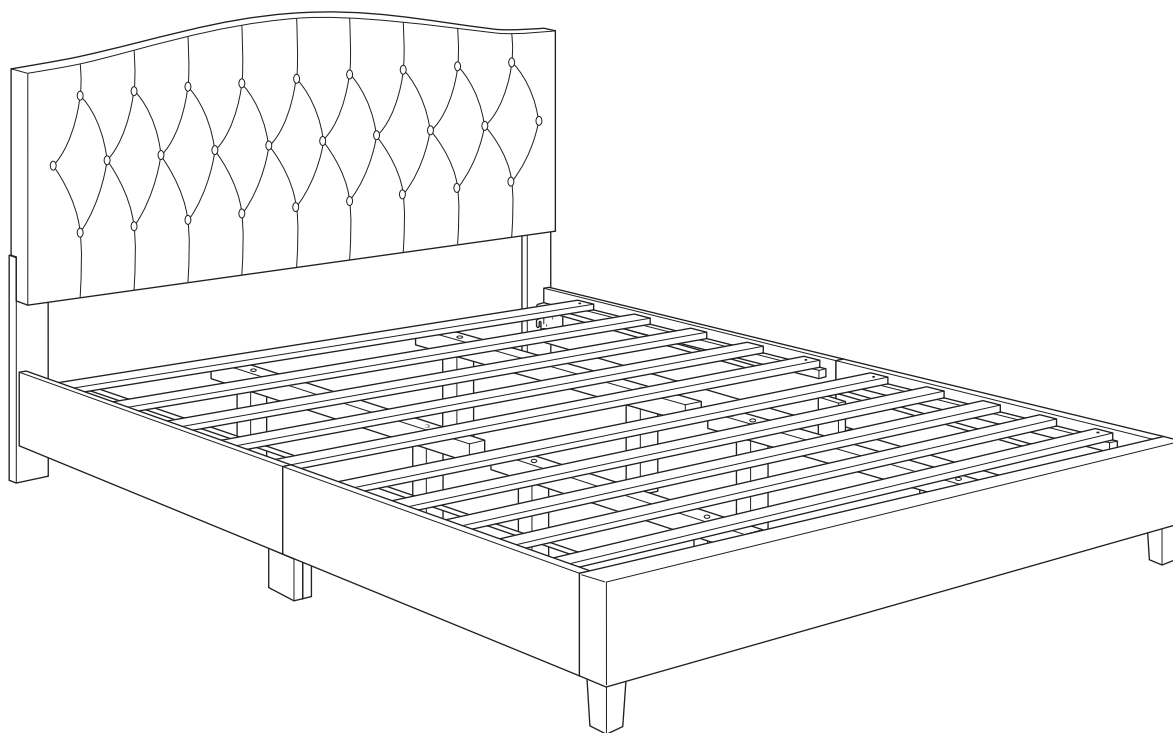

ASSEMBLY INSTRUCTIONS

Description : UPHOLSTERED BED

Thank you for purchasing this quality product. Be sure to check all packing material carefully for small part that may have come loose inside the carton during shipment.

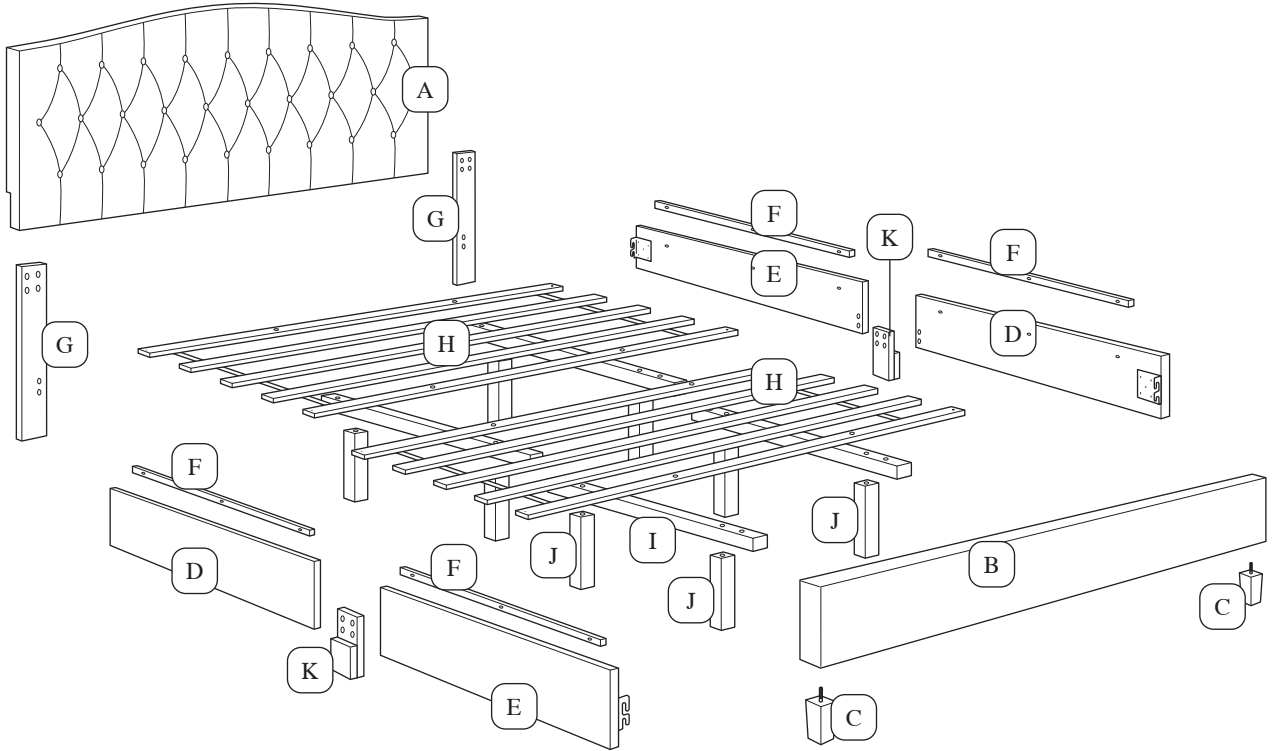

PART LIST:			
No.	Description	Sketch	Quantity
A	Headboard		1 PC
B	Footboard		1 PC
C	Leg		2 PCS
D	Side Rail 'D'		2 PCS
E	Side Rail 'E'		2 PCS
F	Side Rail Support		4 PCS
G	Leg Pillar L/R		2 PCS
H	Slat		2 SETS
I	Bed Center Rail		4 PCS
J	Slat Support Leg		8 PCS
K	Support Side Rail		2 PCS

TOOLS REQUIRED (Not provided)	
	Screwdriver

HARDWARE LIST:			
No.	Description	Sketch	Quantity
1	CSK M4 x 16mm		16 PCS
2	CSK M4 x 32mm		8 PCS
3	JCBC M6 x 30mm		8 PCS
4	JCBC M6 x 35mm		12 PCS
5	JCBC M6 x 50mm		16 PCS
6	JCBB M8 x 30mm		8 PCS
7	Flat Washer M6		28 PCS
8	Spring Washer M6		28 PCS
9	Allen Key M4		1 PC
10	Allen Key M5		1 PC
11	Plastic Washer Leg		2 PCS
12	Adjuster Leg		8 PCS

ASSEMBLY INSTRUCTIONS

Description : UPHOLSTERED BED

Thank you for purchasing this quality product. Be sure to check all packing material carefully for small part that may have come loose inside the carton during shipment.



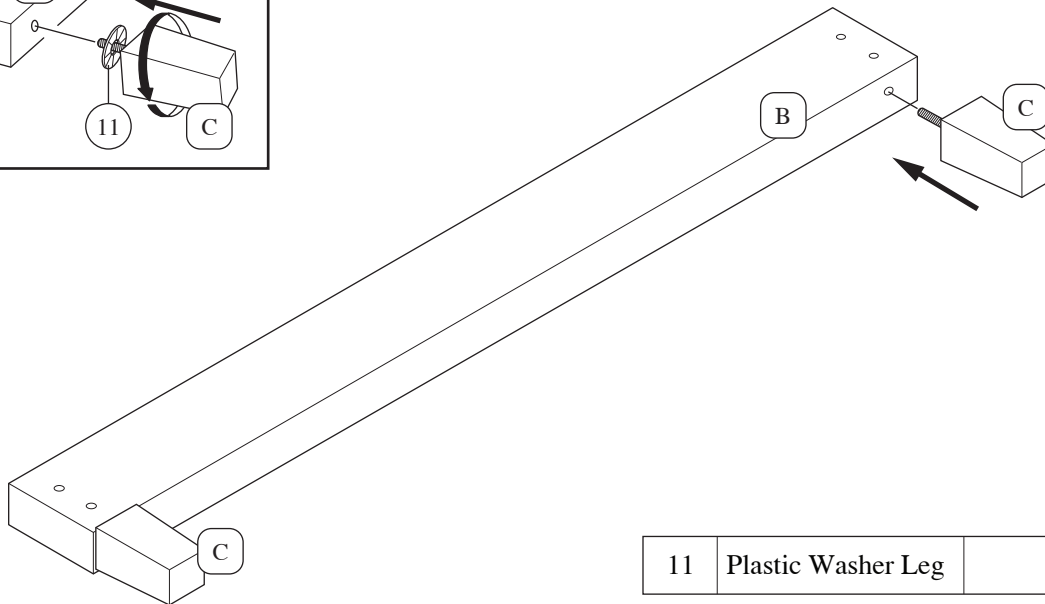
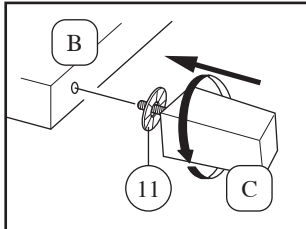

Step 1. Attach the Leg (C) with the Footboard (B) by using the Plastic Washer Leg (11).

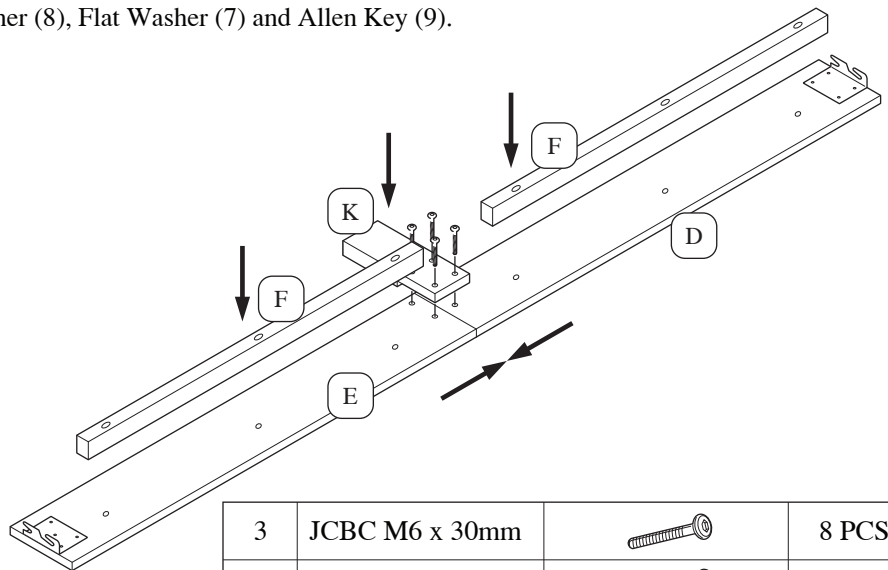
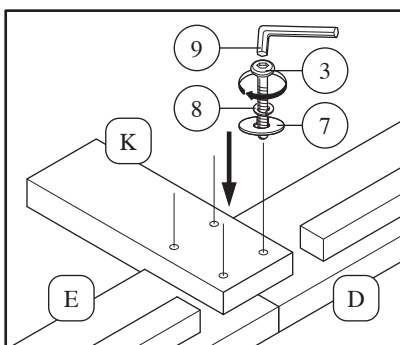
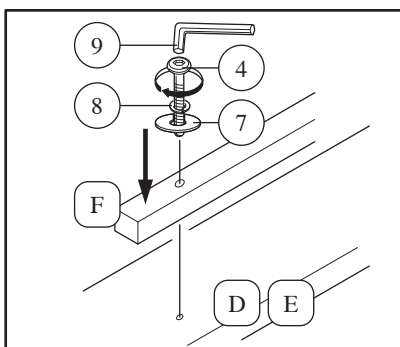

11	Plastic Washer Leg		2 PCS
----	--------------------	---	-------

Step 2. Attach the Side Rail Support (F) on Side Rail (D/E) by using the Bolt (4), Spring Washer (8), Flat Washer (7) and Allen Key (9). Put the Side Rail (D/E) symmetrical. Next, attach the Support Side Rail (K) with side rail (D/E) by using the Bolt (3), Spring Washer (8), Flat Washer (7) and Allen Key (9).



3	JCBC M6 x 30mm		8 PCS
4	JCBC M6 x 35mm		12 PCS
7	Flat Washer M6		20 PCS
8	Spring Washer M6		20 PCS
9	Allen Key M4		1 PC

ASSEMBLY INSTRUCTIONS

Description : UPHOLSTERED BED

Thank you for purchasing this quality product. Be sure to check all packing material carefully for small part that may have come loose inside the carton during shipment.

Step 3. Attach the Leg Pillar (G) on Headboard (A) by using the Bolt (5), Spring Washer (8), Flat Washer (7) and Allen Key (9).

5	JCBC M6 x 50mm		8 PCS
7	Flat Washer M6		8 PCS
8	Spring Washer M6		8 PCS
9	Allen Key M4		1 PC

Step 4. Please use the Bolts (6) to put on Leg Pillar (G) and Footboard (B) by using hand without tighten it. Next, hook the metal bracket on side rail (D/E) on the Bolts (6) and tighten them with Allen Key (10).

6	JCBB M8 x 30mm		8 PCS
10	Allen Key M5		1 PC



ASSEMBLY INSTRUCTIONS

Description : UPHOLSTERED BED

Thank you for purchasing this quality product. Be sure to check all packing material carefully for small part that may have come loose inside the carton during shipment.

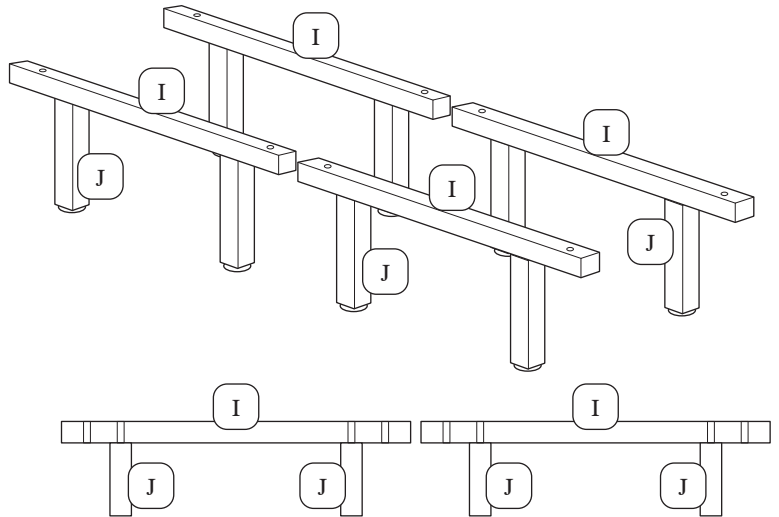
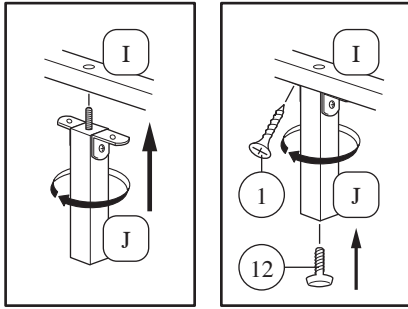

Step 5. Attach the Slat Support Leg (J) with Bed Center Rail (I) first and use screw (1) to tighten them.
Put Adjuster Leg (12) on bottom of slat support leg (J). Note: The adjuster leg (12) can be adjusted if the floor not flat.

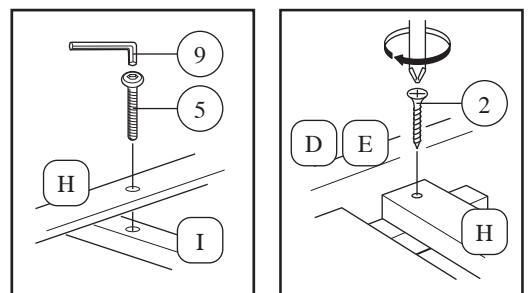
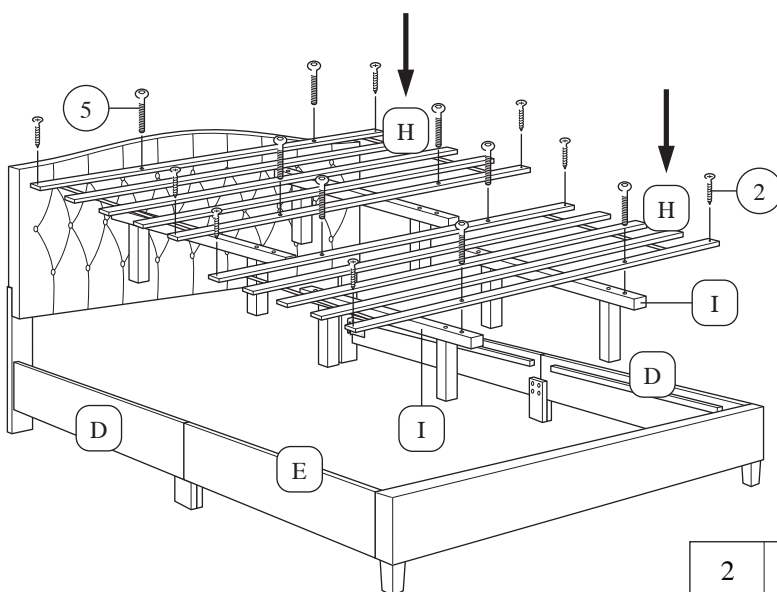

1	CSK M4 x 16mm		16 PCS
12	Adjuster Leg		8 PCS

Step 6. Put the Slat (H) on the Side rail (D/E) of the bed to be neat, then tighten them by using Screws (2).
Next, attach Bed Center Rail (I) with Slat (H) by using the Bolt (5) and Allen Key (9).



2	CSK M4 x 32mm		8 PCS
5	JCBC M6 x 50mm		8 PCS
9	Allen Key M4		1 PC