

As this item contains many parts, please read the installation instruction carefully before installation . Please use tools properly and carefully. If you have any questions about the product and installation, please contact us.

Our professional after-sales team will serve you online all day.

Before You Start

- ✓ Read through each step carefully and follow the proper order
 - ✓ Separate and count all your parts and hardware
 - ✓ Give yourself enough room for the assembly process
 - ✓ Have the following tools: Allen Wrench
 - ✓ Caution: If using a power drill or power screwdriver for screwing, please be aware of to slow down and stop when screw is tight. Failure to do so may result in stripping the screw. (Assembly speed can be increased by using electric screwdriver)
- 

Helpful Hints

PEOPLE NEEDED FOR ASSEMBLY: 1-2

- Open your item in the area you plan to keep it to avoid excessive heavy lifting.
- Identify, sort and count the parts before attempting assembly.
- Do NOT use harsh chemicals or abrasive cleaners on this item.
- Never push, pull, or drag your furniture.



Part List

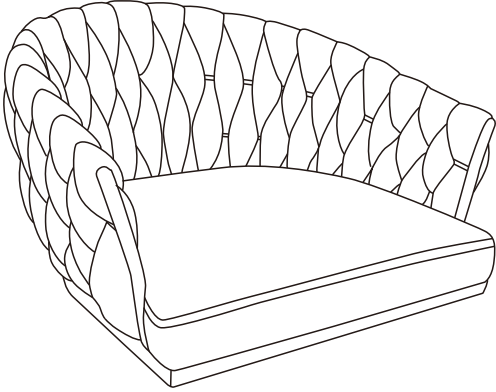

Ⓐ SEAT
QTY:1

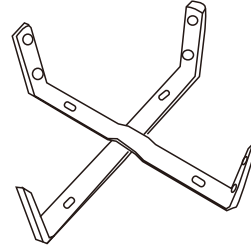

Ⓑ METAL CROSS
QTY:1

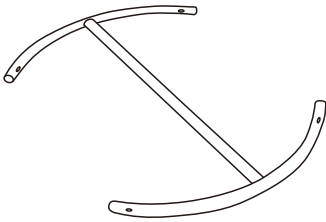

Ⓒ FOOTREST
QTY:1

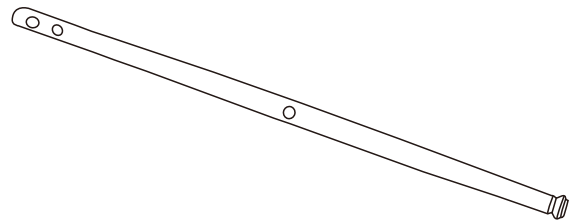

Ⓓ METAL LEGS
QTY:4

Part List

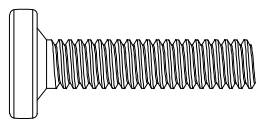

M6X20mm

①

X12

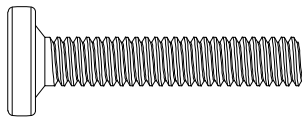

M6X25mm

②

X4

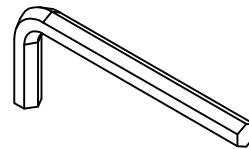

③

X1

STEP1

Attach the metal cross(B) to the metal legs (D) by using bolts(1) and Allen wrench(3).
Tighten all the screws 70% so that you can adjust slightly during the process of assembly.

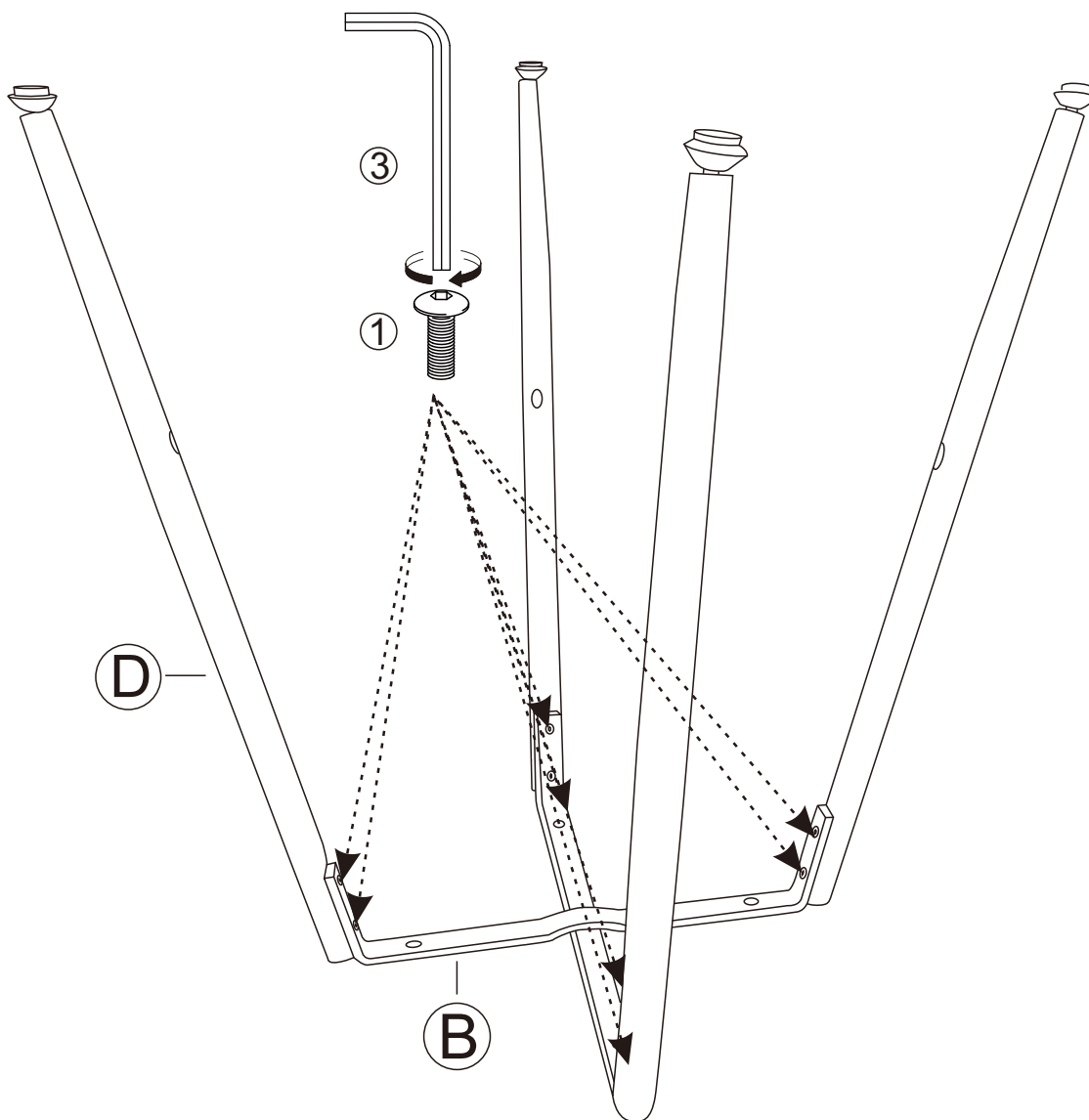
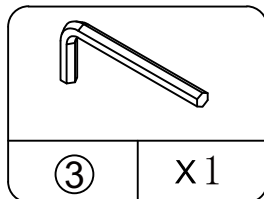
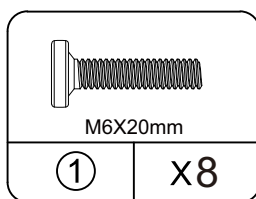

STEP 2 Attach the footrest(C) to the metal legs (D) by using bolts(2) and Allen wrench(3).
Tighten all the screws 70% so that you can adjust slightly during the process of assembly.

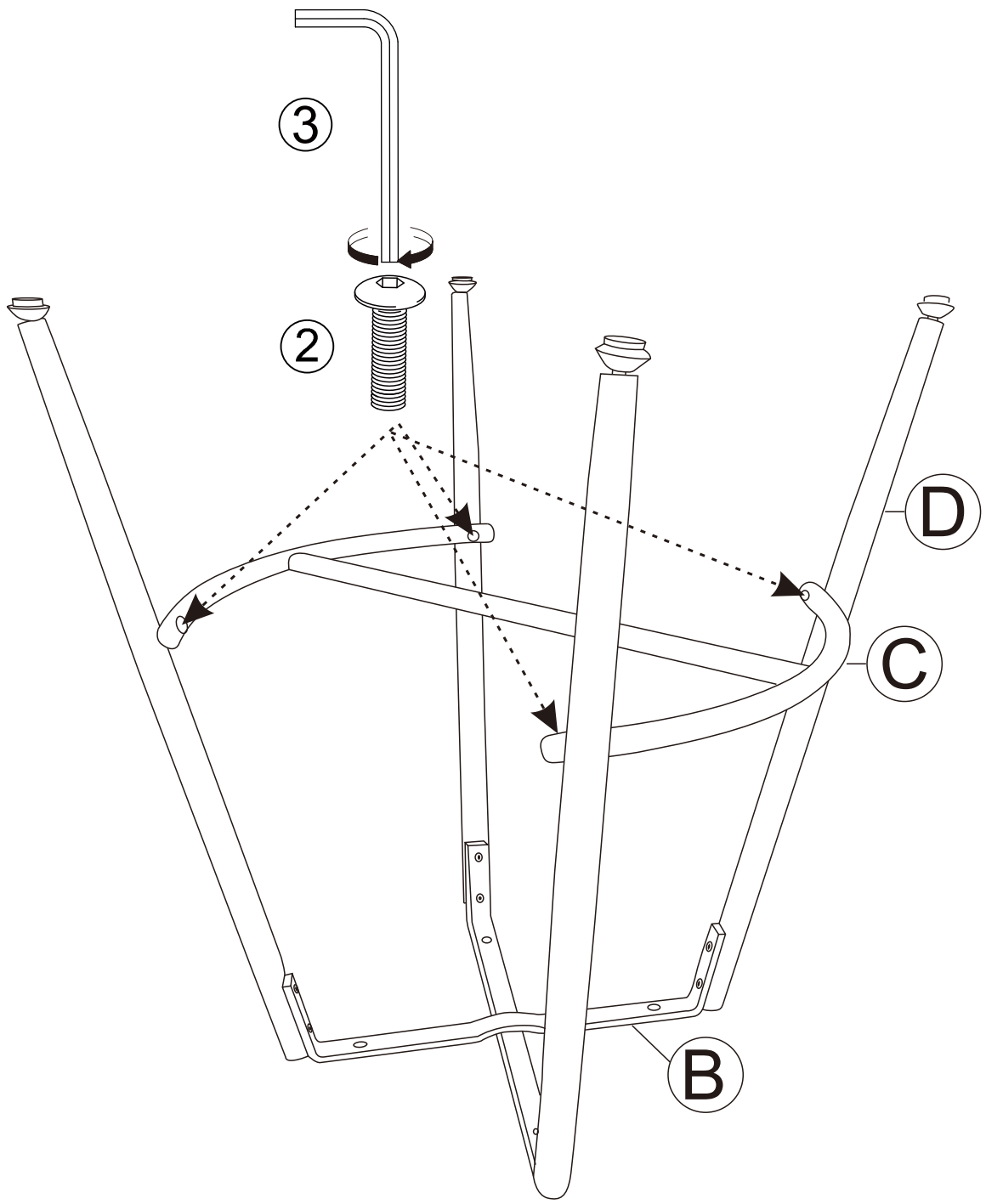
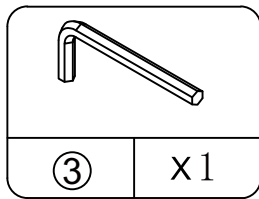
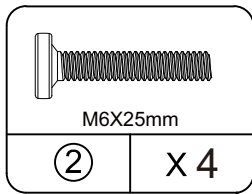

STEP 3

Attach the metal frame to the seat (A) by using bolts(1) and Allen wrench(3).
Tighten all the screws 70% so that you can adjust slightly during the process of assembly.

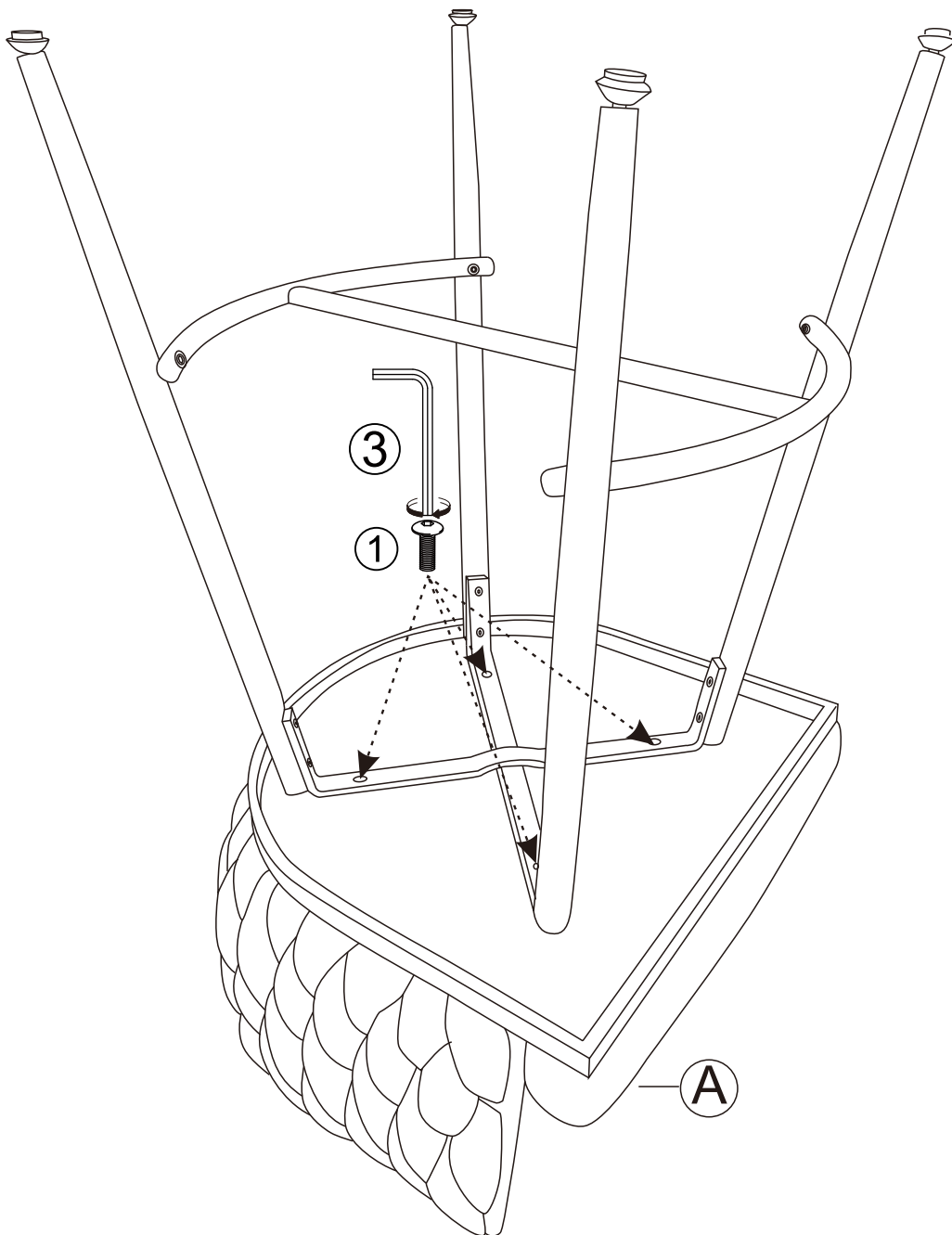
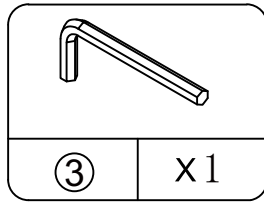
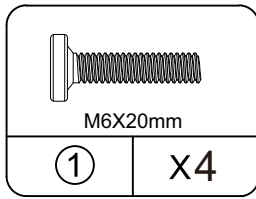

STEP 4 Tighten all bolts fully, and turn the assembled seat upright. Assembly completed.
If you find the chair not level, please adjust by rotating the feet pads on the legs.

