

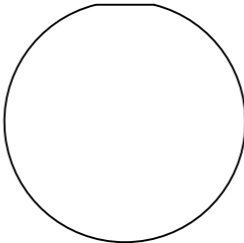





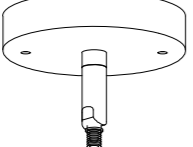

Installation Instruction

Part List and Hardware List

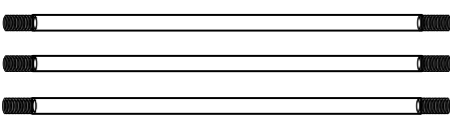
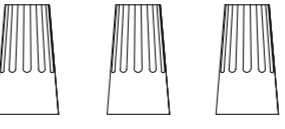
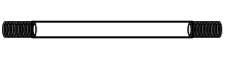
| PIECE | PICTURE | DESCRIPTION | QUANTITY | PIECE | PICTURE | DESCRIPTION | QUANTITY |
|-------|---|--------------------|----------|-------|---|-----------------|----------|
| A |  | Hanging plate | 1X | G |  | Glass lampshade | 4X |
| B |  | Self-tapping screw | 2X | | | | |
| C |  | Ceiling plate | 1X | | | | |
| D |  | M4 nut | 2X | | | | |
| E |  | suspender rods | 3X | O |  | Wire connector | 3X |
| |  | suspender rods | 1X | P |  | wire | 1X |
| F |  | Lamp body | 1X | Q |  | wire | 1X |
| | | | | R |  | Earth wire | 1X |

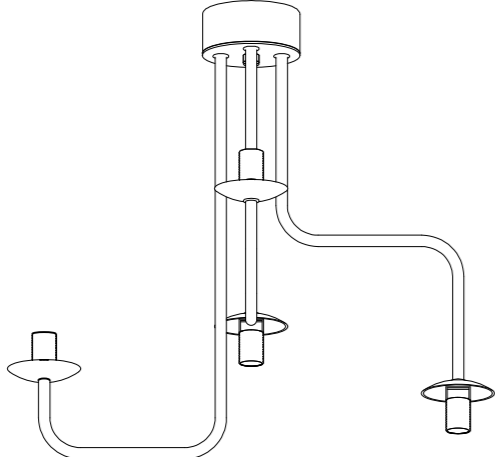
1

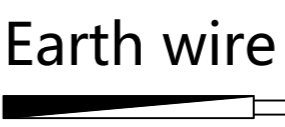
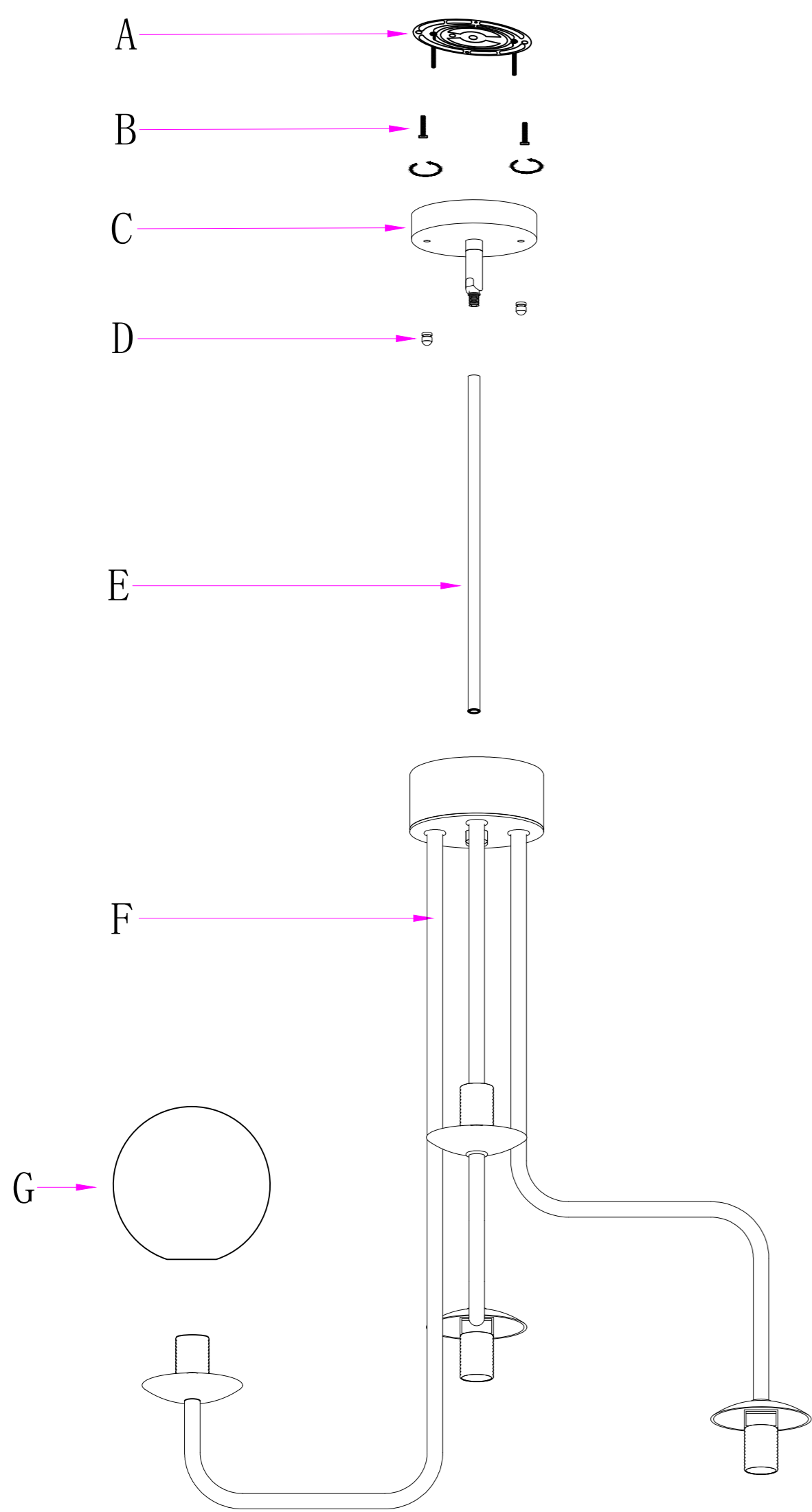

2

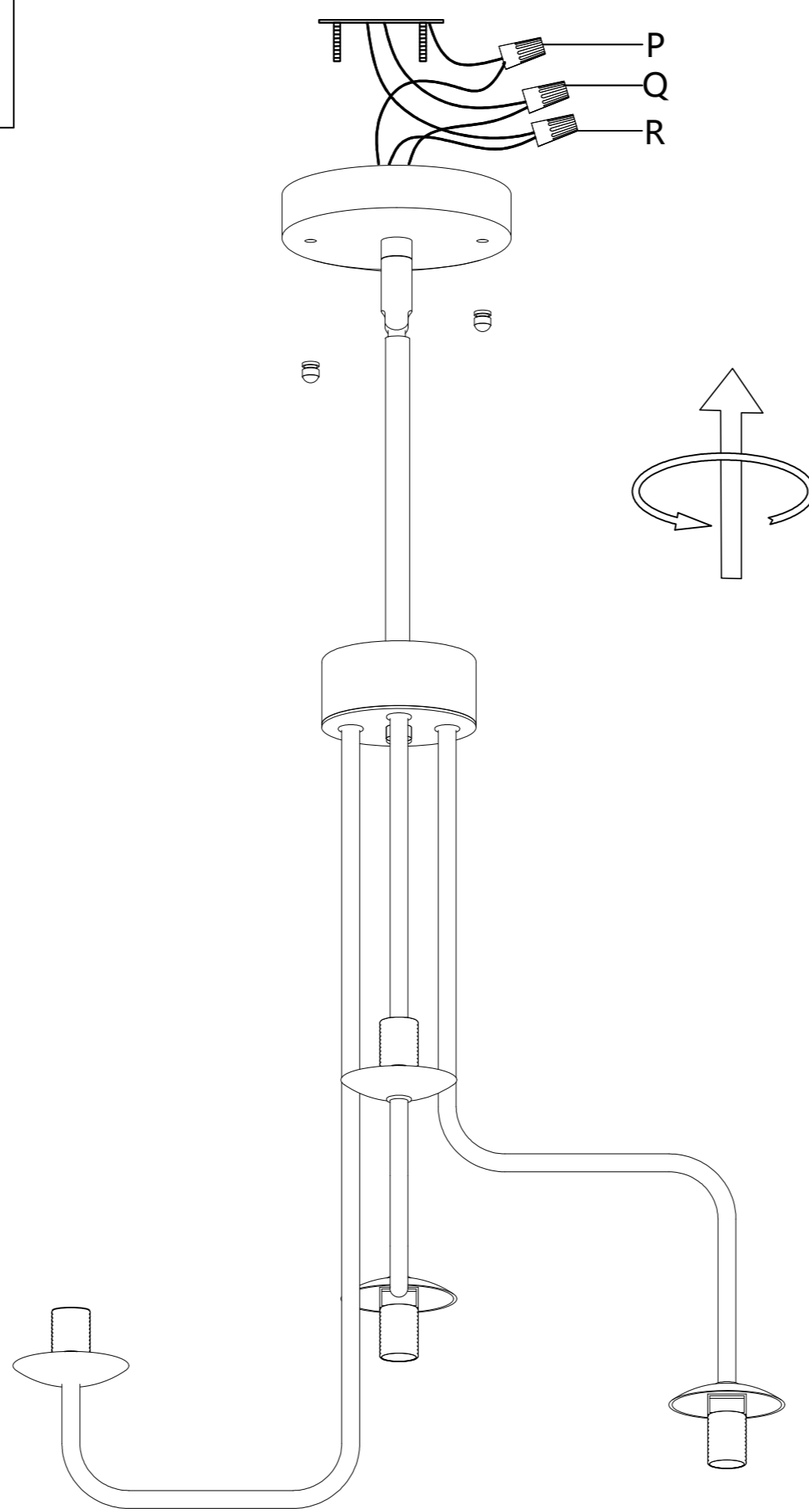

Step 2

1. Connect the power wire of lamp body to the reserved Power cable, pay attention to the positive and negative poles
2. After connecting the wires properly, use M4 nuts (D) to fix the lamp body on the ceiling.

3

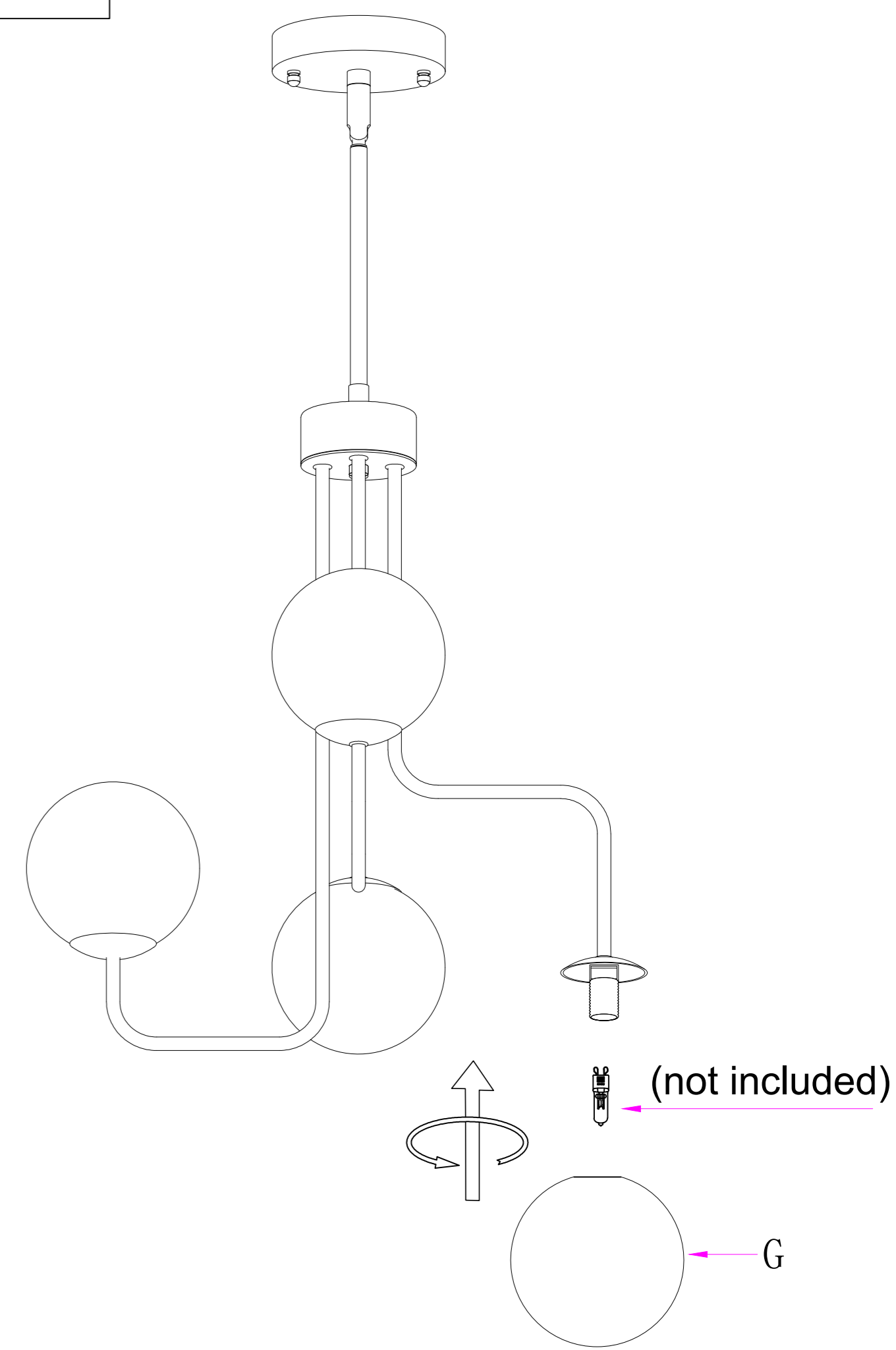

Step 3:

1. Finally, install the G9 light bulb (not included) and glass lampshade (G) to complete the installation.

Step 1:

1. Fix the hanging plate (A) into the ceiling with self-tapping screws (B).
2. Then, connect the suspender rods (E) with the lamp body (F), and the Ceiling plate (C).

Safety Information :

- 1) POWER OFF at the circuit breaker before installation or maintenance.
- 2) INSPECT all parts. Do NOT install and contact us via Message if any are missing or damaged.