

# ASSEMBLY INSTRUCTIONS

**Do not break the bag without reading this manual !**



V-SHAPE SETS  
WITH CUSHIONS\*

# This V shape sofa includes the following:

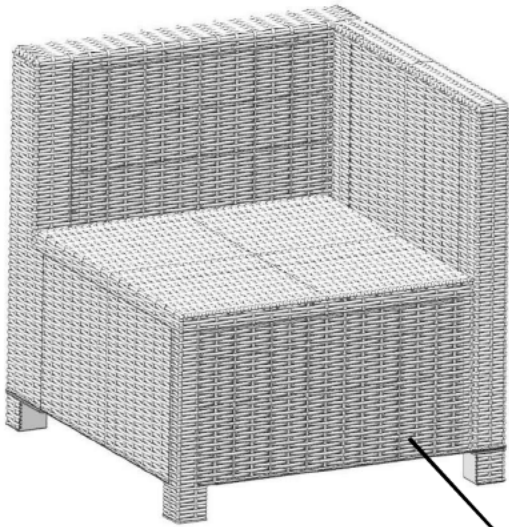

1 Right Arm Chair **Green Bag**

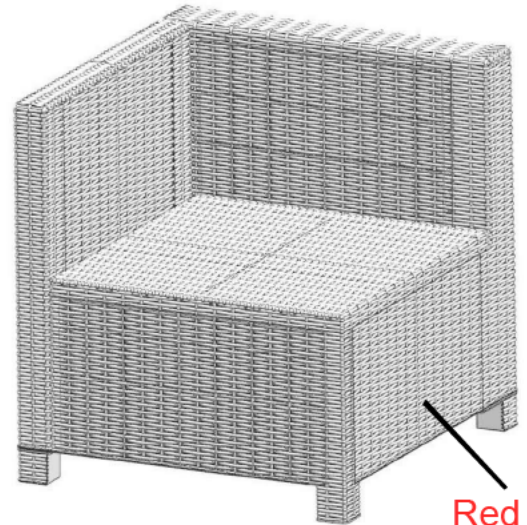

1 Left Arm Chair **Red Bag**

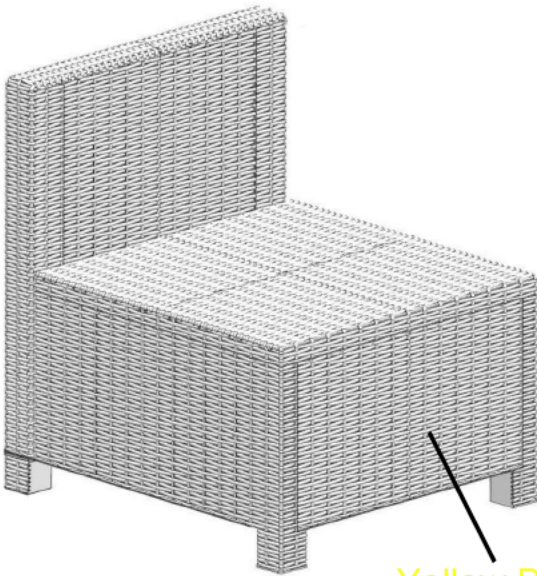

2 Armless Chair **Yellow Bag**

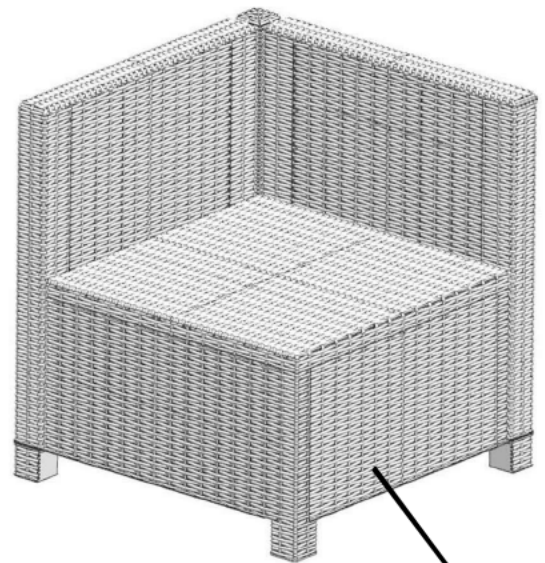

1 Corner Chair **Pink Bag**

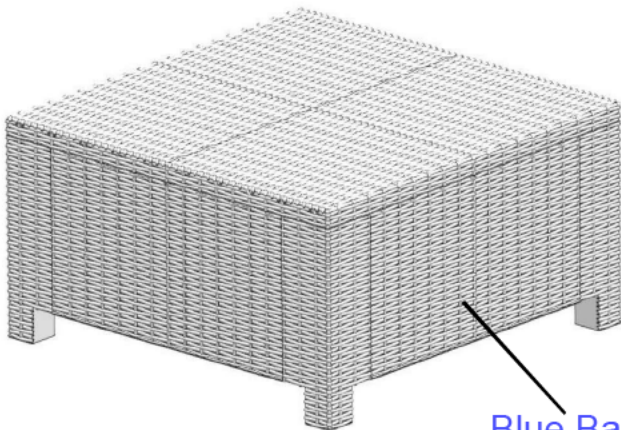

1 Square Coffee Table **Blue Bag**

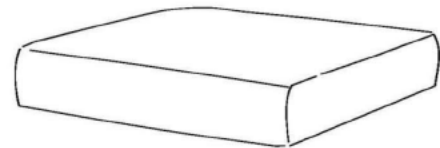



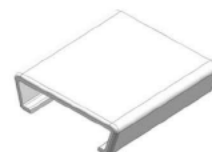



11 Cushions W/Covers

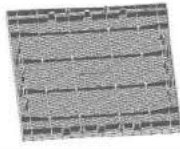
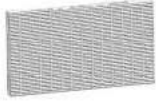

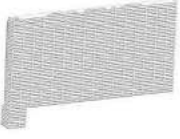
8 Clips

# RIGHT ARM CHAIR ASSEMBLY PARTS

PART	DESCRIPTION	IMAGE	QUANTITY
SB	Seat Board		1
FP	Front Panel		1
BP	Back Panel		1
SP-LS	Left Side Panel		1
RP	Right Panel		1
FT-1	Foot		1
FT-32	Foot		1
FT-34	Foot		1

All parts for this assembly are bagged and sealed with **GREEN** Bag !

# ASSEMBLY

1

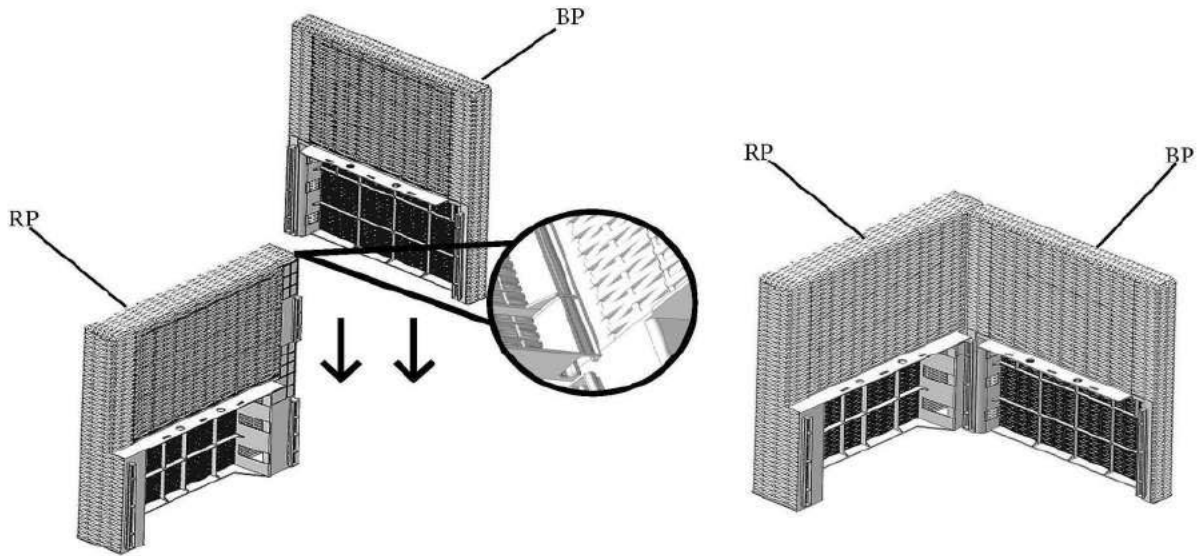

2

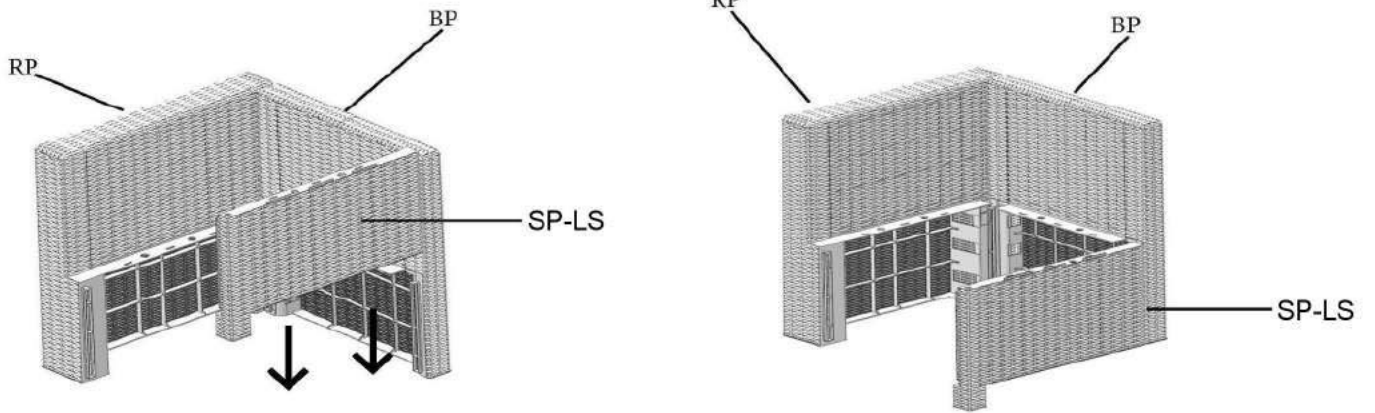

# 3

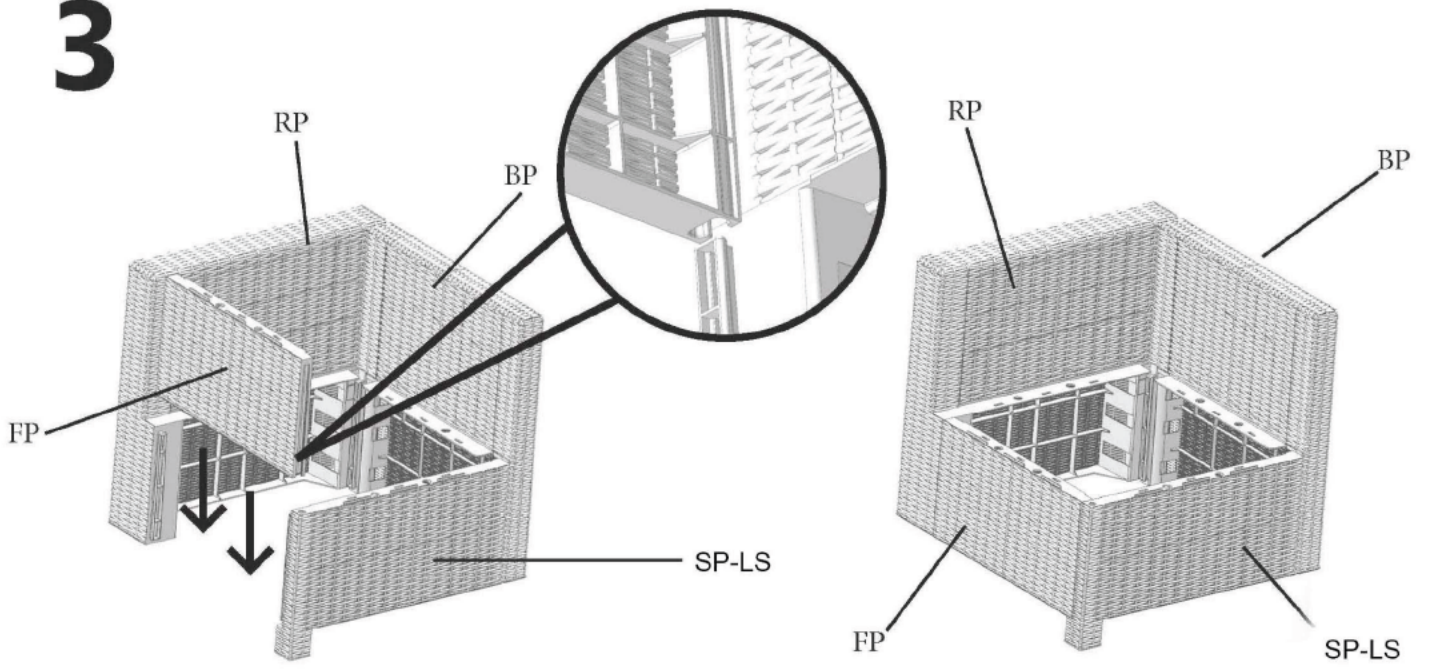

# 4

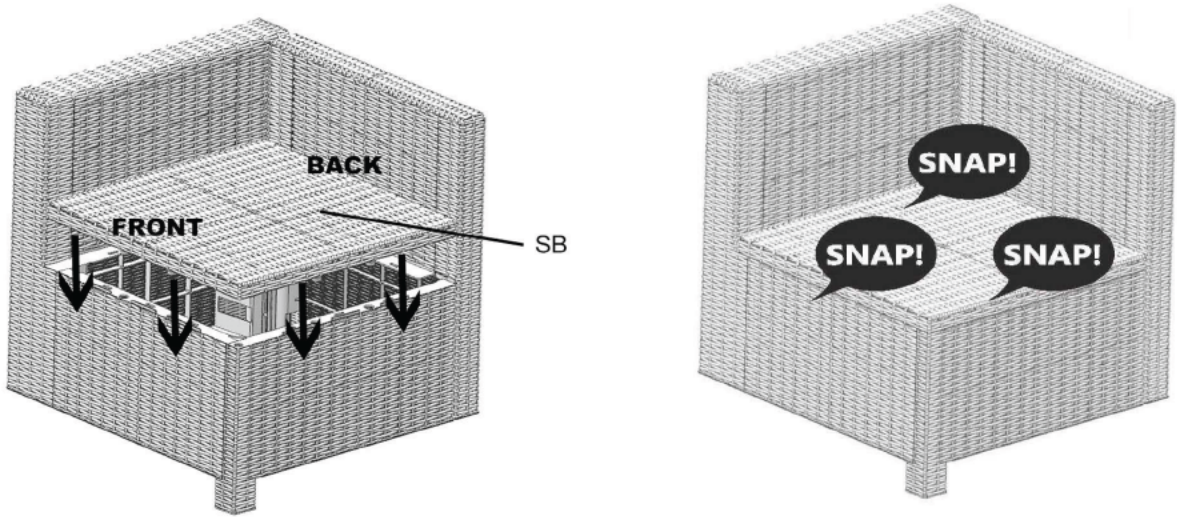



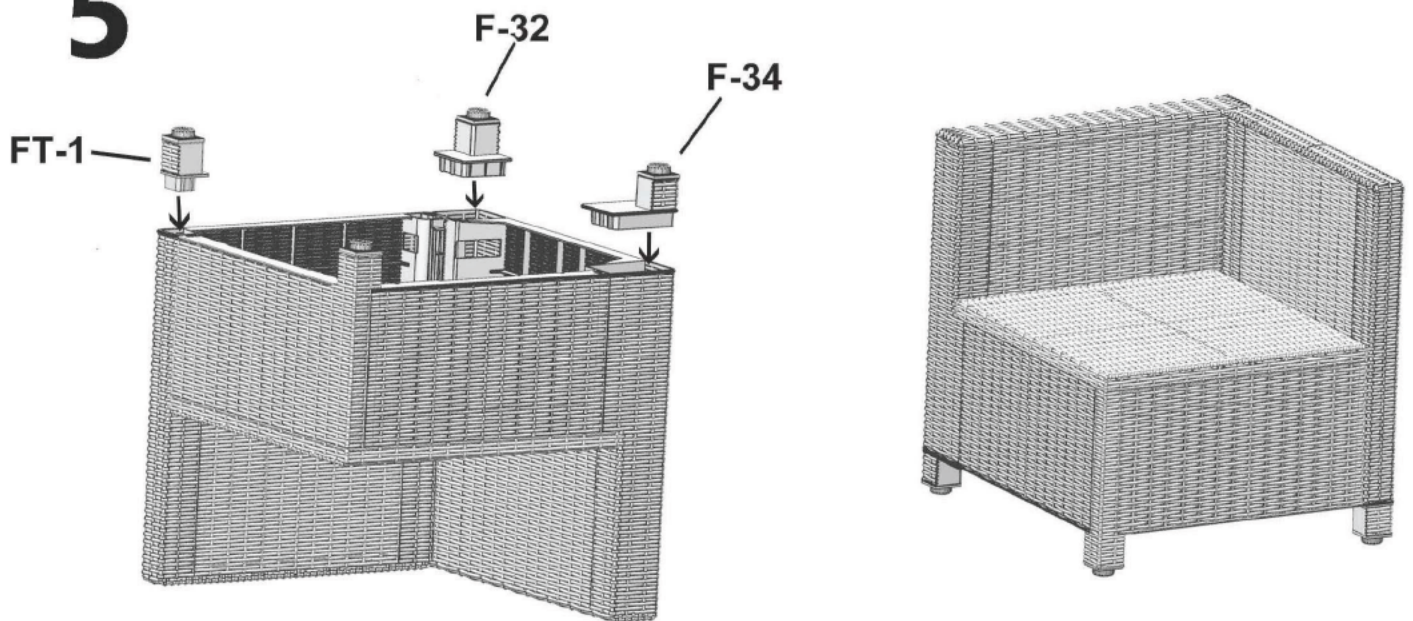

# 5

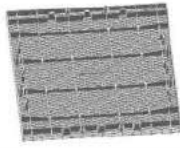
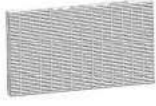

\*Patent pending

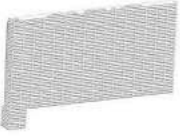
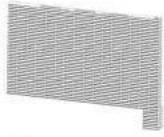
# ARMLESS CHAIR ASSEMBLY PARTS

PART	DESCRIPTION	IMAGE	QUANTITY
SB	Seat Board		1
FP	Front Panel		1
BP	Back Panel		1
SP-LS	Left Side Panel		1
SP-RS	Right Side Panel		1
FT-1/FT-2	Foot		2

All parts for this assembly are bagged and sealed with **YELLOW Bag!**

# ASSEMBLY

## 1

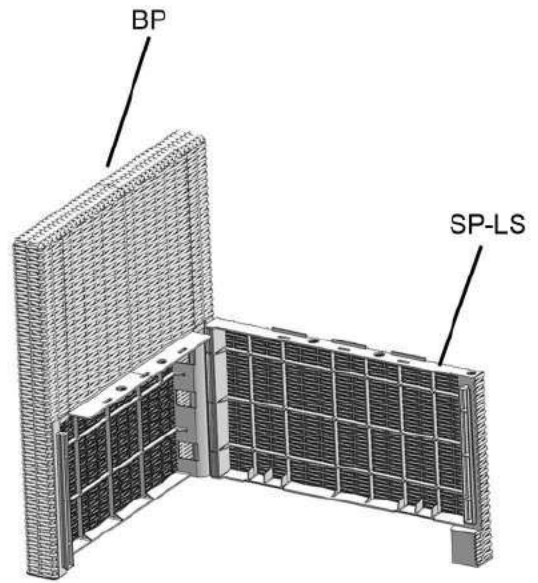
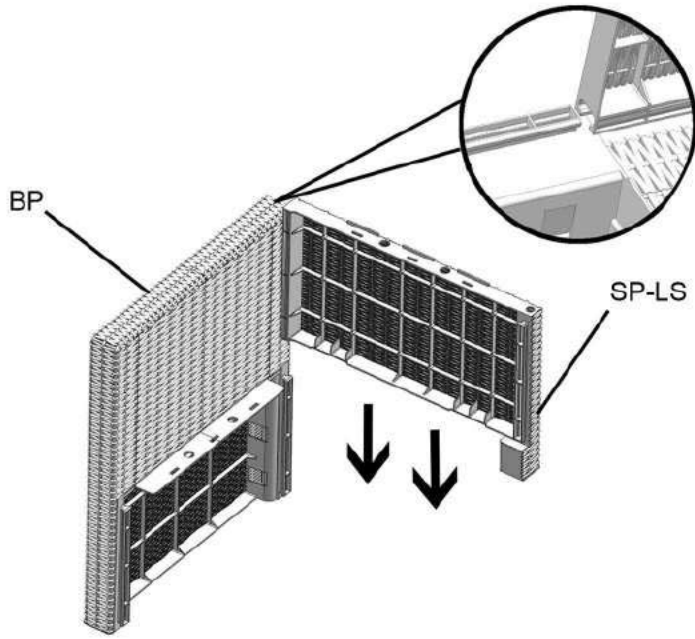

## 2

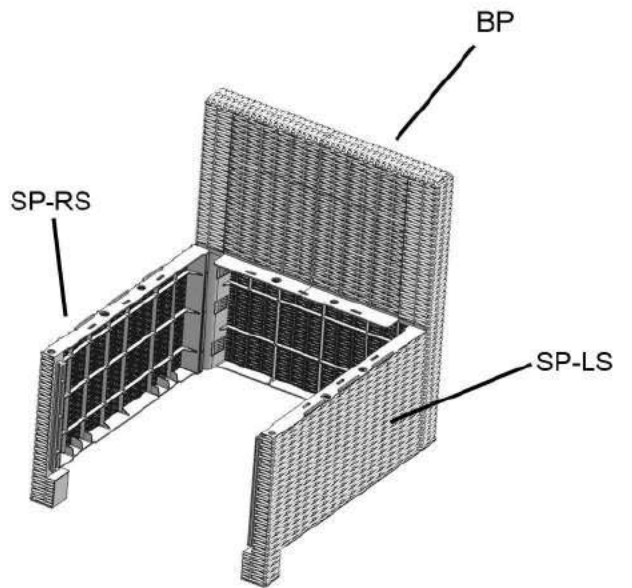
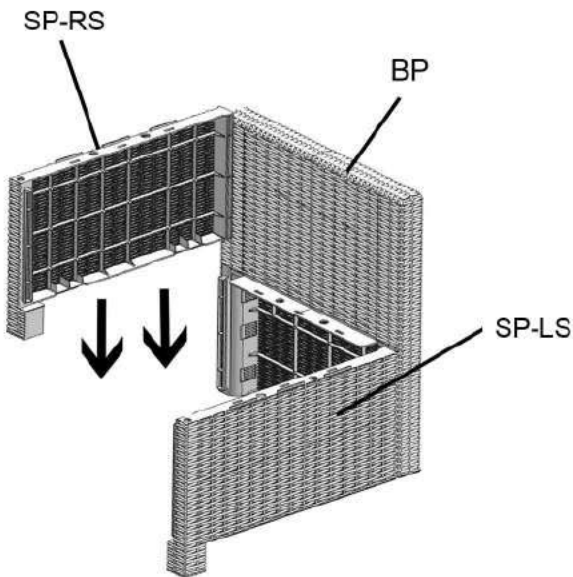

# 3

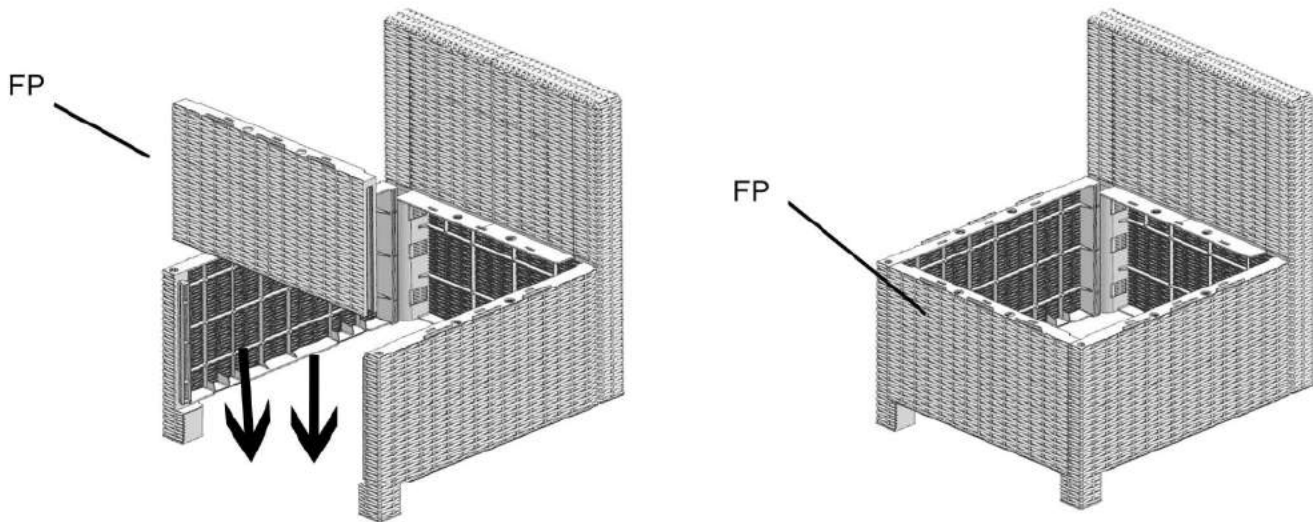



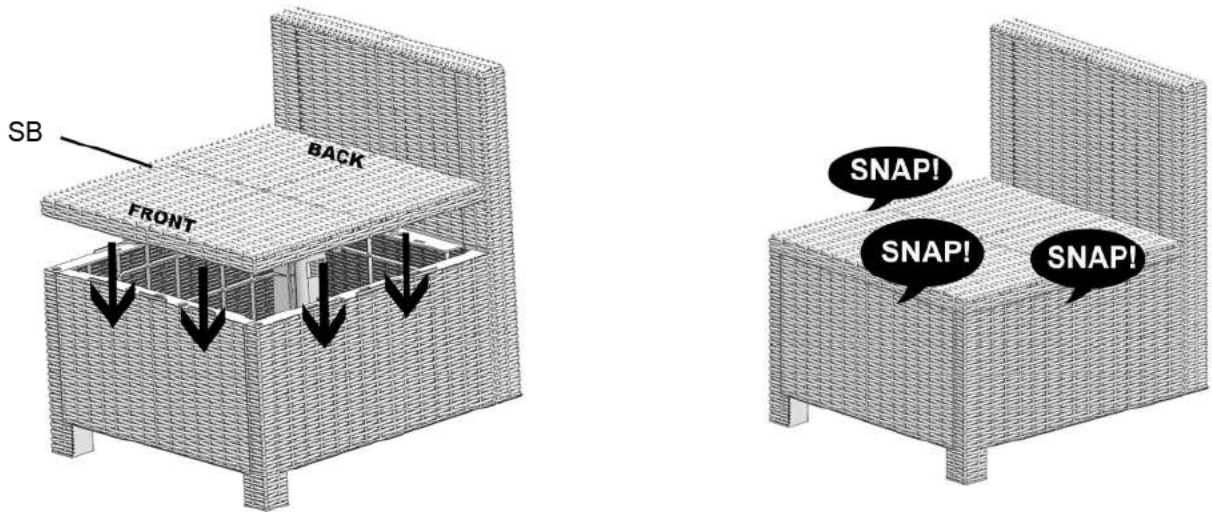

# 4

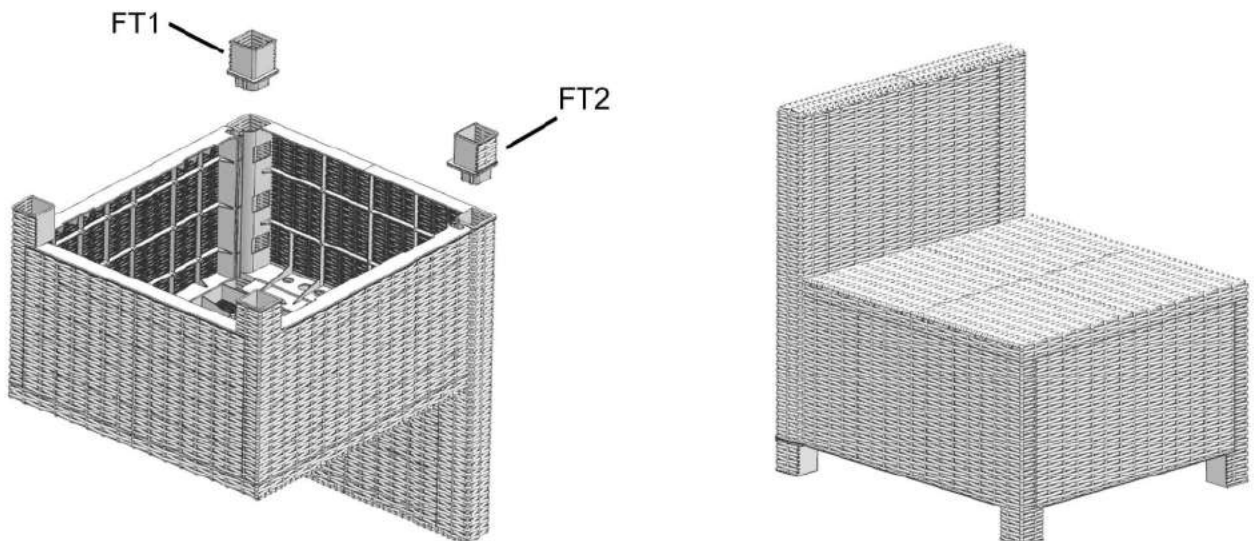

# 5

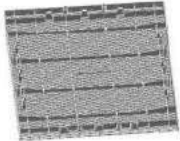
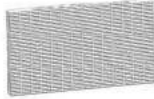
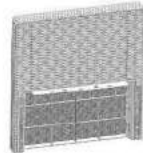
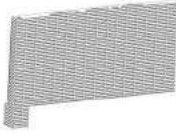

# CORNER CHAIR ASSEMBLY PARTS

PART	DESCRIPTION	IMAGE	QUANTITY
SB	Seat Board		1
FP	Front Panel		1
BP	Back Panel		2
SP-LS	Left Side Panel		1
FT-1/FT-2	Foot		2
FT-21	Corner Foot		1
CC	Corner Connector		1
CTR-2&CTR-3	Corner Connector Part		2

All parts for this assembly are bagged and sealed with **PINK** Bag !

# ASSEMBLY

## 1

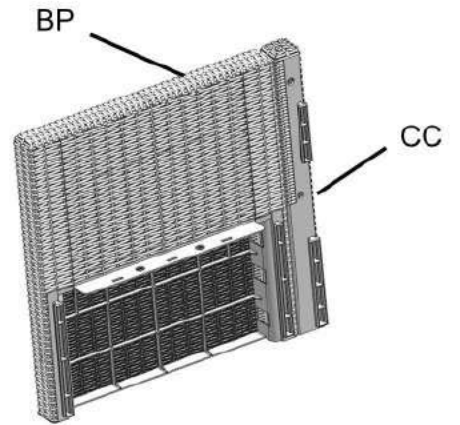
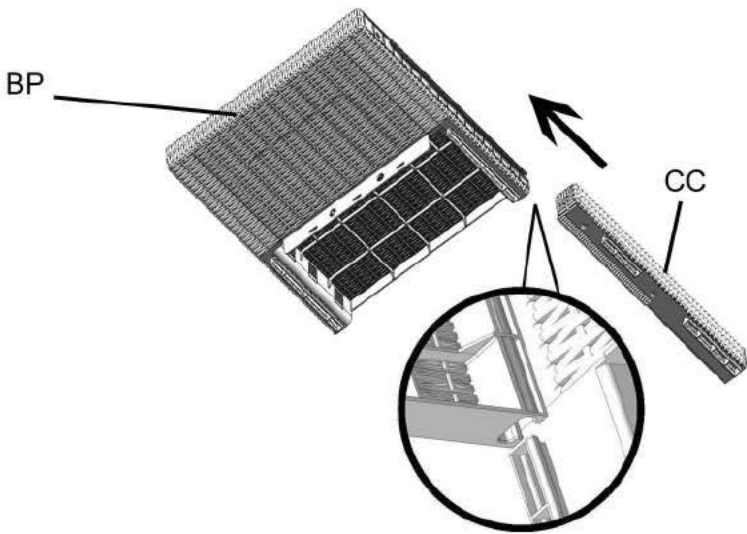

## 2

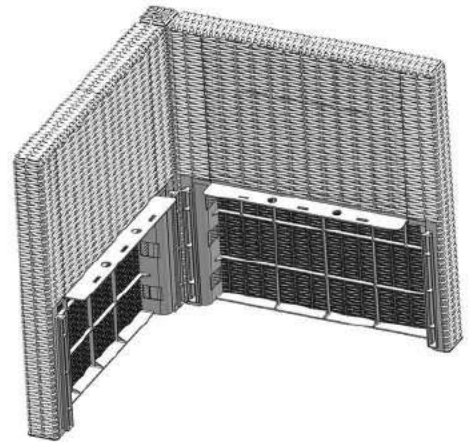
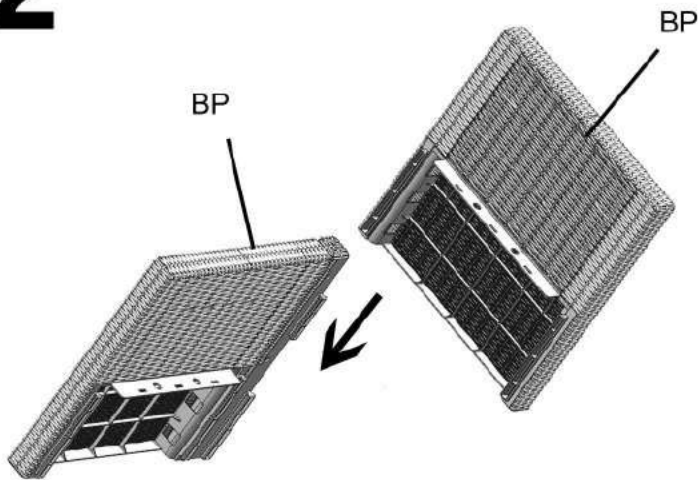

## 3

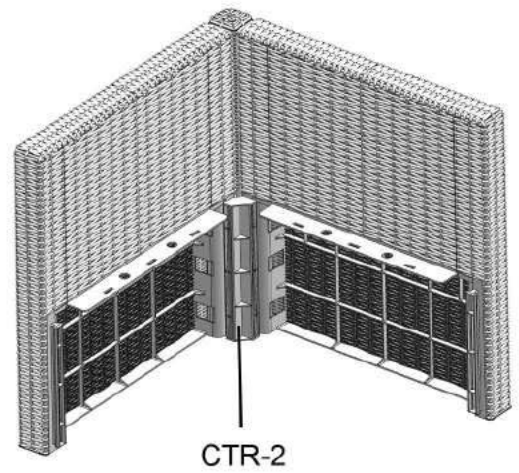
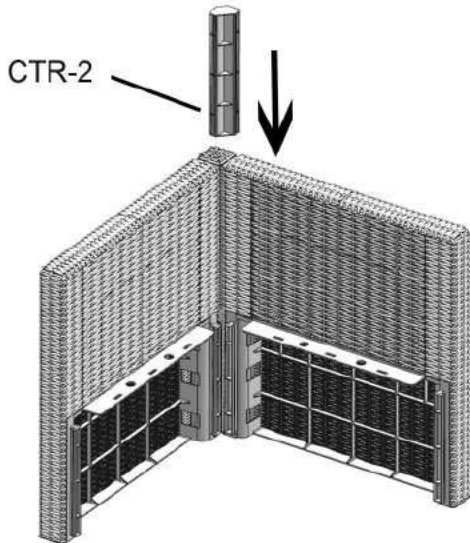

# 4

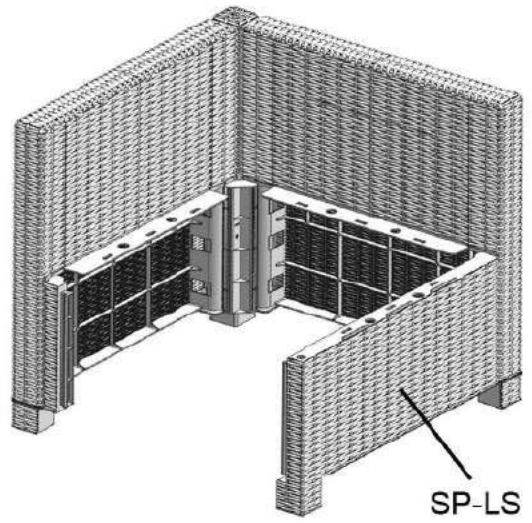
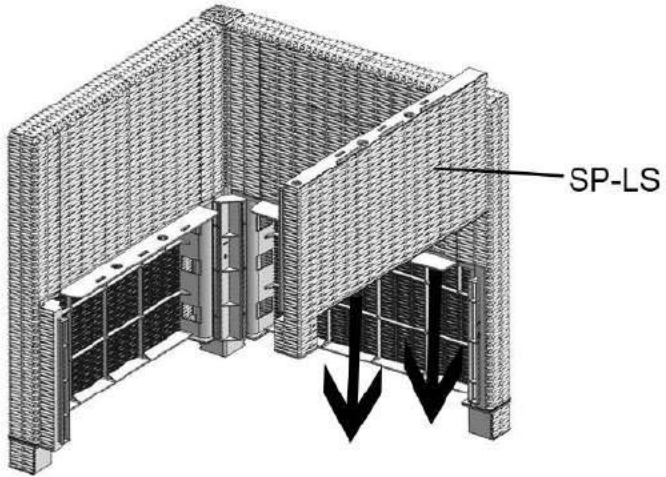

# 5

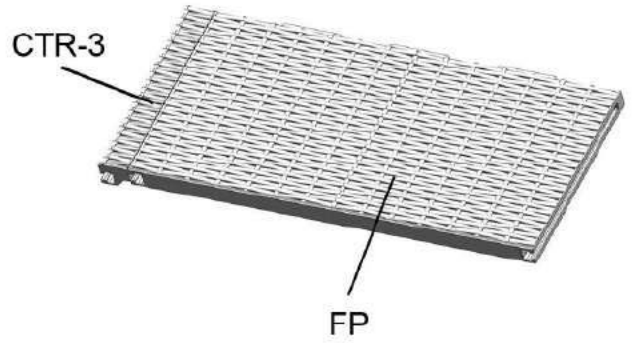
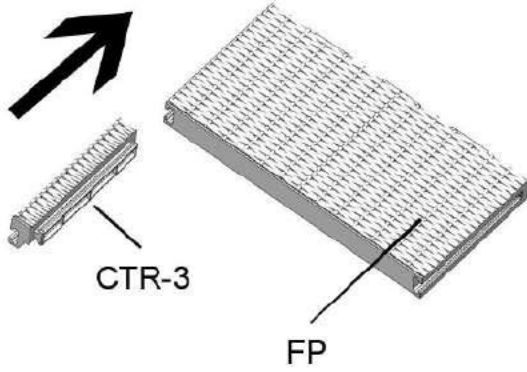

# 6

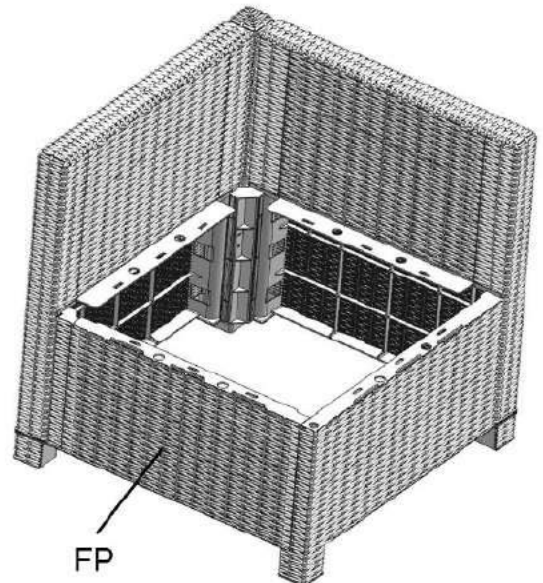
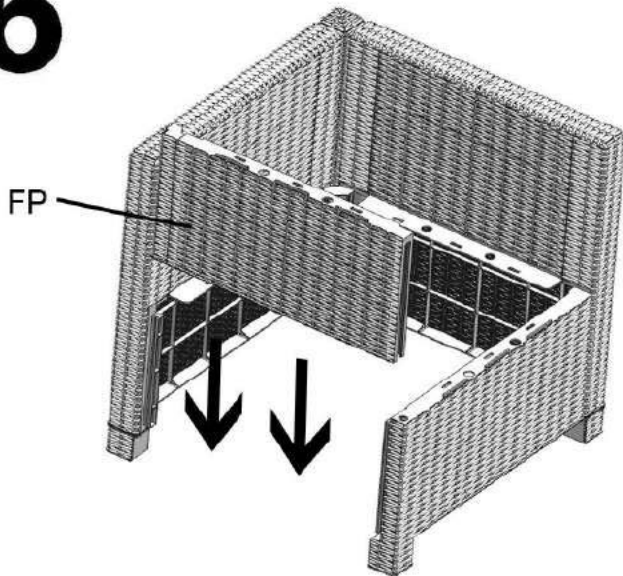



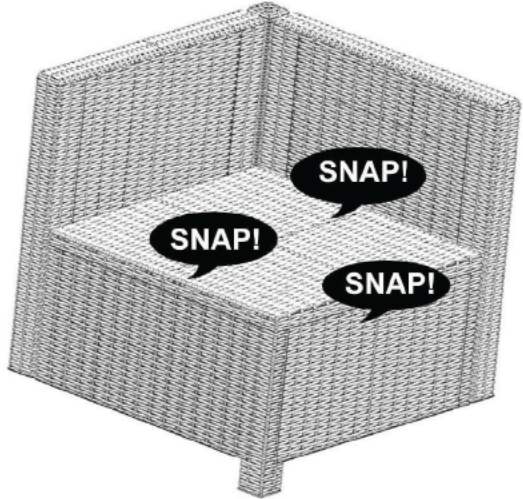
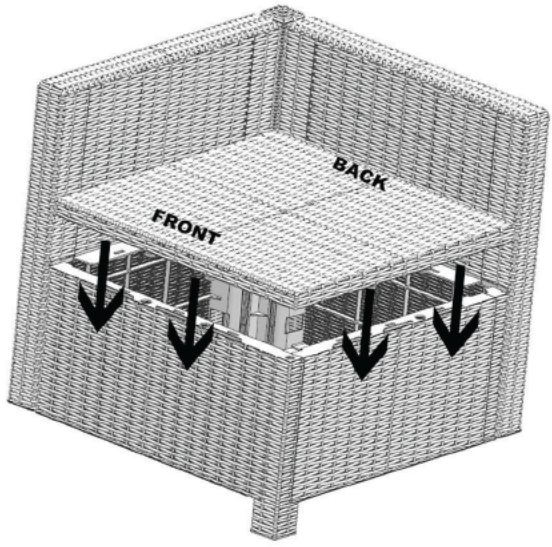

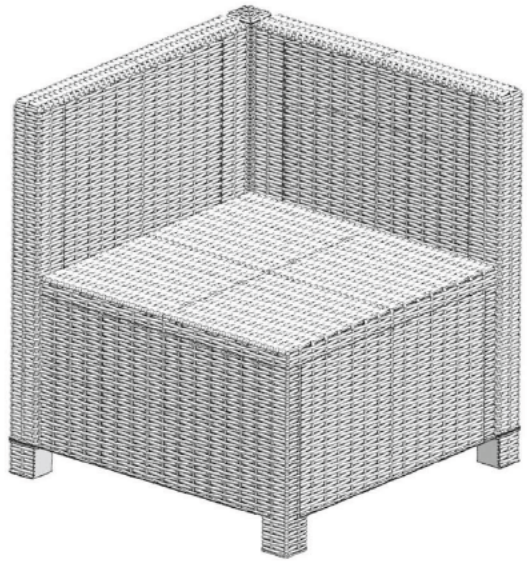
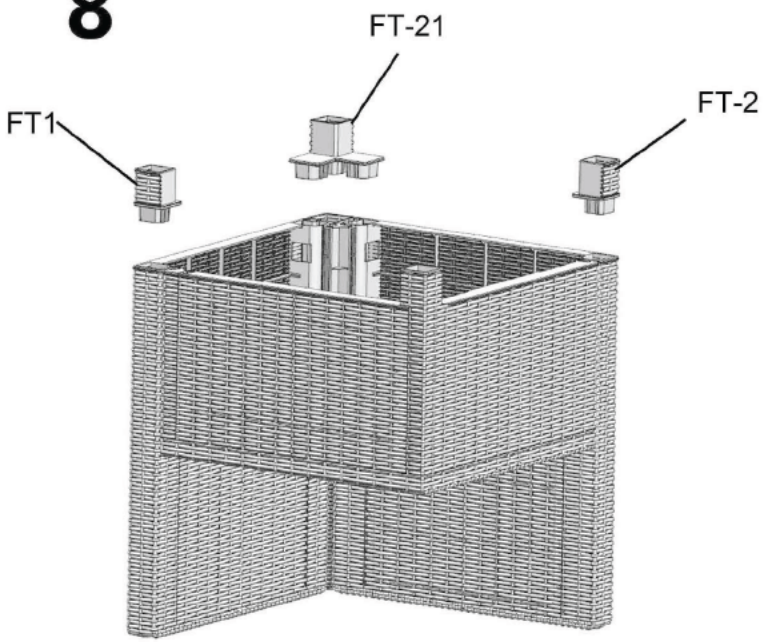

7

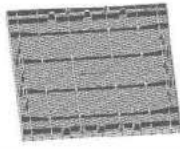
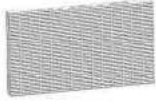

8

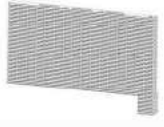
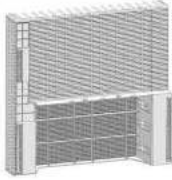

# LEFT ARM CHAIR ASSEMBLY PARTS

PART	DESCRIPTION	IMAGE	QUANTITY
SB	Seat Board		1
FP	Front Panel		1
BP	Back Panel		1
SP-RS	Right Side Panel		1
LP	Left Arm Panel		1
FT-2	Foot		1
FT-31	Foot		1
FT-33	Foot		1

All parts for this assembly are bagged and sealed with **RED Bag !**

1

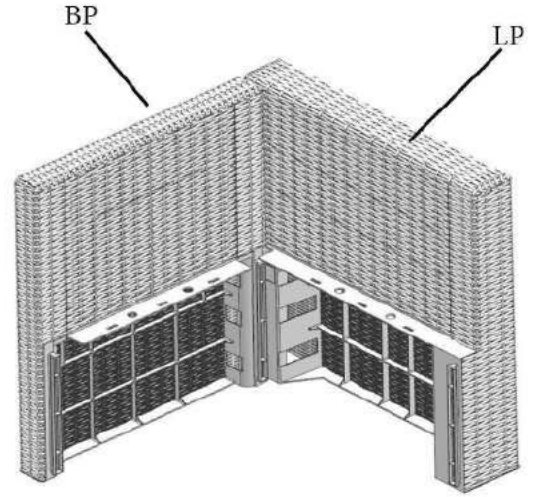
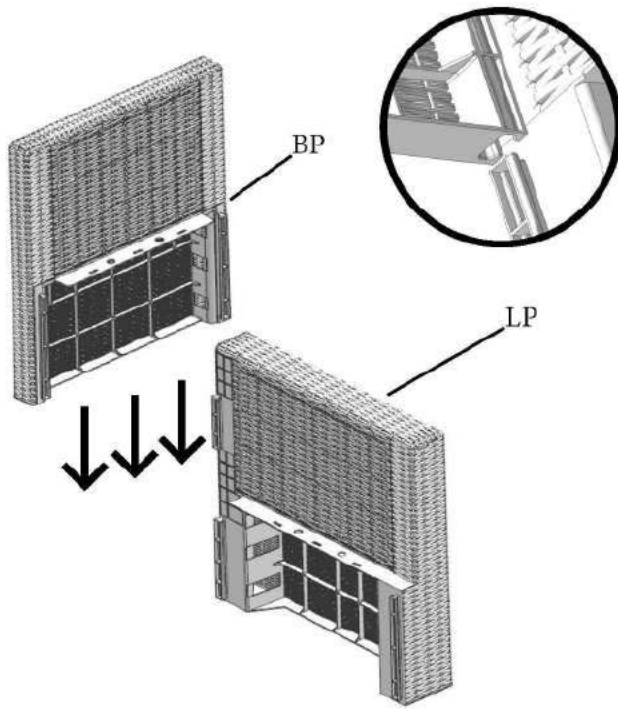

2

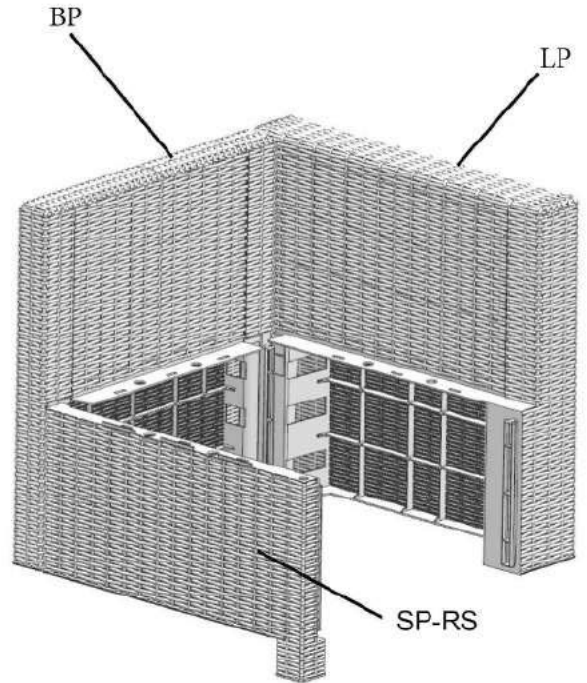
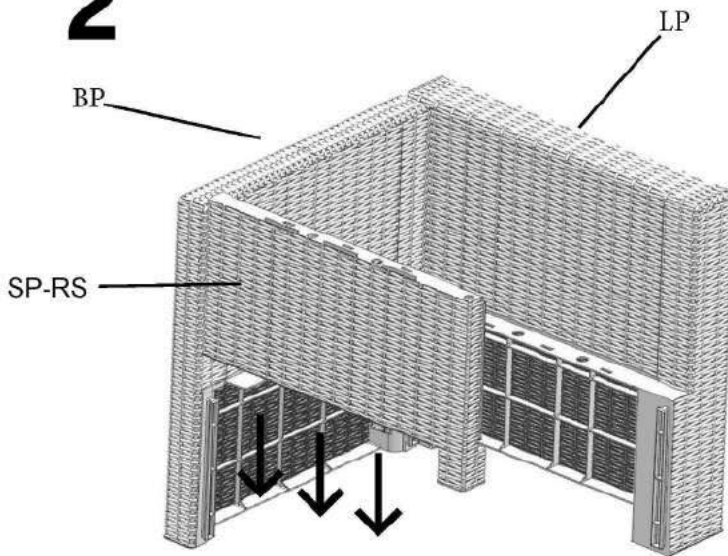

# 3

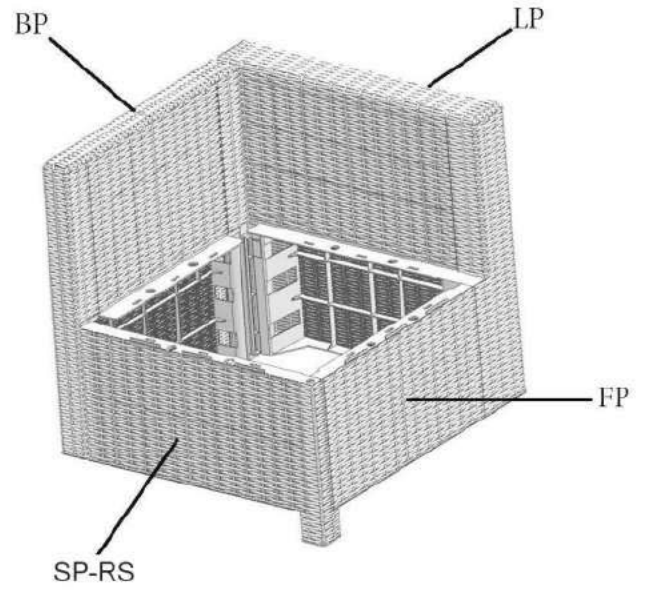
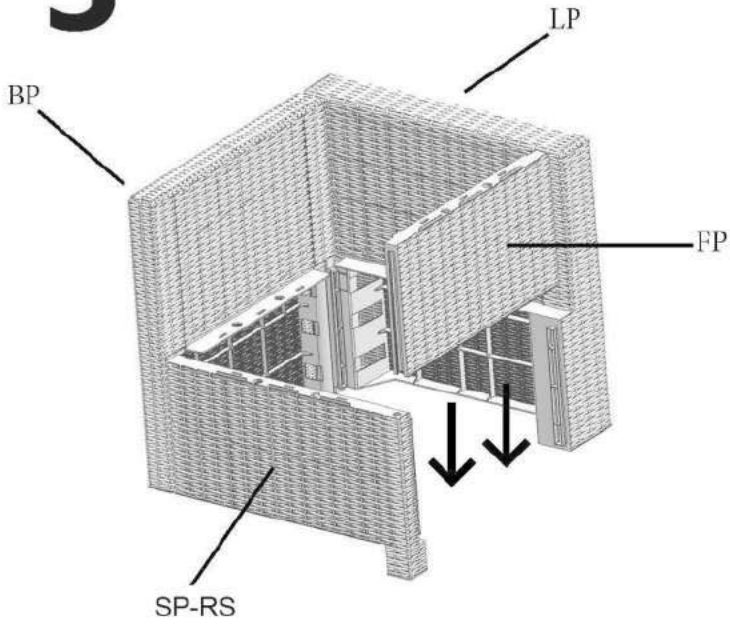

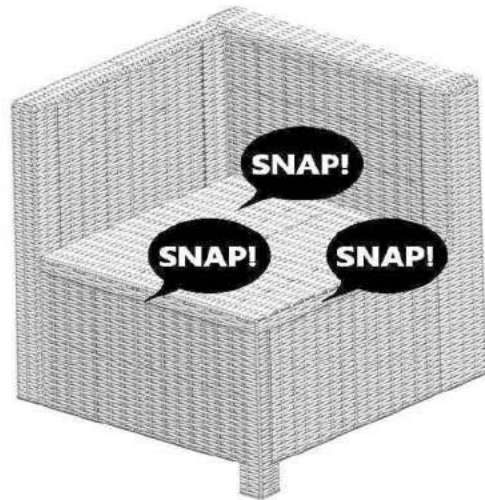
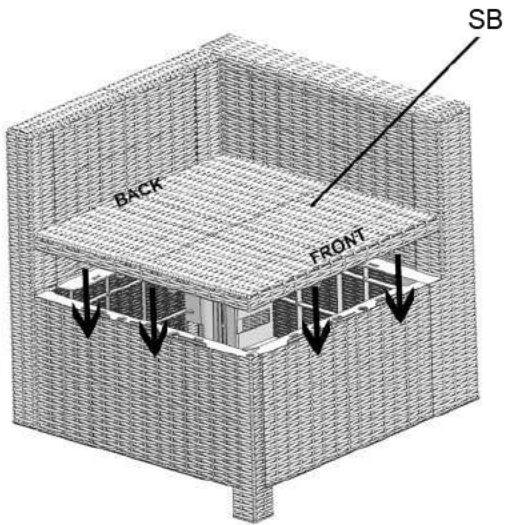

# 4

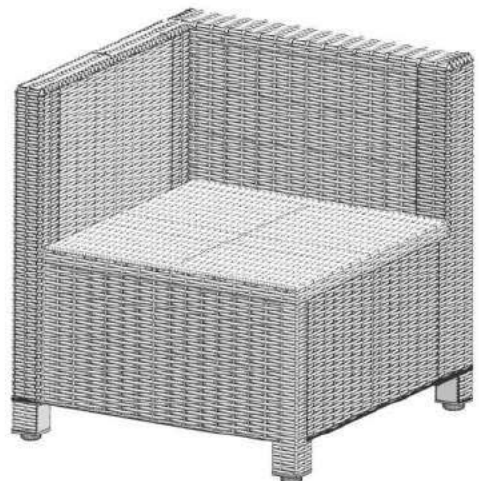
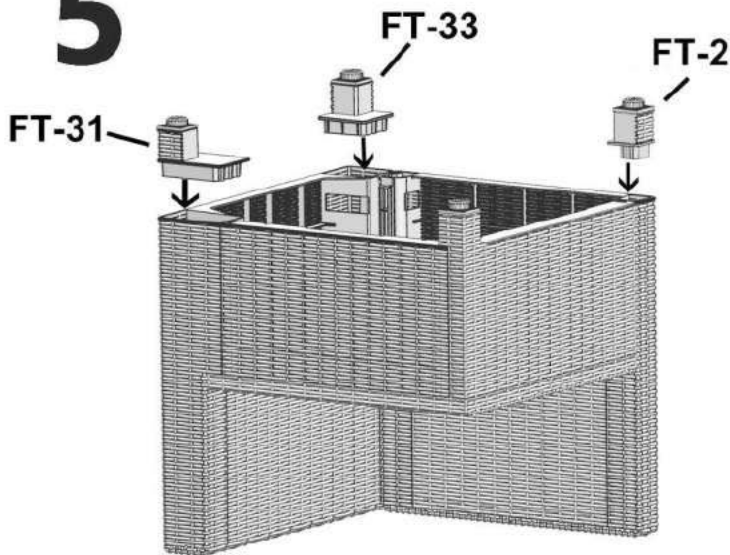

# 5

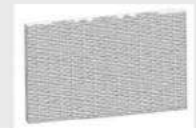

# SQUARE COFFEE TABLE ASSEMBLY PARTS

PART	DESCRIPTION	IMAGE	QUANTITY
SC-TP	Table Top		1
FP	Front Panel		4
CTR-LG	Coffee Table Legs		4

All Parts for this assembly are bagged and sealed with **BLUE** Bag !

# ASSEMBLY

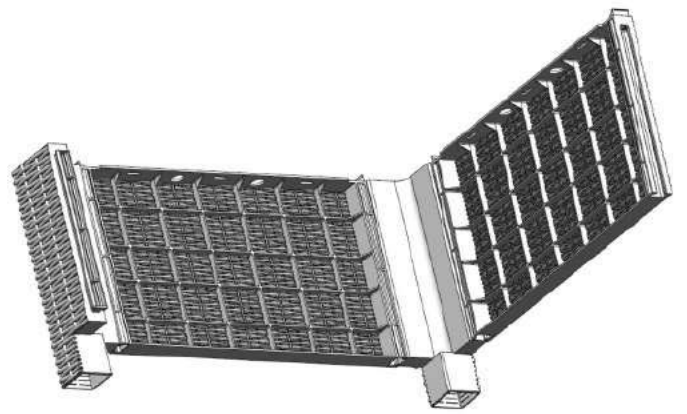
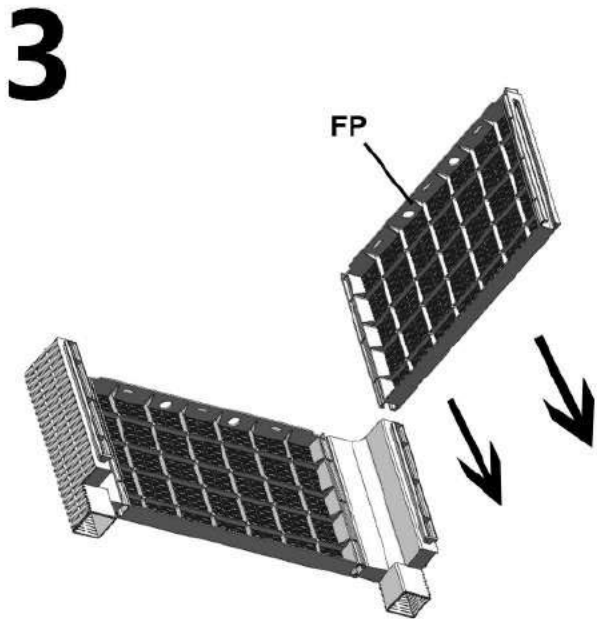
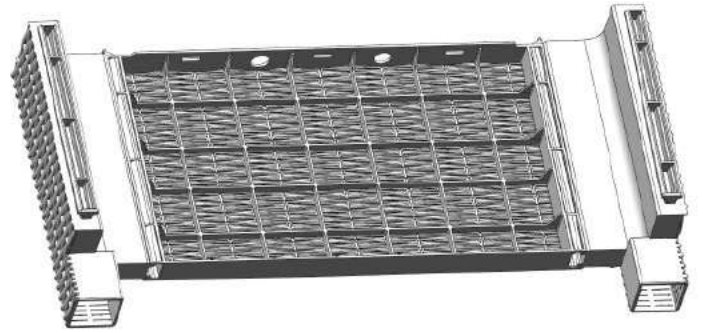
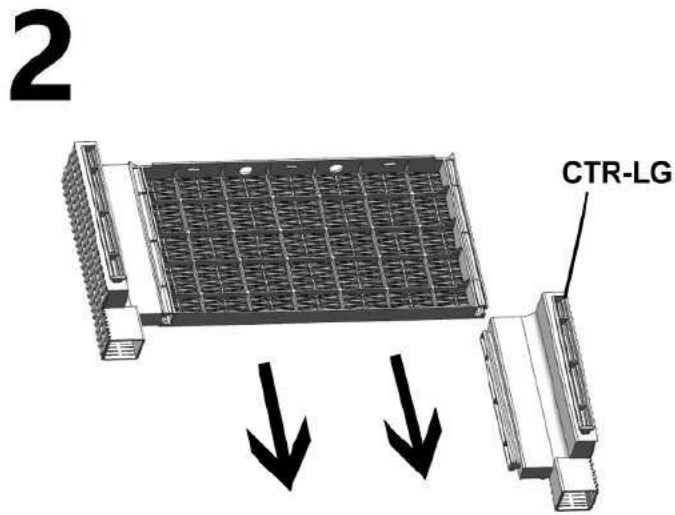
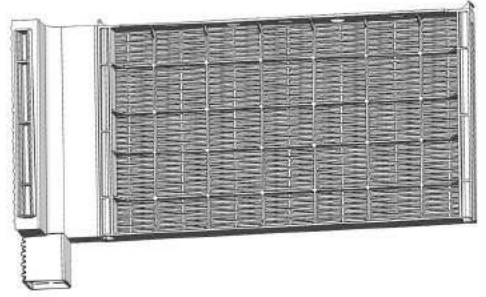
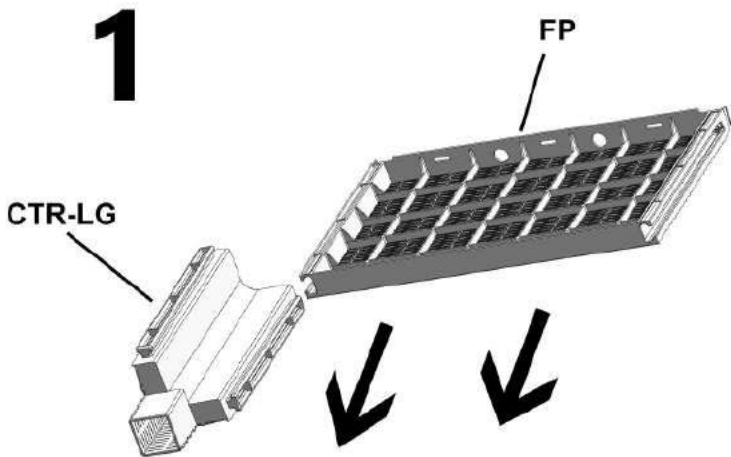

4

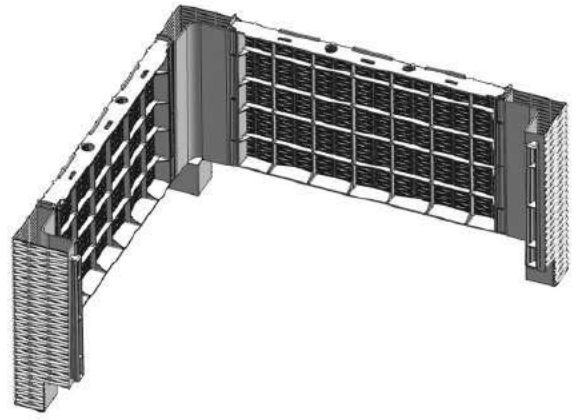
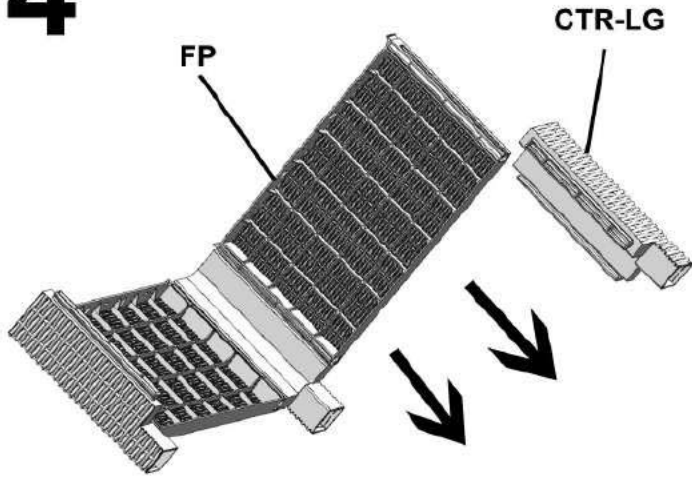

5

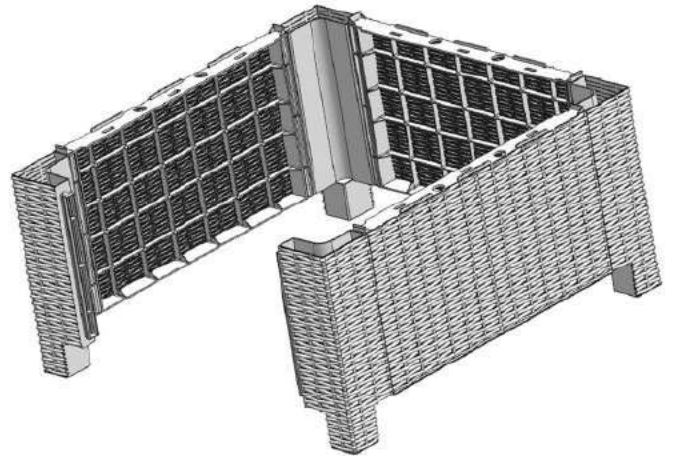
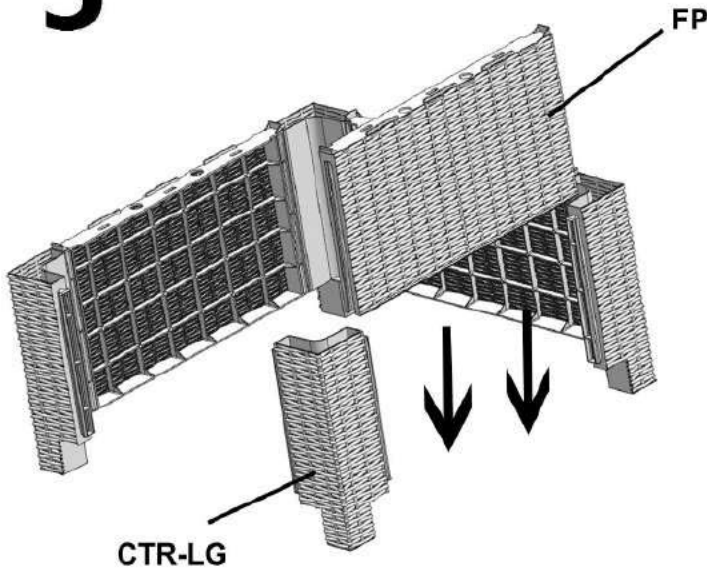

6

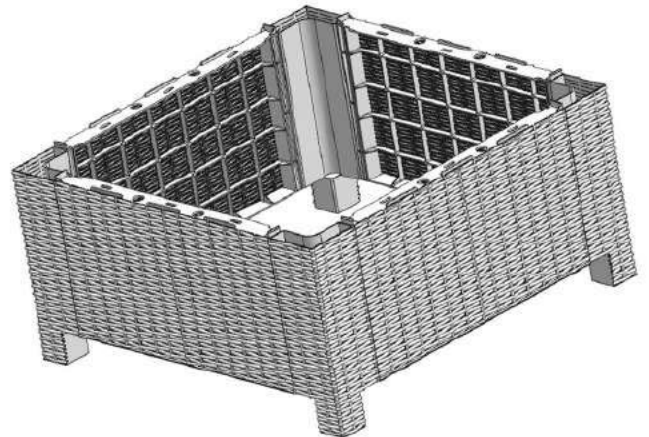
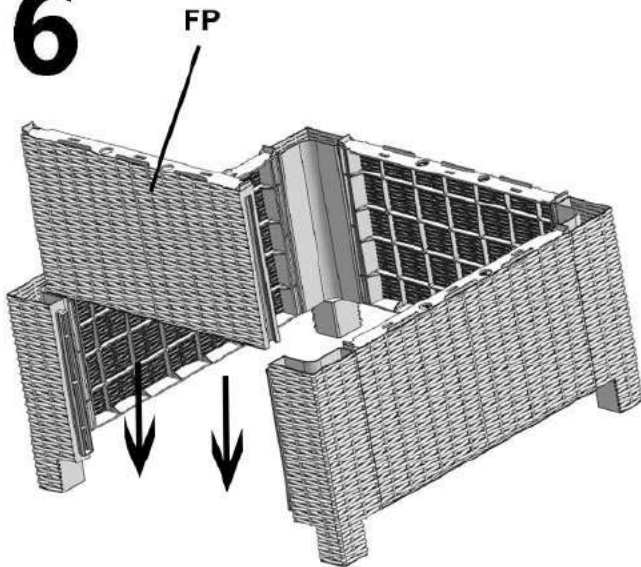

# 7

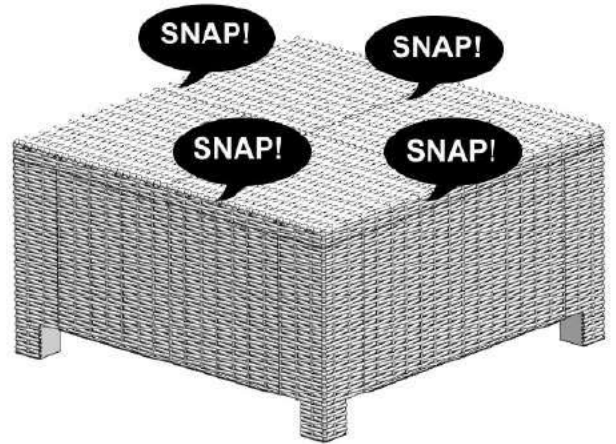
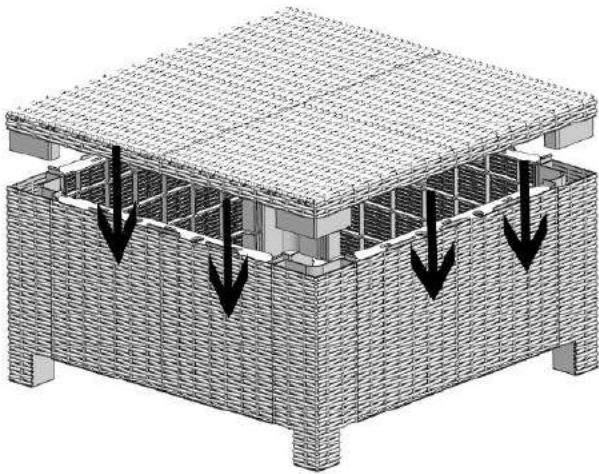

# CLIP ASSEMBLY

If you need to keep all assembly together , use the clips to assemble.  
Please see as below:

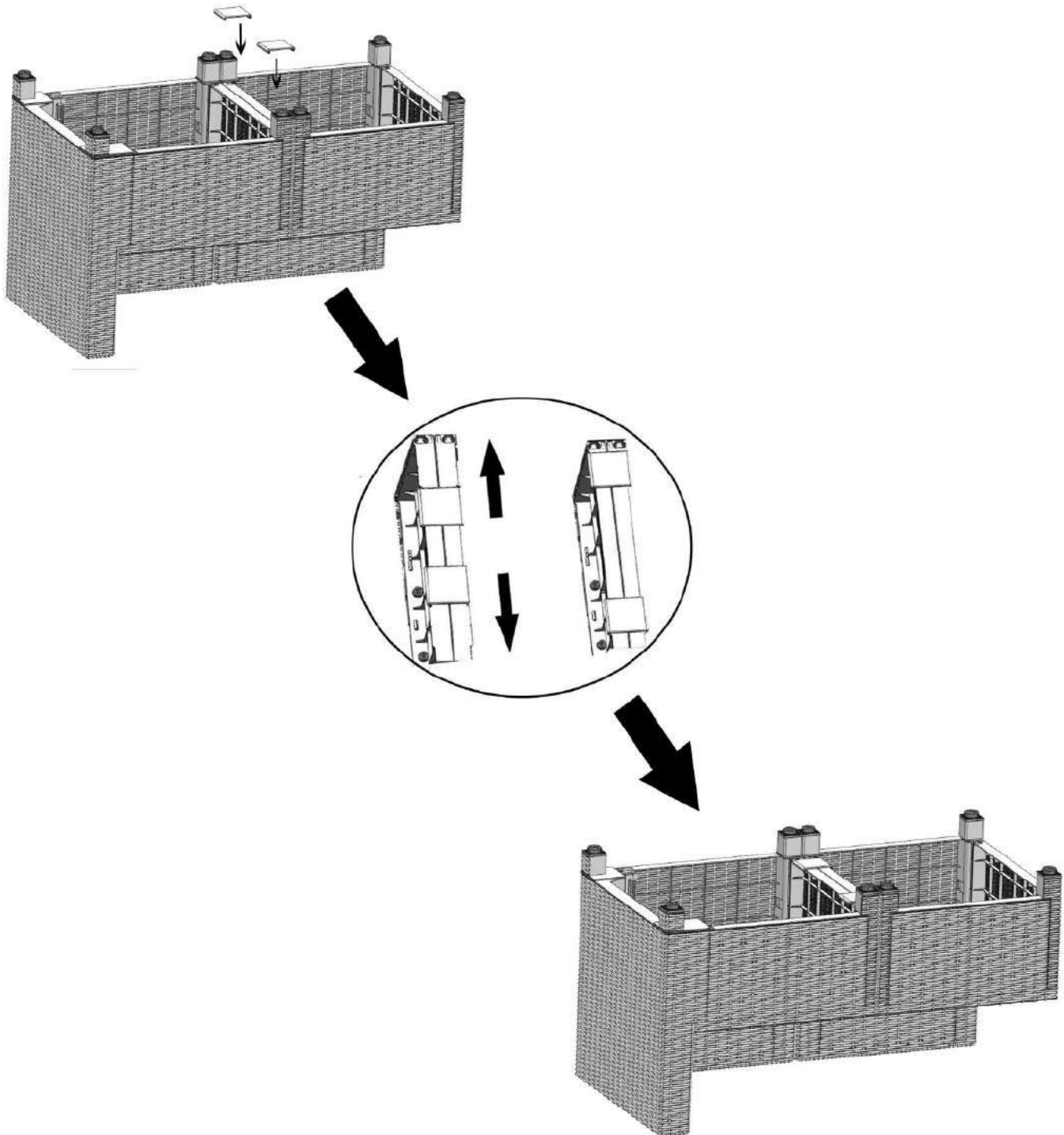

# RETAINER COVER ASSEMBLY



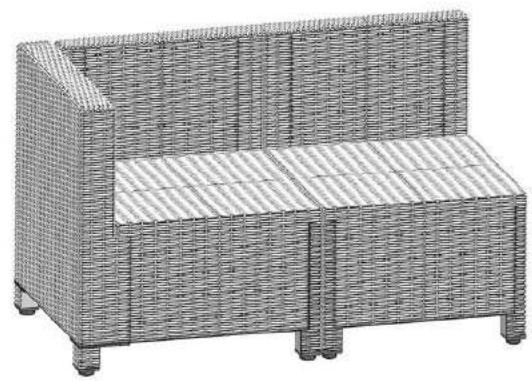
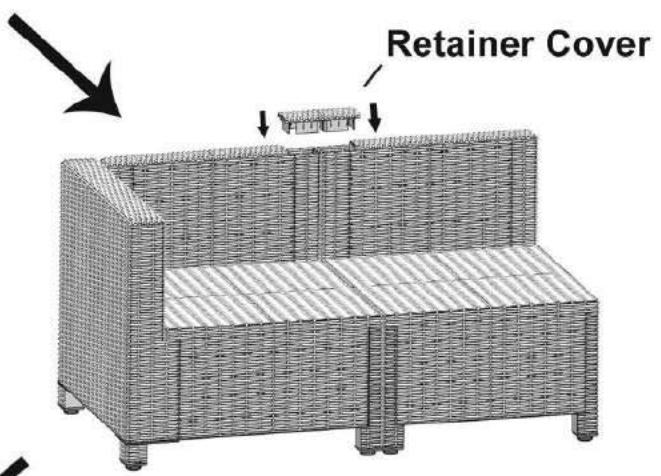
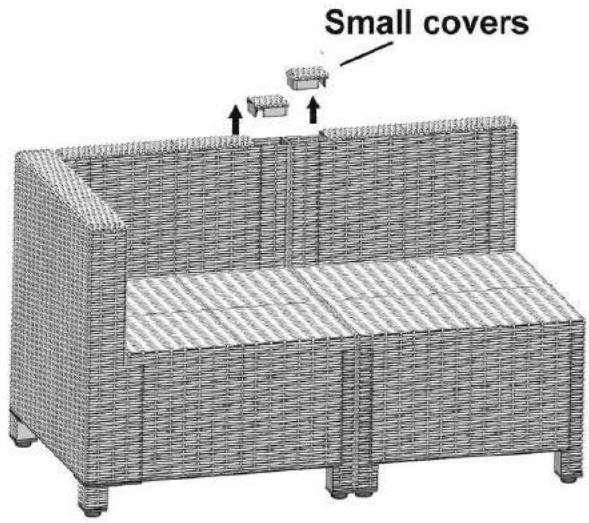







In order to retain/combine 2 chairs together, please remove the small covers as shown and replace it with a "Retainer Cover"



Replace small covers with the retainer cover in these places as required.



## Care & Maintenance

- ⊘  ● Do not put hot items directly on furniture surface.
  - ⊘  ● Do not clean furniture with harsh cleansers or polish.
  - ✓  ● To obtain the longest lifespan of your outdoor products, minimizing exposure to direct sunlight is recommended.
  - ⊘  ● Children should not climb or jump on the furniture.
  - ⊘  ● Do not write on furniture without a padded barrier to protect the surface.
  - ✓  ● To obtain the longest lifespan of your outdoor products, avoid extended and lengthy exposure to rain, snow, and direct sunshine. Whenever possible cover the product and /or place under patio or awnings.
  - ⊘  ● Not for commercial use. For residential use only.
  - ⊘  ● Stains may be removed with mild soap solution and damp cloth.
  - ✓  ● Keep away from sources of ignition.
- 
- ✓  ● Dust and pick-up spills using a clean, non-colored, lint-free cloth.