

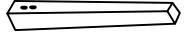



ASSEMBLY INSTRUCTIONS

Dimension : 54"L x 54"W x 36"H

Description : TABLE

LIST OF PARTS			
A	TABLE TOP		1PC
B	TABLE LEG		3PCS

LIST OF HARDWARE				
D	BOLT		φ 5/16" x 63.5mm	6 PCS
H	LOCK WASHER		φ 5/16 "	6 PCS
E	WASHER		φ 5/16 "	6 PCS
F	WRENCH		12 mm x 90	1 PC

STEP 2

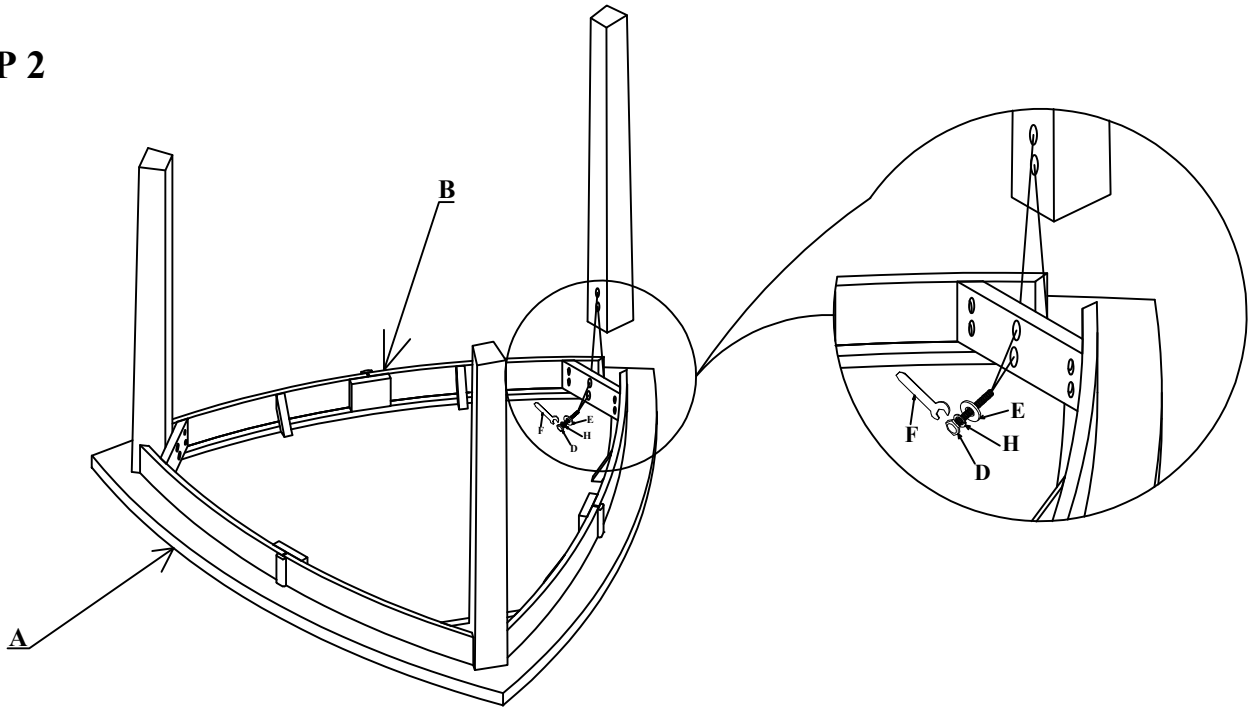

STEP 2

