

INSTRUCTIONS MANUAL



PATIO SOFA

Loosely assemble before tightening.

IF YOU PURCHASED THE PRODUCT ONLINE AND HAVE ANY
QUESTIONS OR CONCERNS
PLEASE CONTACT US

Warning:

1. Very important!

After receiving the product, please check if all parts are intact.

Do not open the vacuum-sealed packaging of the mat immediately.

Only proceed with opening the packaging if you are satisfied with the product.

2. When unpacking the box, please use tools carefully to avoid scratching the mat.

Note: Since the mat is vacuum-packed, if you are not satisfied with the product after opening, it may affect the after-sales process.

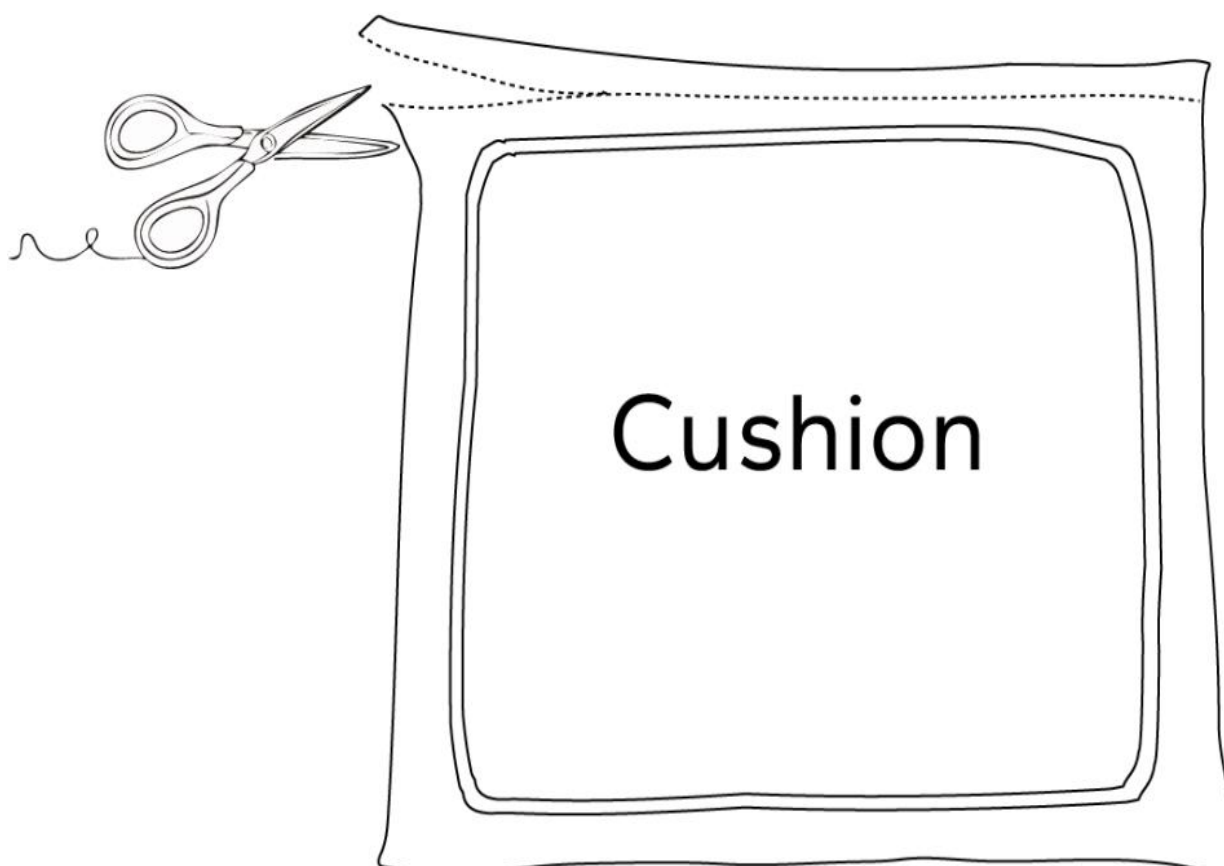

Warning and Cautions:

Thank you for choosing our furniture. Please read and understand this entire manual before attempting to assemble or install the product.

GENERAL BEST PRACTICES FOR ASSEMBLY

1. Familiarize yourself with the product and check all parts against the packing list. If any Parts are missing or damaged, do not install. Contact us immediately.
2. Some parts may contain sharp edges. Wear protective gloves, if necessary, during assembly.
3. Check all nuts and bolts periodically for tightness and, when required, tighten them again.
4. Pay attention to the parts orientation.
5. Save all packing materials until assembly is complete to avoid accidentally discarding smaller parts or hardware.

IMPORTANT

- Make sure to place the washer on the bolt before inserting it into the bolt hole.
- To ensure the best fit, assemble loosely before tightening.
- Tighten all bolts after all parts are assembled.

WARNINGS

 **Keep children and pets away from the working area during assembly and adjustments.**

1. Keep the assembly area at least 6 feet from any obstruction, such as a fence, garage, house, overhanging branches, laundry lines, or electrical wires.
2. When assembling and using this product, always follow basic safety precautions to reduce the risk of personal injury and product damage. Please read all instructions before assembly and use.
3. Check all bolts for tightness before use. **IMPORTANT** - check and tighten bolts often to keep them secure!
4. The chair is not to be used for standing purposes and will not function as a stool or step-ladder. Use on even surfaces only.
5. The chair supports a weight of 750lb (341 kg). Improper use of this product or failure to use it as directed may result in injury. Not intended for commercial use.

WARRANTY

•WHAT IS COVERED?

- The limited warranty is extended to the original purchaser and covers material and manufacturing defect, provided the item is properly maintained and used for personal residential purposes only.
- Warranty: 180 DAYS.
- Lost Accessories or Parts Policy: Costs for lost accessories or parts will be charged after 90 days from the date of purchase.

MAINTENANCE

- STAIN RESISTANT CUSHIONS CARE:** Keep cushions in storage on rainy days.
- SPILLS:** Immediately wipe up spills using a white damp cloth. Repeat if necessary until the stain is gone. Allow cushions to air dry.
- **FABRIC CARE:** Hand wash with cold water, non-chlorine bleach when needed, and lay flat to dry. Cool iron if necessary. Do not dry clean.
- **RESIN WICKER PRODUCT CARE:**
 1. General Cleaning: Before use, clean the product with a soft, dry towel. When not in use, wipe off any dirt or loose debris. For regular cleaning, use a mild soap and water solution, rinse thoroughly, and dry completely.
 2. Weather Protection: To prolong the life of your resin wicker, avoid prolonged exposure to intense sunlight or heavy rain. Whenever possible, use a protective cover when the furniture is not in use, especially during extreme weather conditions.
 3. Avoid Harsh Cleaners: Do not use strong detergents or abrasive cleaners, as these may damage the finish.
- Regular Maintenance:** Over time, nuts and bolts may loosen. Occasionally check and re-tighten them on all products as needed.



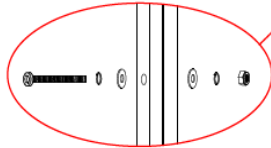
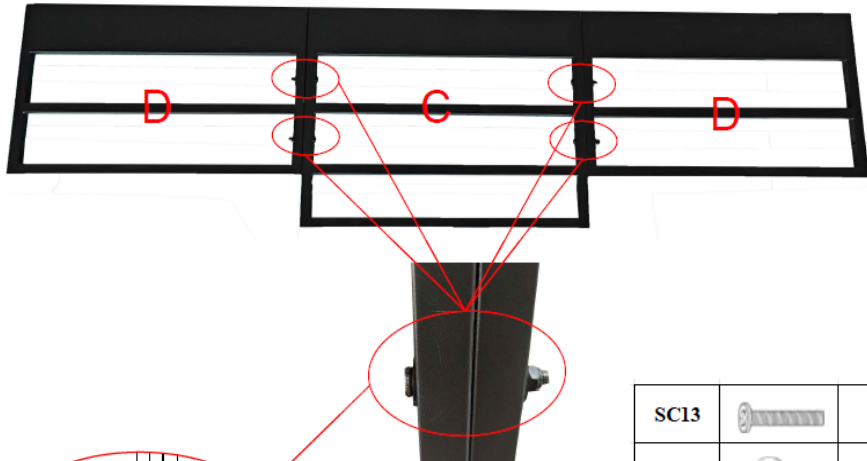

Assembly Instructions for 1PC Three Seat Sofa

A	B	C	D
			
<small>1PC Left Sofa Arm</small>	<small>1PC Right Sofa Arm</small>	<small>1PC Middle Sofa Back</small>	<small>2PCS Side Sofa Back</small>
E	F	G	H
			
<small>1PC Middle Seat Panel</small>	<small>2PCS Side Seat Panel</small>	<small>1PC Middle Back Panel</small>	<small>4PCS Side Panel</small>
I	J	K	L
			
<small>1PC Middle Front Panel</small>	<small>2PCS Middle Leg</small>	<small>3PCS Seat Cushion</small>	<small>3PCS Back Cushion</small>
SC3	SC6	SC8	SC9
			
M6*15mm <small>4PCS Bolt</small>	M6*30mm <small>8PCS Bolt</small>	M6*35mm <small>8PCS Bolt</small>	M6*40mm <small>16PCS Bolt</small>
SC13	SC1	SC17	SC33
			
M6*55mm <small>10PCS Bolt</small>	<small>1PC Allen Wrench</small>	Ø16*Ø6.5*1mm <small>52PCS Washer</small>	Ø18*Ø6.5*1mm <small>12PCS Washer</small>
SC19	SC20	Tools:	
		<div style="display: flex; justify-content: space-between; align-items: center;"> <div style="border: 1px dashed black; padding: 5px;"> <p style="text-align: center; margin: 0;">SC30 :Socket Wrench</p>  </div> <div style="text-align: center;"> <p>SC29 Ratchet Wrench</p>  <p style="font-size: small;">Tightening ← → Loosing</p> </div> </div>	
M6 <small>26PCS Spring Washer</small>	M6 <small>18PCS M6 Nuts</small>		

1. Secure the Middle Sofa Back (C) to assembled Side Sofa Back (D) with 4 bolts (SC13), 8 Washers (SC33), 8 Spring Washers (SC19) and 4 M6 Nuts (SC20), using an Allen Wrench (SC1) and a Socket wrench (SC30). **Ensure all bolts are properly tightened.**





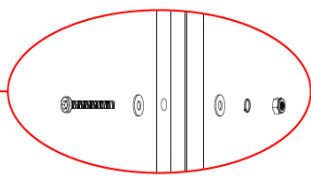
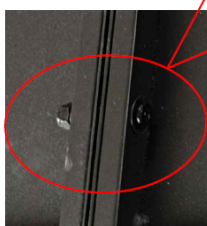
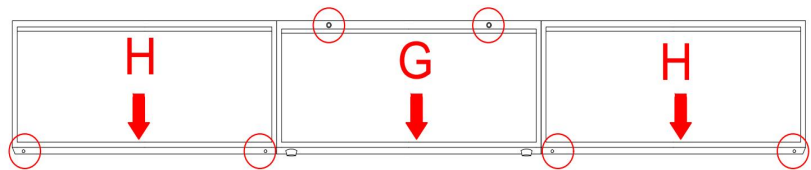

SC13 SC19 SC33 SC33 SC19 SC20

SC13		M6*55mm	4
SC33		Ø18*Ø6.5*1mm	8
SC19		Spring Washer	4
SC20		M6 Nut	4





2. Secure the Middle Back Panel (G) to assembled Side Panel (H) with 4 bolts (SC8), 8 Washers (SC17), 4 Spring Washers (SC19) and 4 M6 Nuts (SC20), using an Allen Wrench (SC1) and a Socket wrench (SC30). **Ensure all bolts are properly tightened.**



SC8 SC17 SC17 SC19 SC20



SC8		M6*35mm	4
SC17		Ø16*Ø6.5*1mm	8
SC19		Spring Washer	4
SC20		M6 Nut	4

3. Secure the Middle Front Panel (I) to assembled Side Panel (H) with 4 Bolts (SC8), 8 Washers (SC17), 4 Spring Washer (SC19) and 4 M6 Nuts (SC20), using an Allen Wrench (SC1) and a Socket wrench (SC30). **Ensure all bolts are properly tightened.**

SC8		M6*35mm	4
SC17		Ø16*Ø6.5*1mm	8
SC19		Spring Washer	4
SC20		M6 Nut	4

SC20 SC19 SC17 SC17 SC8

4. Secure the Middle Sofa Back (C) to assembled Middle Back Panel (I) with 2 Bolts (SC9), 2 Washers (SC17), using an Allen Wrench (SC1). **Ensure all bolts are properly tightened.**

SC9		M6*40mm	2
SC17		Ø16*Ø6.5*1mm	2

SC17
SC9

5. Secure the Left Arm (A) to assembled Left Back (D) with 2 Bolts (SC9), 2 Spring Washer (SC19) and 2 Washers (SC33) ; Secure the Left Arm (A) to assembled Left Back (H) with 2 Bolts (SC6), 2 Washers (SC17), using an Allen Wrench (SC1). **Ensure all bolts are loose to allow for alignment.**

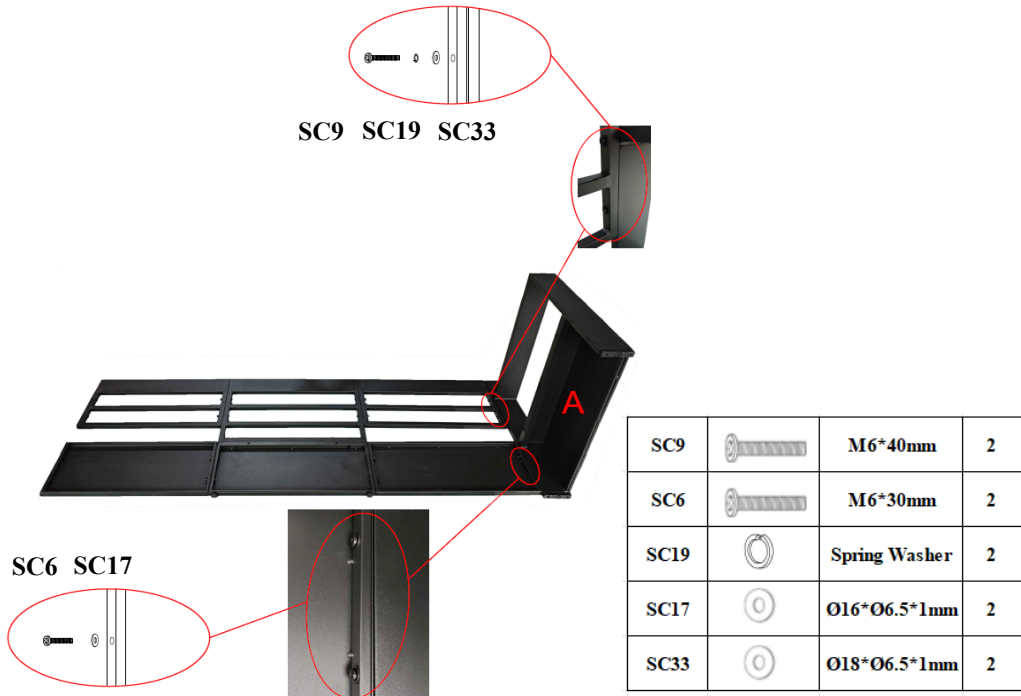

6. Secure the Right Arm (B) to assembled Right Back (D) with 2 Bolts (SC9), 2 Spring Washer (SC19) and 2 Washers (SC33) ; Secure the Right Arm (B) to assembled Right Back (H) with 2 Bolts (SC6), 2 Washers (SC17), using an Allen Wrench (SC1). **Ensure all bolts are loose to allow for alignment.**

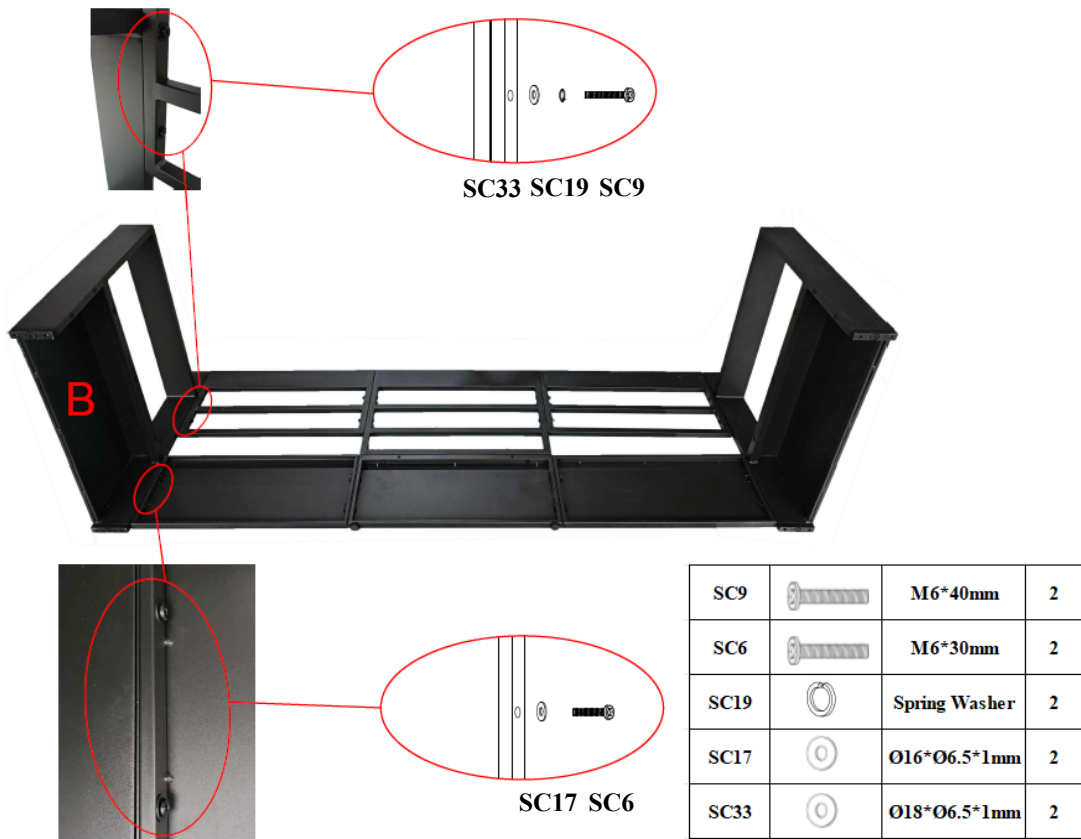

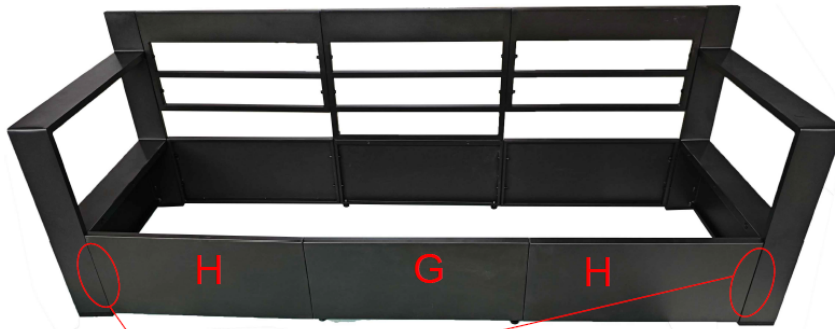

7. Secure the Front Panel (H & G) to assembled Sofa Arm (A & B) with 4 Bolts (SC6), 4 Washers (SC17), using an Allen Wrench. **Ensure all bolts are loose to allow for alignment.**

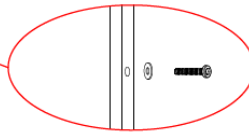

SC17 SC6



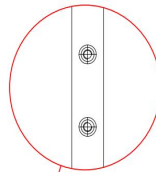
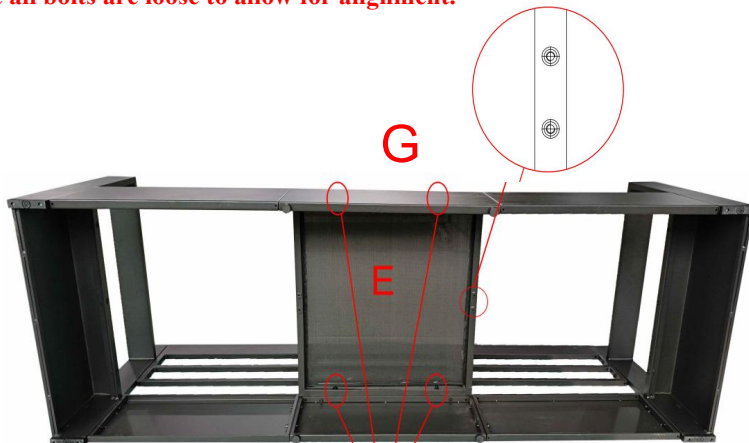

SC6		M6*30mm	4
SC17		Ø16*Ø6.5*1mm	4

8. Secure the Middle Seat Panel (E) to assembled Middle Front Panel (I) and Middle Back Panel (G) with 4 Bolts (SC9), 4 Washers (SC17), using an Allen Wrench (SC1). **Ensure all bolts are loose to allow for alignment.**



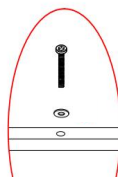





SC9
SC17

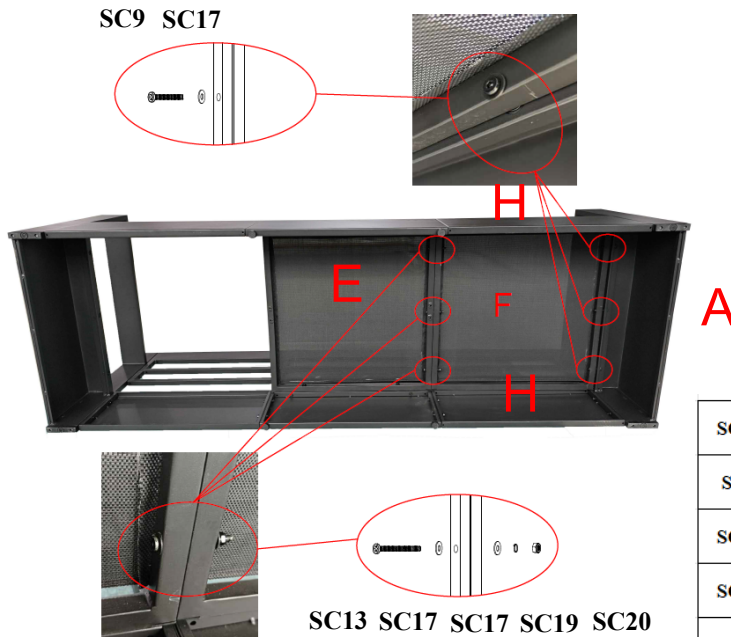

SC9		M6*40mm	4
SC17		Ø16*Ø6.5*1mm	4

9. Secure the Side Panel (F) to assembled Left Arm (A) with 3 Bolts (SC9) and 3 Washers (SC17). Secure the Middle Panel (E) to assembled Side Panel (F) with 3 Bolts (SC13), 6 Washers (SC17), 3 Spring Washers (SC19) and 3 M6 Nuts (SC20), using an Allen Wrench (SC1) and a Socket Wrench (SC30). **Ensure all bolts are loose to allow for alignment.**





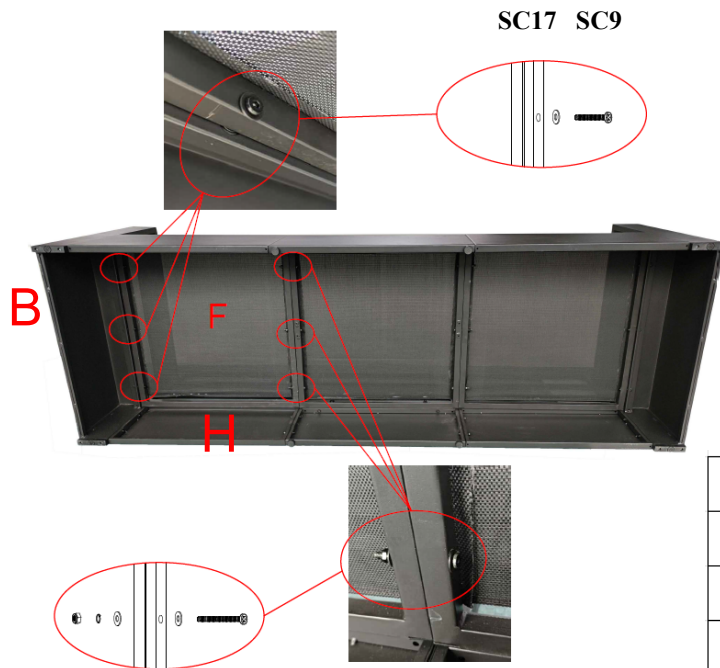

SC13		M6*55mm	3
SC9		M6*40mm	3
SC17		Ø16*Ø6.5*1mm	9
SC19		Spring Washer	3
SC20		M6 Nut	3

10. Secure the Side Panel (F) to assembled Right Arm (B) with 3 Bolts (SC9), 3 Washers (SC17). Secure the Middle Panel (E) to assembled Side Panel (F) with 3 Bolts (SC13), 6 Washers (SC17), 3 Spring Washers (SC19) and 3 M6 Nuts (SC20), using an Allen Wrench (SC1) and a Socket Wrench (SC30). **Ensure all bolts are loose to allow for alignment.**





SC20 SC19 SC17 SC17 SC13

SC13		M6*55mm	3
SC9		M6*40mm	3
SC17		Ø16*Ø6.5*1mm	9
SC19		Spring Washer	3
SC20		M6 Nut	3

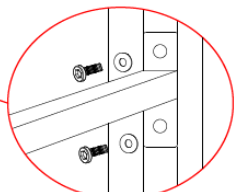
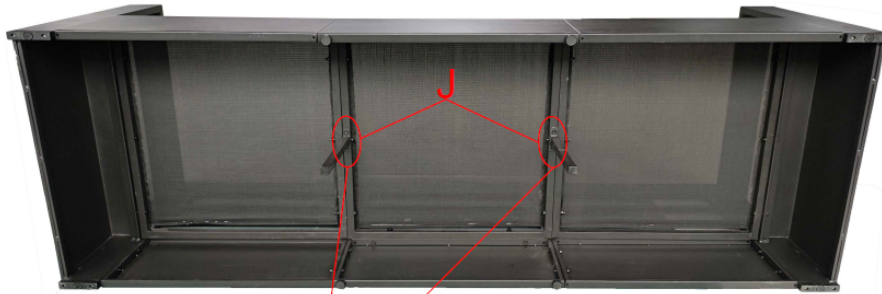
11. Secure the Middle Legs (J) to assembled Middle Seat Panel (E) with 4 Bolts (SC3) & 4 Washer (SC17), using an Allen Wrench (SC1). **Ensure all bolts are properly tightened.**



SC3 SC17

SC3		M6*15mm	4
SC17		Ø16*Ø6.5*1mm	4

12. Place the Seat and Back Cushions (L & K) onto the Sofa and it is ready for use.

Tips: All Seat Cushions should be tightened on the Back Panel, Right image for reference.

