

ASSEMBLY INSTRUCTIONS

MODEL#:7113 WHITE KITCHEN ISLAND (V#12600LBFC)







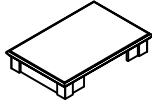
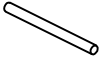

MODEL#: 7114 BLACK KITCHEN ISLAND (V#12600LBFC)

NOTE:THIS ITEM NOT RECOMMENDED FOR COMMERCIAL
USE KEEP THIS DOCUMENT FOR REFERENCE IN CASE PARTS ARE NEEDED
DO NOT TIGHTEN SCREWS UNTIL COMPLETELY ASSEMBLED!!

Thank you for your purchase of Bernard's Payson Kitchen Cart. Please keep in mind the purpose of this item is decorative and the top is not intended for the following, but not limited to: Cutting directly on the surface, Hot or cold items placed directly on, Acidic items including Vinegar or Lemon Juice on the surface.

Care Instructions:

Please wipe clean using a non-abrasive mild soap and warm water.











NO	PARTS LIST		Q'TY
A		TOP	1PC
B		CROSS BAR	1PC
C		BAR SUPPORT	2PCS
D		WOOD PLUG	2PCS
E		FRAME	1PC
F		MIDDLE SHELF	1PC
G		BOTTOM SHELF	1PC
H		LEG	4PCS
I		BUN FOOT	4PCS
J		CUTTING BOARD	1PC

ASSEMBLY INSTRUCTIONS

MODEL#:7113 WHITE KITCHEN ISLAND (V#12600LBFC)

MODEL#: 7114 BLACK KITCHEN ISLAND (V#12600LBFC)

NOTE:THIS ITEM NOT RECOMMENDED FOR COMMERCIAL
USE KEEP THIS DOCUMENT FOR REFERENCE IN CASE PARTS ARE NEEDED
DO NOT TIGHTEN SCREWS UNTIL COMPLETELY ASSEMBLED!!

NO	HARDWARE LIST			Q'TY
1		BOLT	Ø5/16"x1-1/2"	8PCS
2		LOCK WASHER	Ø5/16"x10Dx1mm	8PCS
3		FLAT WASHER	Ø5/16"x22Dx2mm	8PCS
4		ALLEN WRENCH	2-1/4"x4mm	1PC
5		BRACKET	15mmx15mm	4PCS
6		SCREW	3x12mm	8PCS
7		SCREW	4x30mm	5PCS
8		WOOD DOWELS	Ø8x30mm	2PCS
9		BOLT	Ø1/4"x1-1/2"	2PCS
10		Lock Washer	Ø1/4"x10Dx1mm	2PCS
11		Flat Washer	Ø1/4"x19Dx2mm	2PCS

STEP 2

STEP 1

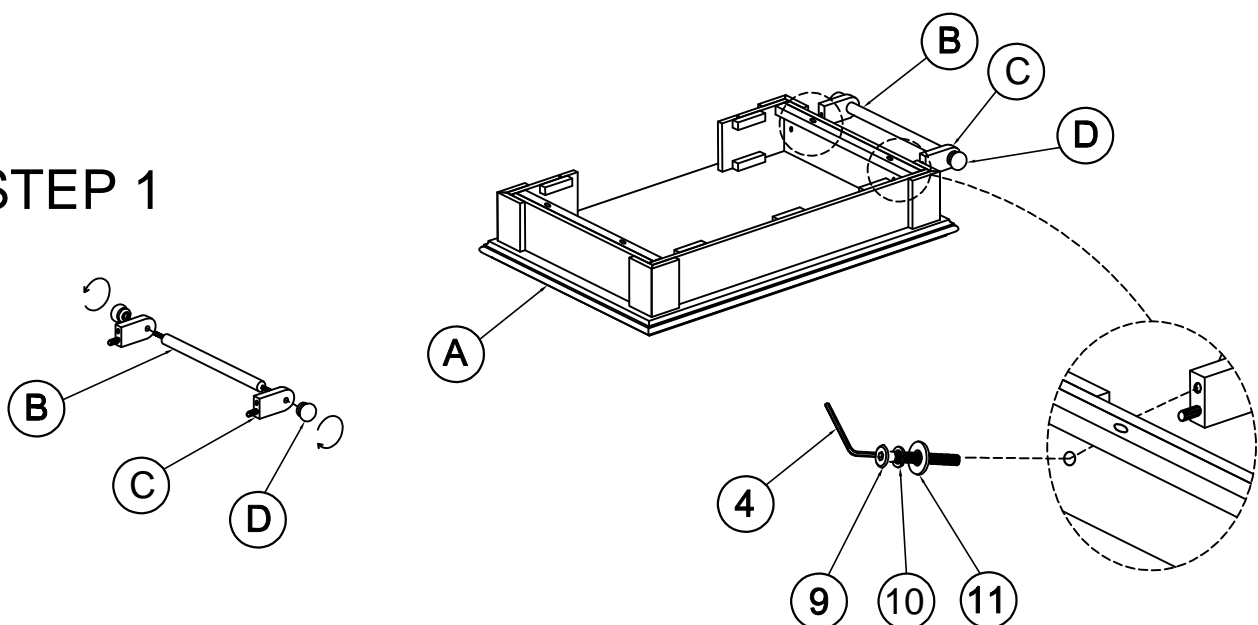

ASSEMBLY INSTRUCTIONS

MODEL#:7113 WHITE KITCHEN ISLAND (V#12600LBFC)

MODEL#: 7114 BLACK KITCHEN ISLAND (V#12600LBFC)

NOTE:THIS ITEM NOT RECOMMENDED FOR COMMERCIAL
USE KEEP THIS DOCUMENT FOR REFERENCE IN CASE PARTS ARE NEEDED
DO NOT TIGHTEN SCREWS UNTIL COMPLETELY ASSEMBLED!!

STEP 3

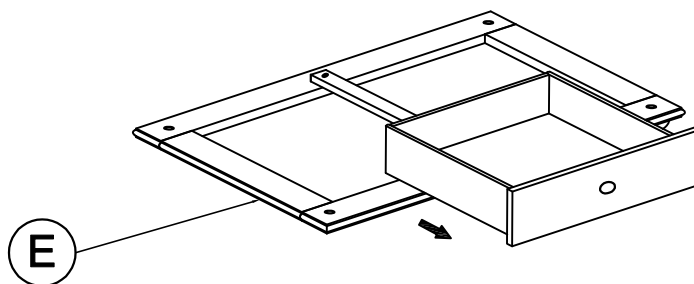

Pull out the drawer first

STEP 4

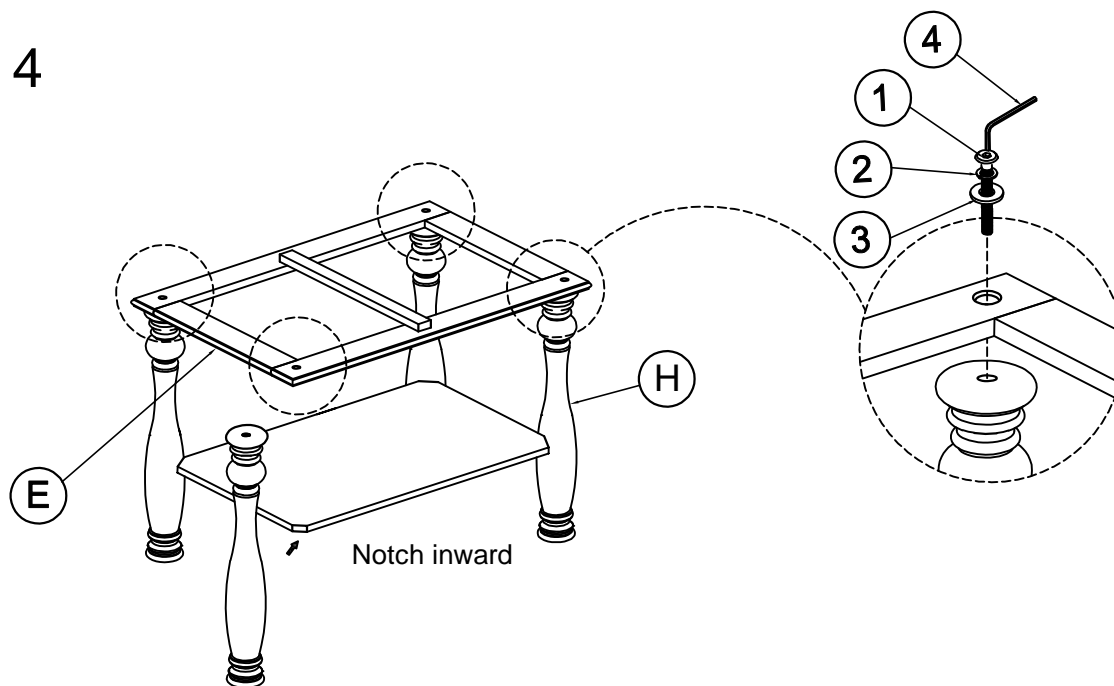

ASSEMBLY INSTRUCTIONS

MODEL#:7113 WHITE KITCHEN ISLAND (V#12600LBFC)

MODEL#: 7114 BLACK KITCHEN ISLAND (V#12600LBFC)

NOTE:THIS ITEM NOT RECOMMENDED FOR COMMERCIAL
USE KEEP THIS DOCUMENT FOR REFERENCE IN CASE PARTS ARE NEEDED
DO NOT TIGHTEN SCREWS UNTIL COMPLETELY ASSEMBLED!!

STEP 5

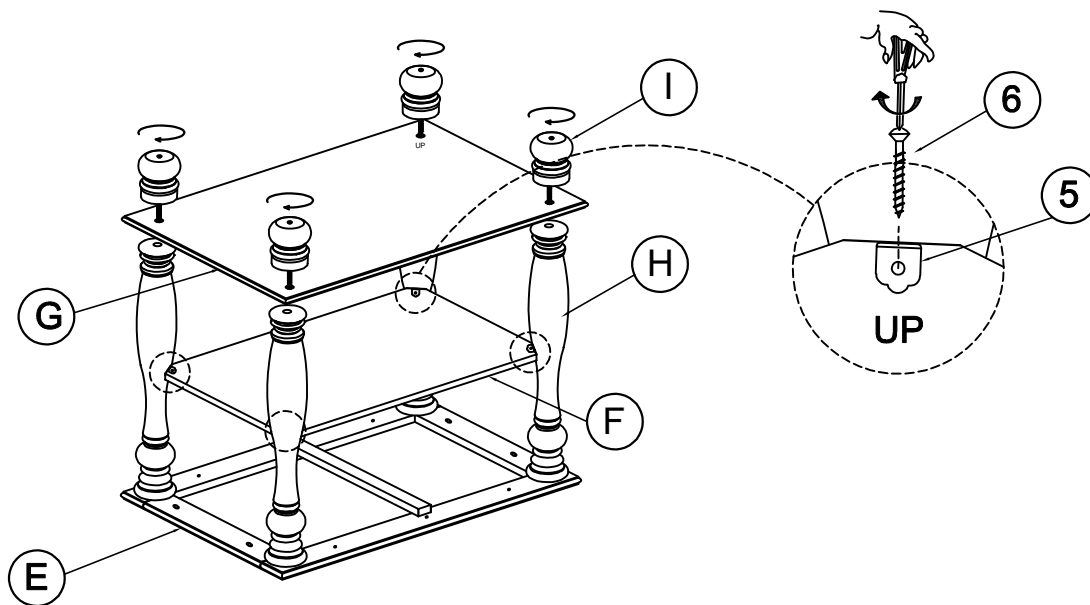

Tighten the bolt

STEP 6

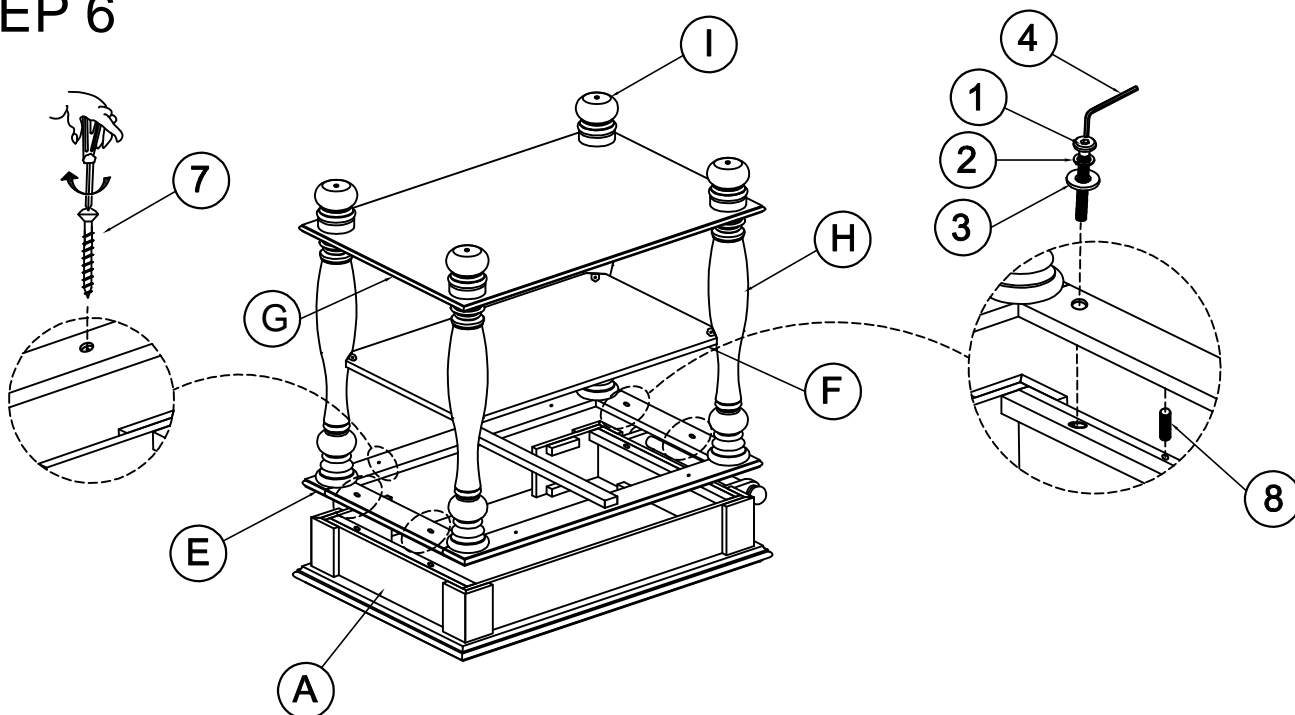

ASSEMBLY INSTRUCTIONS

MODEL#:7113 WHITE KITCHEN ISLAND (V#12600LBFC)

MODEL#: 7114 BLACK KITCHEN ISLAND (V#12600LBFC)

NOTE:THIS ITEM NOT RECOMMENDED FOR COMMERCIAL
USE KEEP THIS DOCUMENT FOR REFERENCE IN CASE PARTS ARE NEEDED
DO NOT TIGHTEN SCREWS UNTIL COMPLETELY ASSEMBLED!!

STEP 7

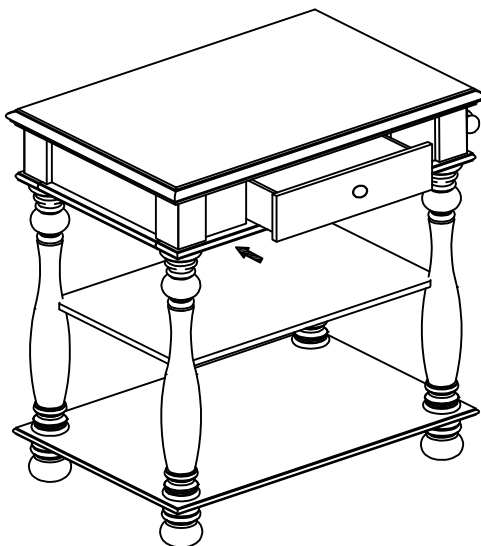

Insert the drawer after assembly
is complete

Assembly Completed