

CONVENIENCE CONCEPTS

NEWPORT CROSS CONSOLE TABLE

121679

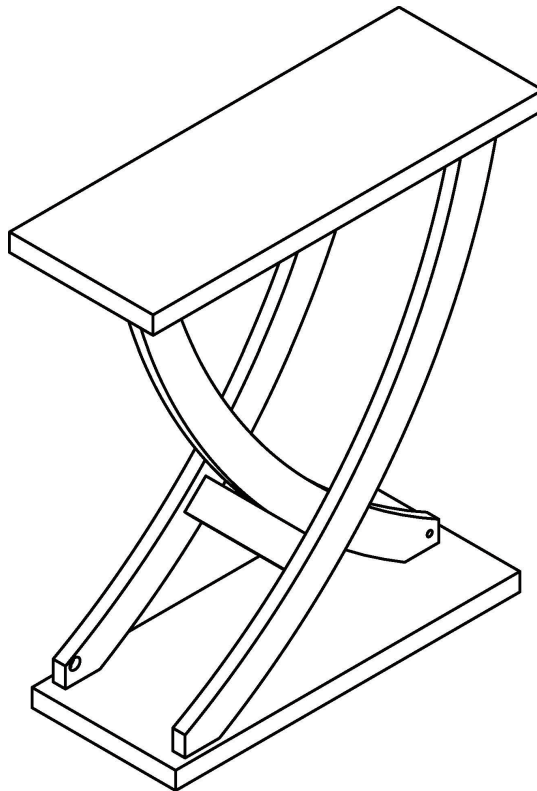

SCAN QR CODE FOR
E-MANUAL, IF DESIRED

Assembly instructions



















We have designed our furniture with you,space the customer in mind. Our clear,space easy to follow. Step by step instructions will guide you through the project from start to finish. Feel confident that this will be a fun and rewarding project .The final product will be a quality piece of furniture that will go together smoothly and give years of enjoyment.



Please do not return to the store
Broken or missing parts?
Need help with assembly?

Our Illinois based customer service team is ready to help with any problems or questions you may have. Please give us a call (Toll Free) at 1-800-468-6447, or email us at parts@convenience-concepts.com.
Normal hours of Operation: M-F* 8am-4pm CST.
*Excludes Holidays
This product's warranty is only valid through authorized dealers.

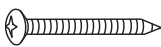
Hardware List

A  L40	B  Ø15×12	C  Ø8x30	D  M8
Cambolt (5 pcs)	Cam lock (5 pcs)	Dowel (6 pcs)	Jam washer&Nut (3 pcs)
E  M8x60	F  Ø13	G  Ø60	H  Ø20
Full threaded Rod (3 pcs)	Wrench (1 pc)	Large Sticker (3 pcs)	Medium Sticker (5 pcs)
I  Ø13	J  Ø15	K  Ø16×8x2	L  M6*65
Small Sticker (3 pcs)	Foot Pin (4 pcs)	Washer (6 pcs)	Barrel Bolt (3 pcs)
M  M6*13	N  M4	O  L250	P  25x13x9x1.0T
Barrel Nut (3 pcs)	Allen Wrench (1 pc)	ANTI-TIP Strap (1 pc)	Bracket (2 pcs)
Q  4x12	R  4x35	S  Ø6x30	T  (1 pc)
Small Screw (1 pc)	Wall Screw (1 pc)	Plastic Anchor (1 pc)	Glue (1 pc)
Glue: For securing please apply to wood dowel first before inserting into panel			

Please count and verify all parts before assembly.

Panel List

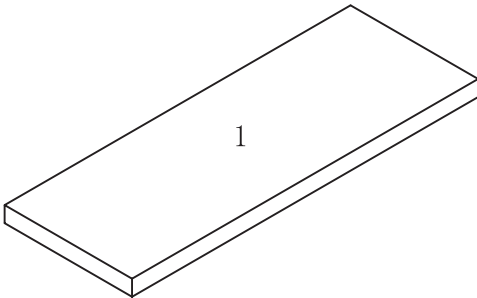

TOP(1pc)

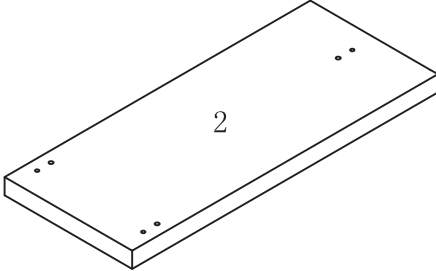

BOTTOM PANEL(1pc)

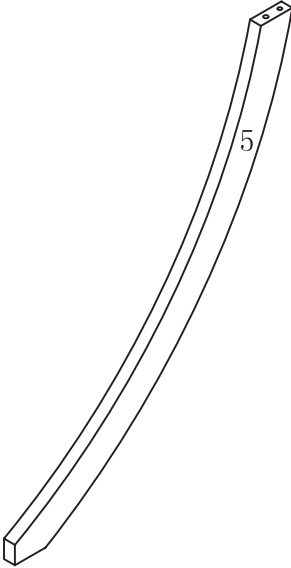

FRONT LEG(1pc)

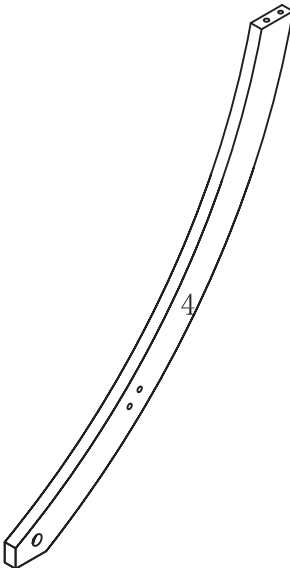

BACK LEG(1pc)

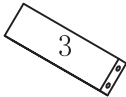

LEG CROSSBAR(1pc)

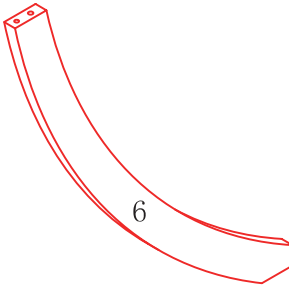

MIDDLE LEG(1pc)

Please count and verify all parts before assembly.

Assembling the unit with camlocks and wood dowels.

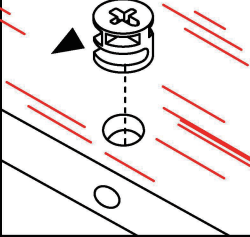
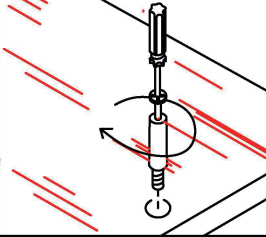
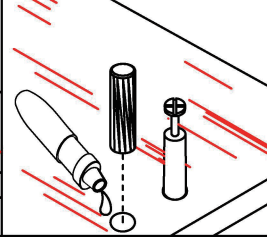
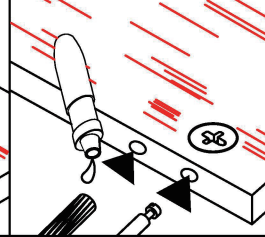
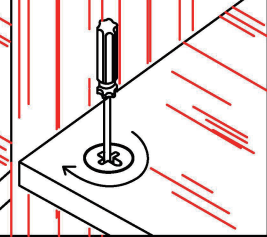
				
Insert camlock, camlock must face bolt hole	Gently screw cambolt into the threaded anchor	lightly glue one end of wood dowel and tap into hole.	lightly glue dowel and connect to second panel by inserting dowels into holes	Gently screw the cam clockwise into locked position. Do not overtighten.

Exploded Views

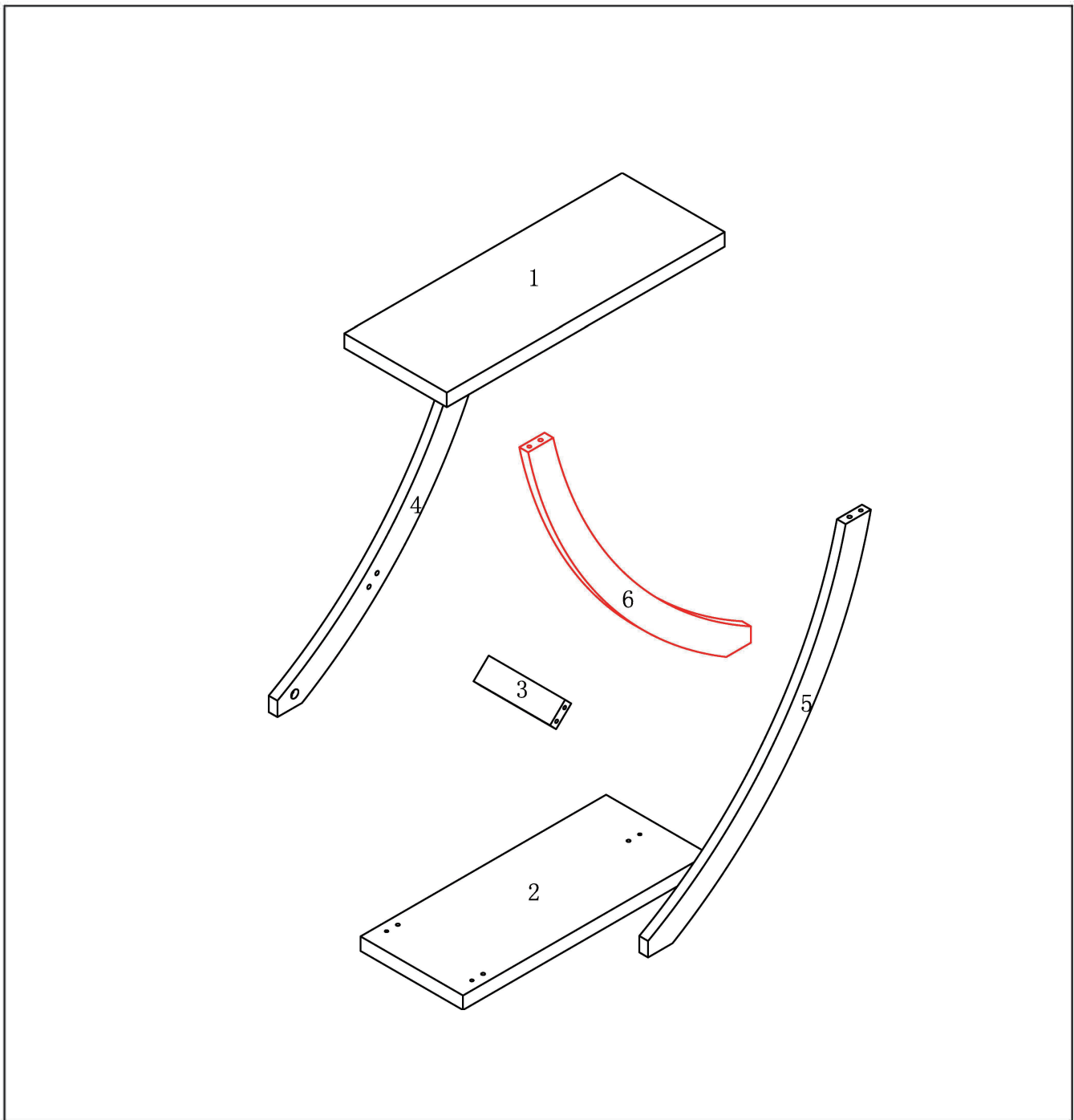

Step1

1. Screw cambolts(A) into middle leg(6).
2. Insert camlocks(B) into leg crossbar(3).
3. Connect middle leg(6) to leg crossbar(3) by gently tightening camlocks(B).
4. Cover camlocks(B) with medium stickers(H).

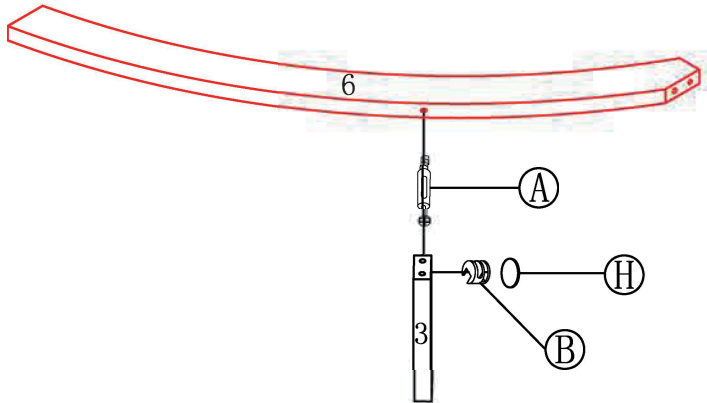

A		x1
B		x1
H		x1

Step2

1. Screw cambolts into back leg(4).
2. Insert camlocks(B) into leg crossbar(3).
3. Connect back leg(4) to leg crossbar(3) by gently tightening camlocks(B).
4. Cover camlocks(B) with medium stickers(H).

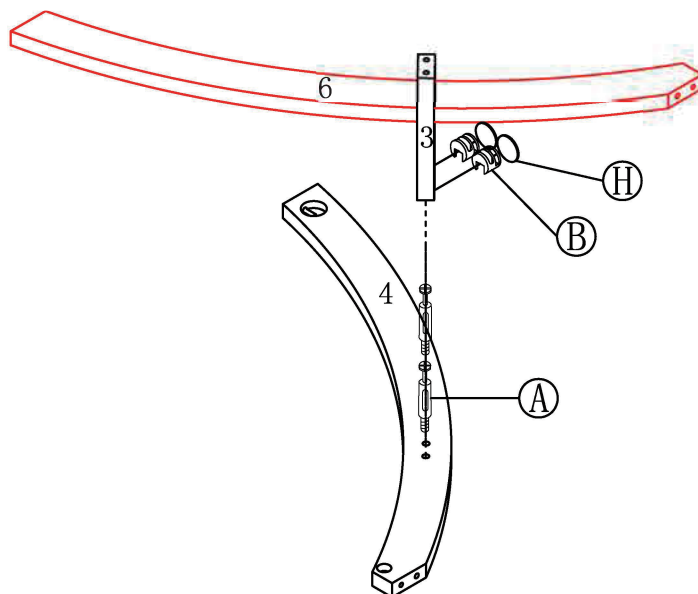

A		x2
B		x2
H		x2

Step3

1. Screw cambolts(A) into front leg(5).
2. Insert camlocks(B) into leg crossbar(3).
3. Connect front leg(5) to leg crossbar(3) by gently tighten camlocks.
4. Cover camlocks with medium stickers(H).

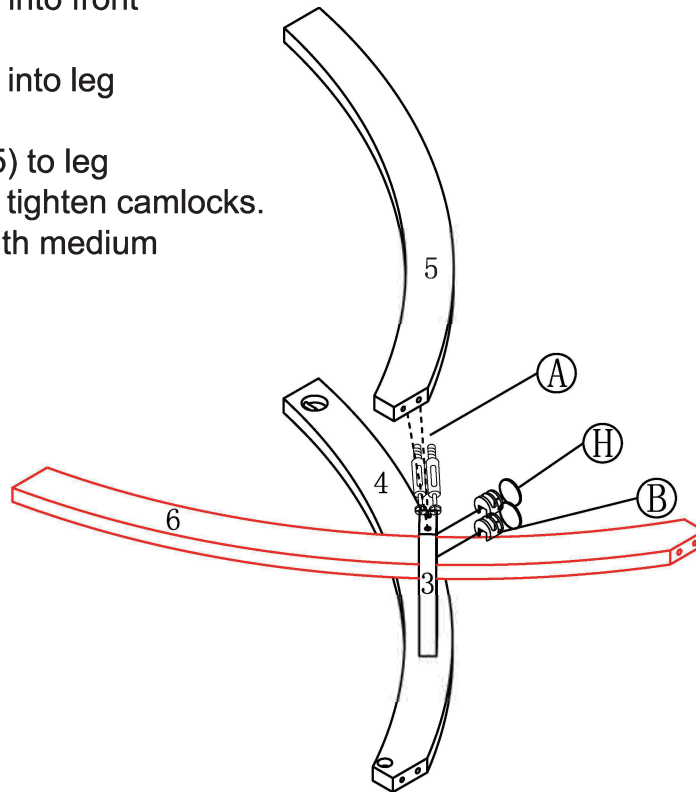

A		x2
B		x2
H		x2

Step4

1. Insert barrel nuts(M) and dowels(C) into legs(4),(5), and (6) as shown. Make sure thread on barrel nut faces bolt hole.
2. Attach bottom panel (2) to assembly using washer(K), barrel bolt(L), and allen wrench(N).
3. Cover barrel nuts with small stickers(I).

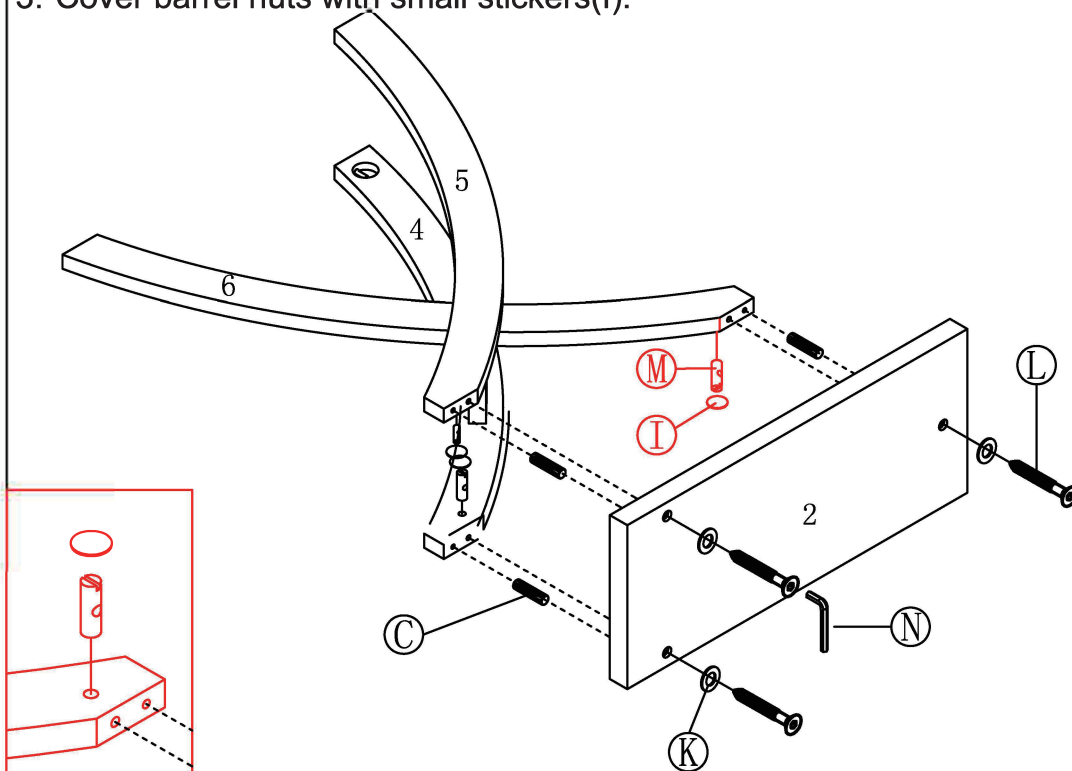

L		x3
K		x3
N		x1
C		x3
M		x3
I		x3

Step5

1. Gently tap foot pins(J) into bottom of bottom panel(2).

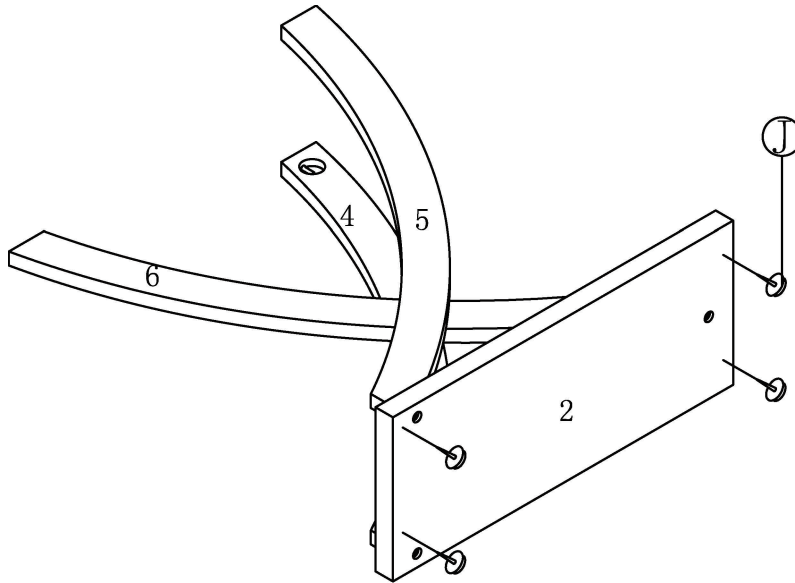
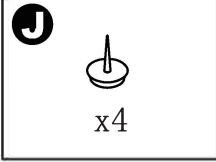

Step6

1. Screw fully threaded rods(E) into top panel(1).
2. Insert dowels(C) into legs(4),(5), and (6).
3. Connect top panel(1) to assembly using jam washer and nut(D), washer(K), and wrench(F) on full threaded rods(E) as shown.
4. Cover holes in legs(4),(5) and (6) with large stickers(G).

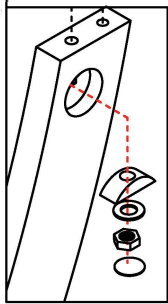
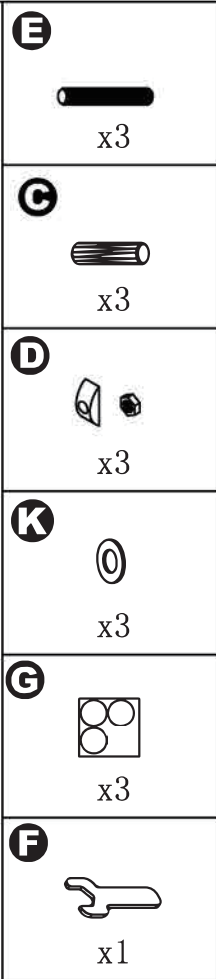
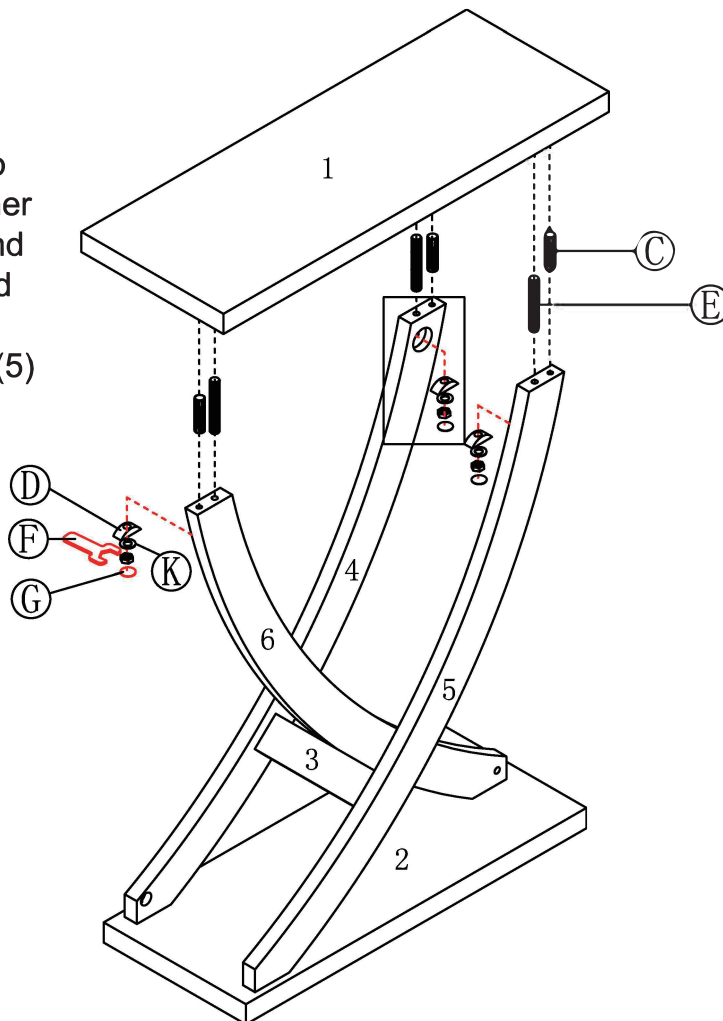

ANTI-TIPPING STRAP INSTRUCTION

HARDWARE (INCLUDED) :

S  DRYWALL ANCHOR $\phi 6 \times 30$ X 1PC

P  METAL BRACKETS $25 \times 13 \times 9 \times 1.0T$ X 2PCS

R  DRYWALL SCREW 4×35 X 1PC

O  STRAP $L250$ X 1PC

Q  FLATHEAD SCREW 4×12 X 1PC

TOOLS NEEDED (NOT INCLUDED) :

 DRILL & DRILL BIT

 LIGHT HAMMER

Note: Hardware included only compatible with standard drywalls.

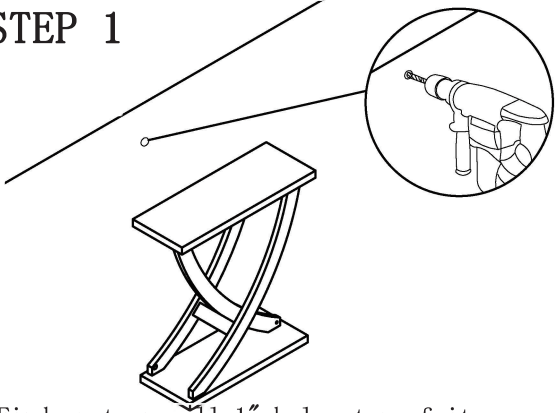
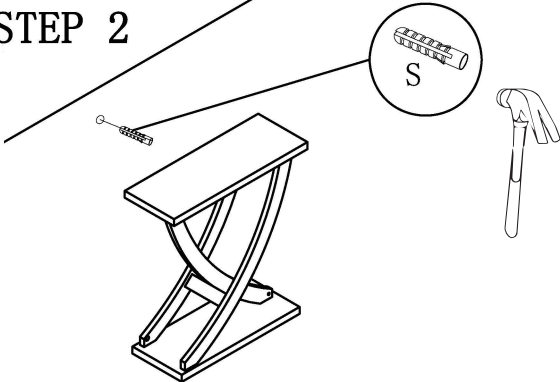
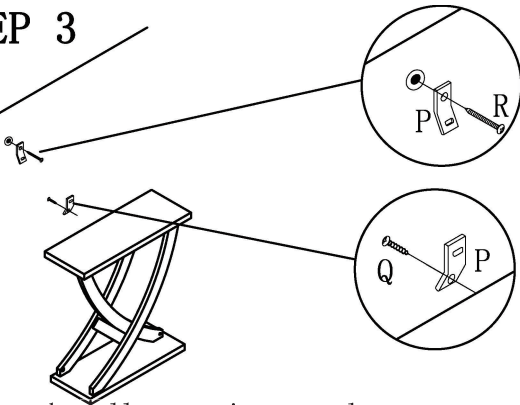
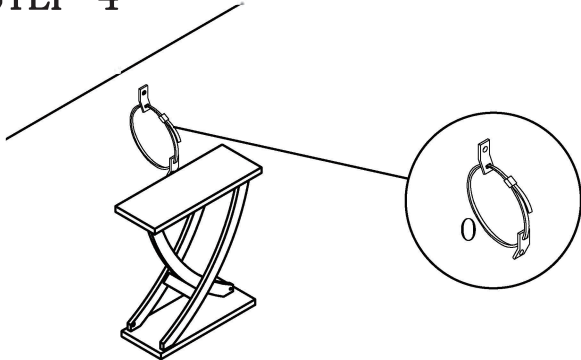
<p>STEP 1</p>  <p>1. Find spot on wall 1" below top of item. 2. Using a drill bit slightly thinner than anchor, drill hole into drywall.</p>	<p>STEP 2</p>  <p>1. Use a light hammer to tap anchor into hole. 2. Anchor should fit snugly. If hole is too small, drill again to increase hole size. Do not force anchor into wall.</p>
<p>STEP 3</p>  <p>1. Insert drywall screw into metal bracket and into drywall anchor. 2. Insert flathead screw into second metal bracket and into back of item along top edge.</p>	<p>STEP 4</p>  <p>1. Insert strap through bracket attached to wall, then through bracket on item, and into head of strap. 2. pull lightly til strap stops. Assembly is complete.</p>