

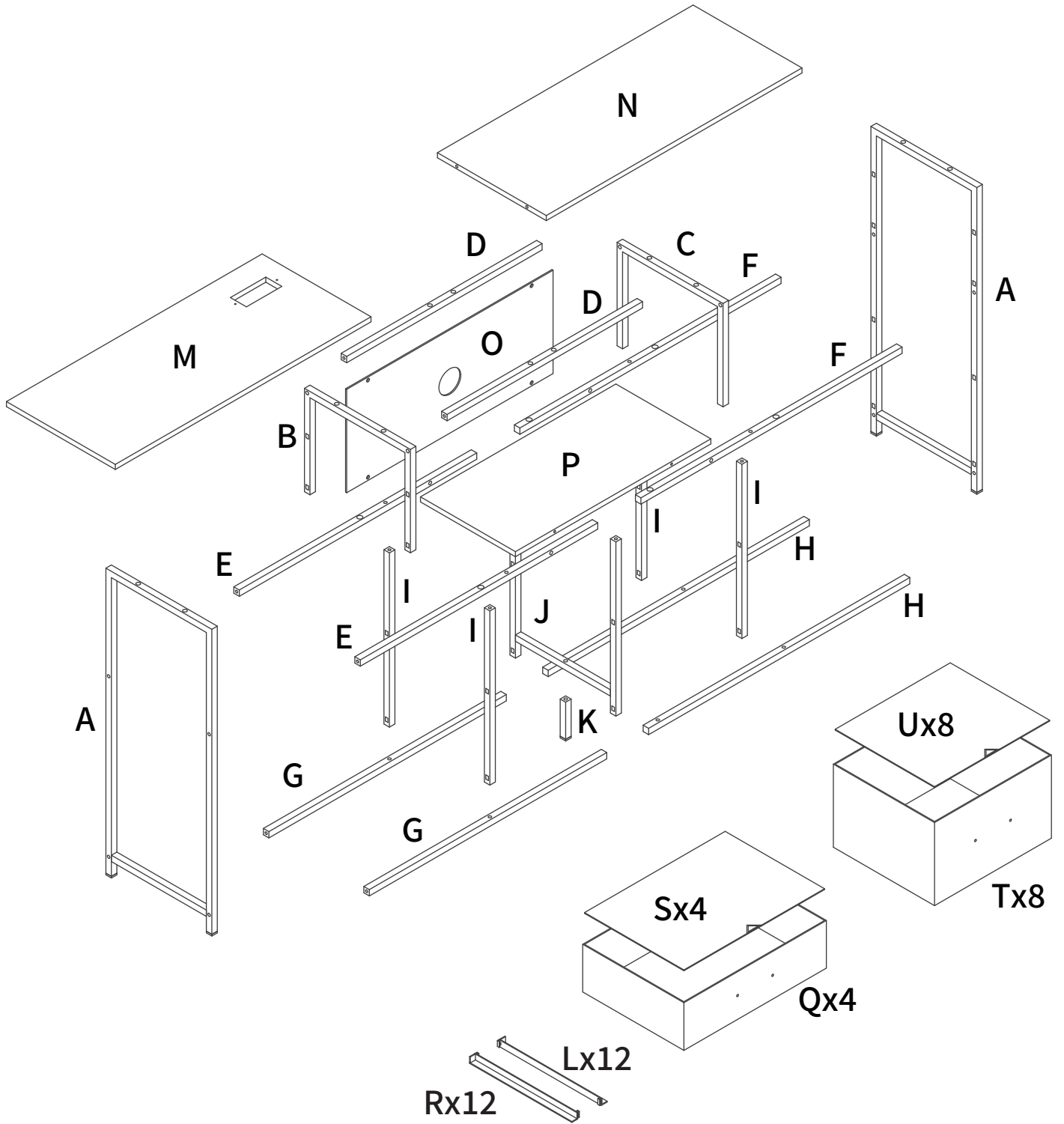



INSTALLATION ASSEMBLY



Disassembly Diagram

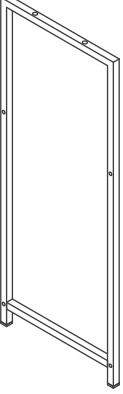
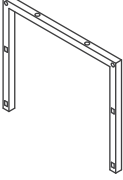
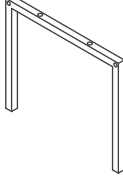
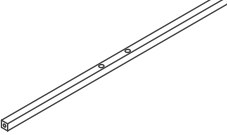
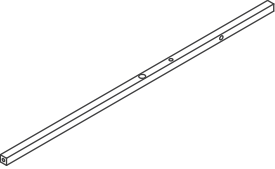
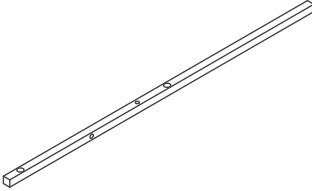
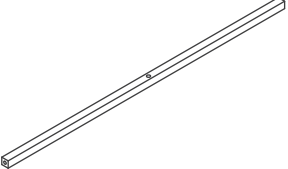
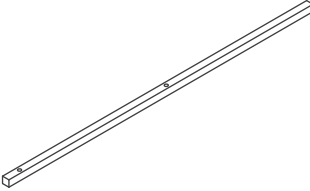

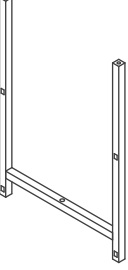

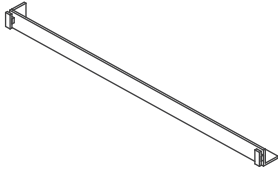
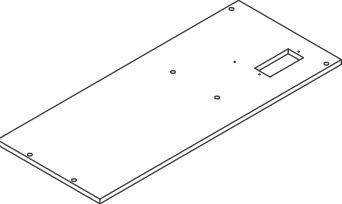
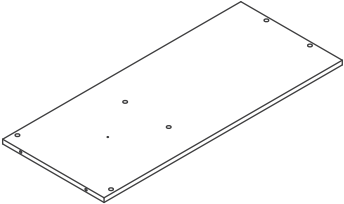
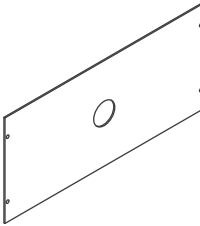
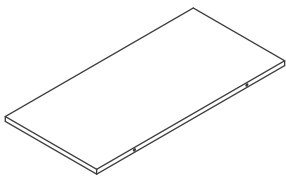

Accessories

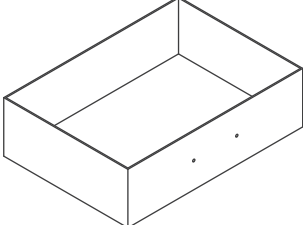
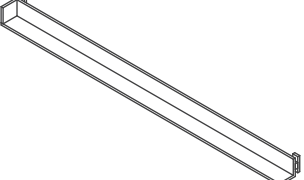
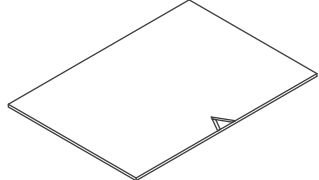
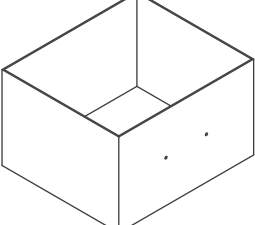
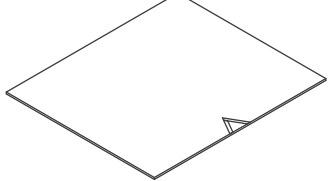
A x2 	B x1 	C x1 	D x2 
E x2 	F x2 	G x2 	H x2 
I x4 	J x1 	K x1 	L x13  1 Spare
M x1 	N x1 	O x1 	P x1 

Accessories

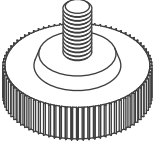
<p>Q x4</p> 	<p>R x13</p>  <p>1 Spare</p>	<p>S x4</p> 	<p>T x8</p> 
<p>U x8</p> 			

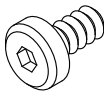
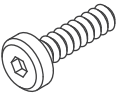
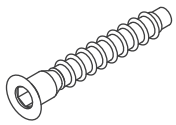
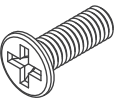
Accessories

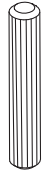
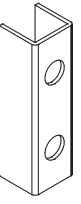
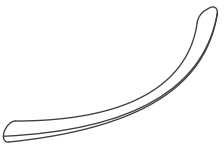
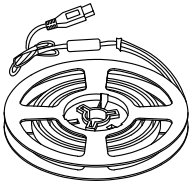
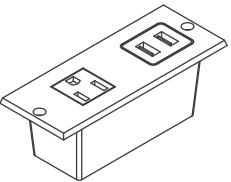
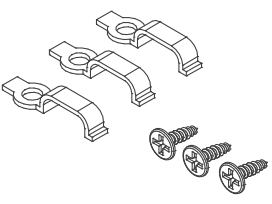
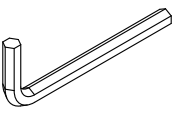
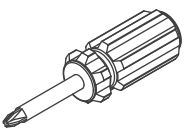
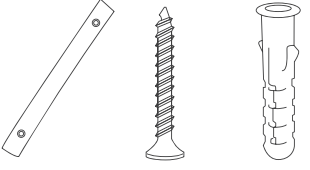
<p>① x6</p>  <p>M6 1 Spare</p>	<p>② x9</p>  <p>M5x9 1 Spare</p>	<p>③ x5</p>  <p>M6x12 1 Spare</p>	<p>④ x44</p>  <p>M6x23 3 Spares</p>
<p>⑤ x5</p>  <p>M6.3x45 1 Spare</p>	<p>⑥ x26</p>  <p>M4x8 2 Spares</p>	<p>⑦ x3</p>  <p>ST4x12 1 Spare</p>	<p>⑧ x3</p>  <p>1 Spare</p>
<p>⑨ x4</p> 	<p>⑩ x12</p> 	<p>⑪ x1</p> 	<p>⑫ x1</p> 
<p>⑬ x1</p> 	<p>⑭ x2</p> 	<p>⑮ x1</p> 	<p>⑯ x2</p> 

Assembly Instructions

Step1

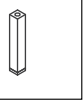
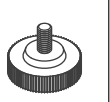
A x2	
K x1	
1 x5	

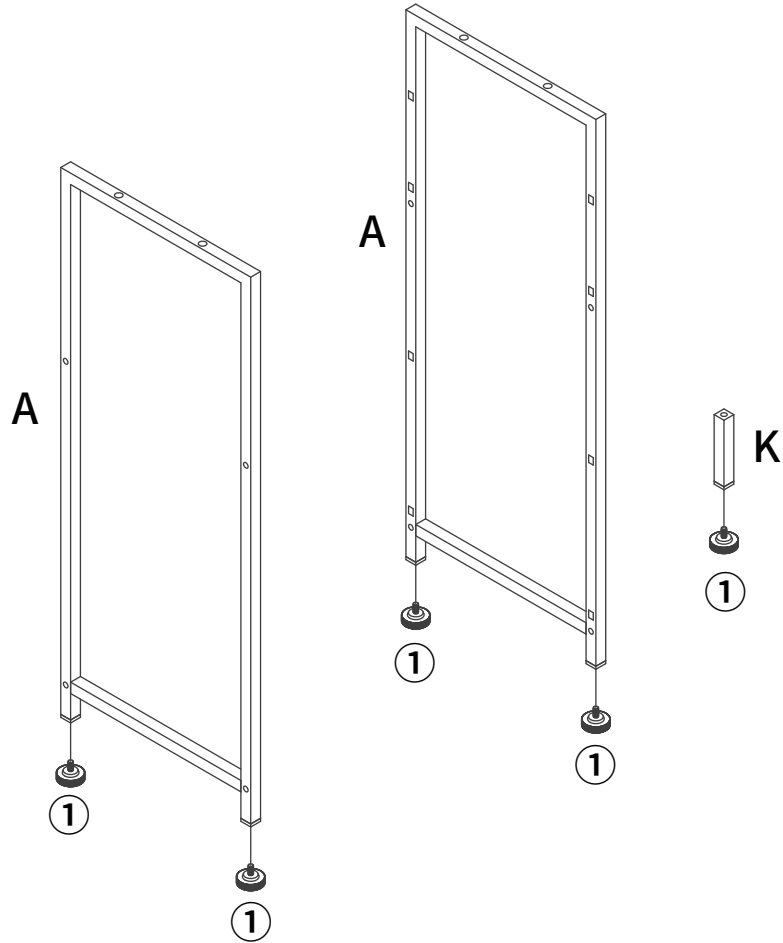

Step2

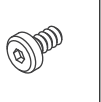
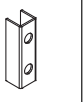
G x2	
2 x2	
9 x2	

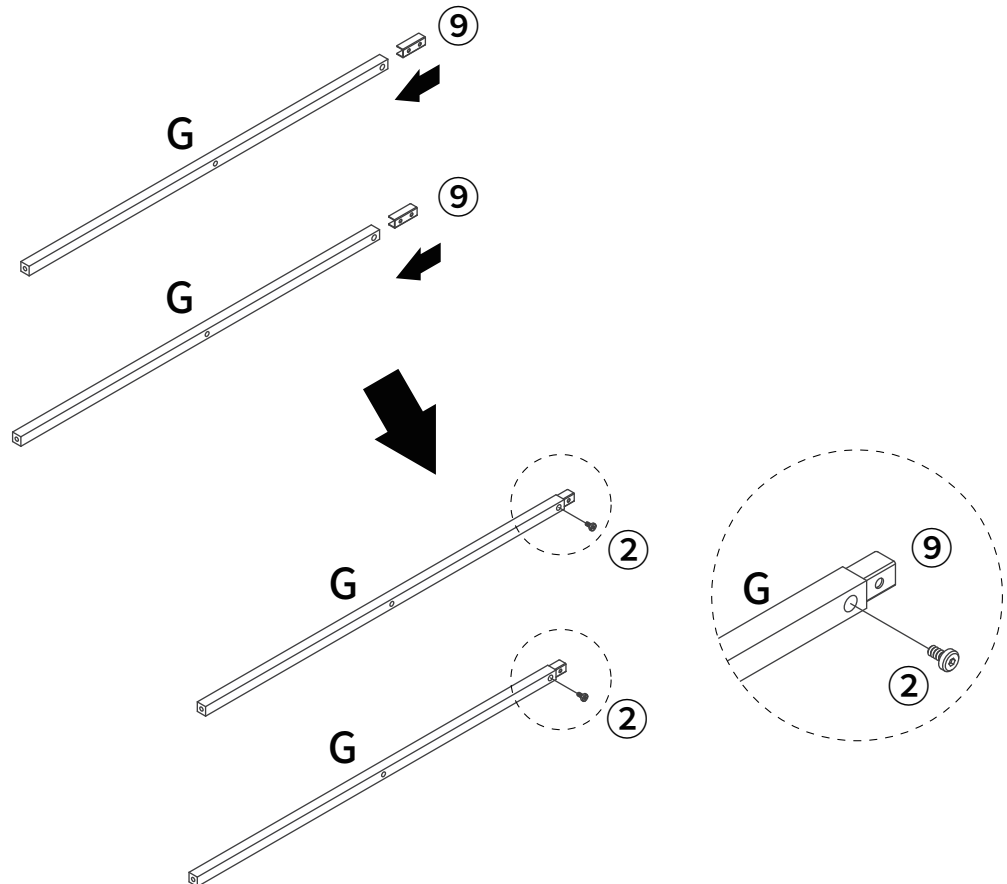

Assembly Instructions

Step3

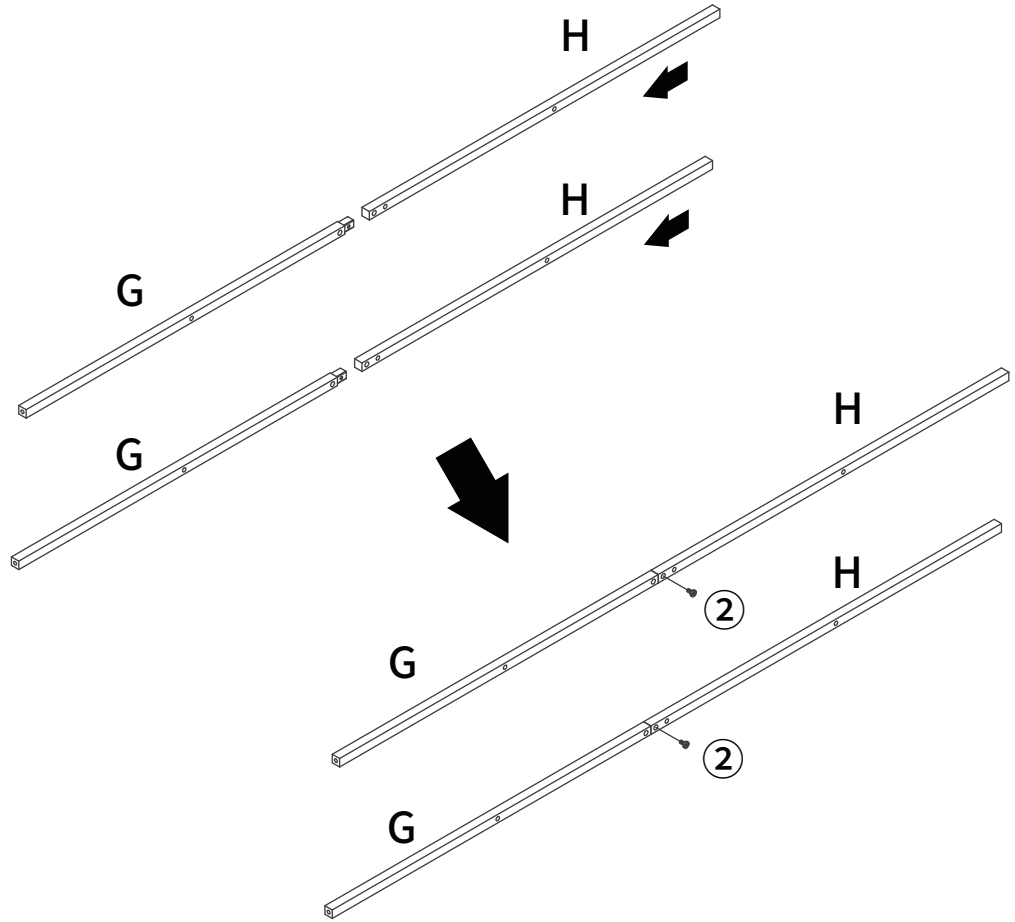
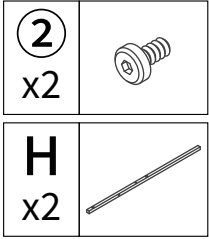

Step4

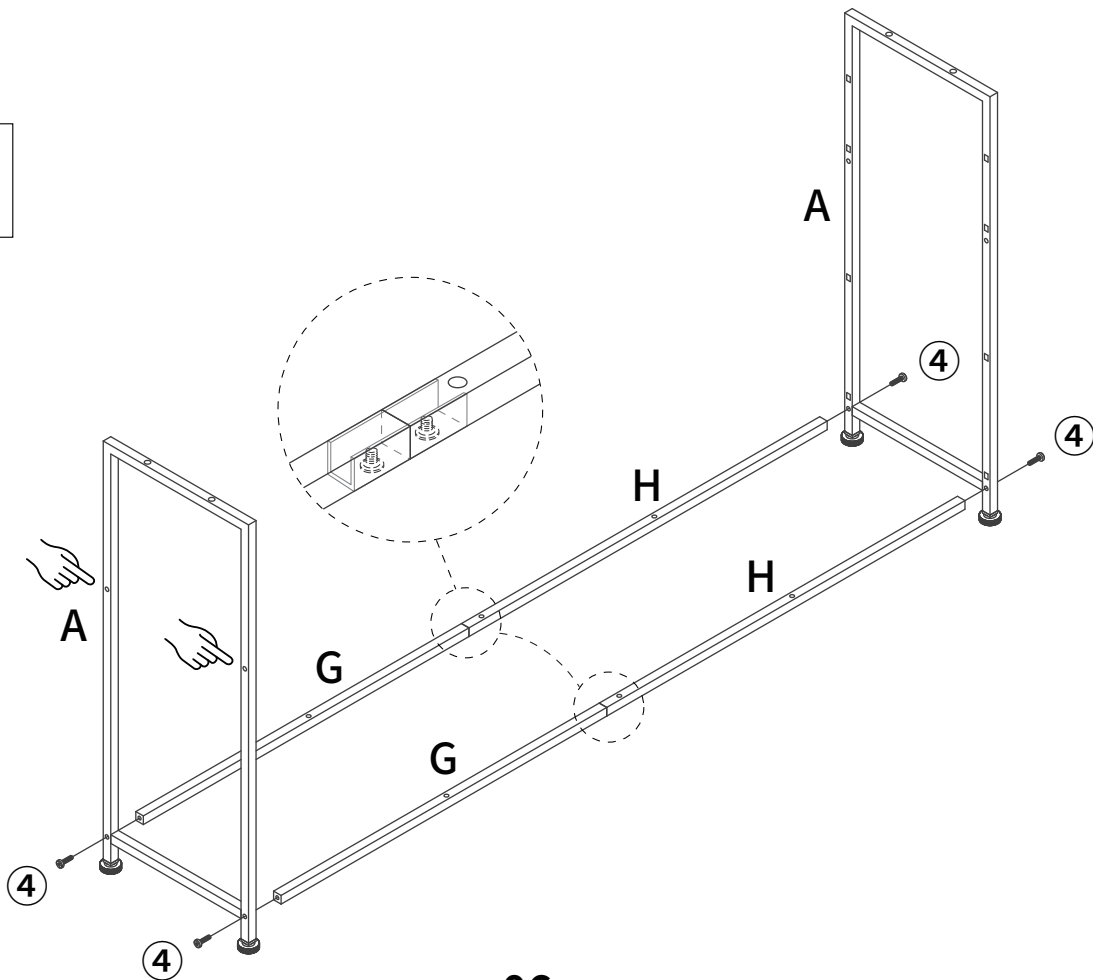
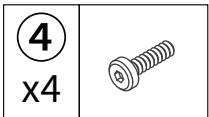

Assembly Instructions

Step5

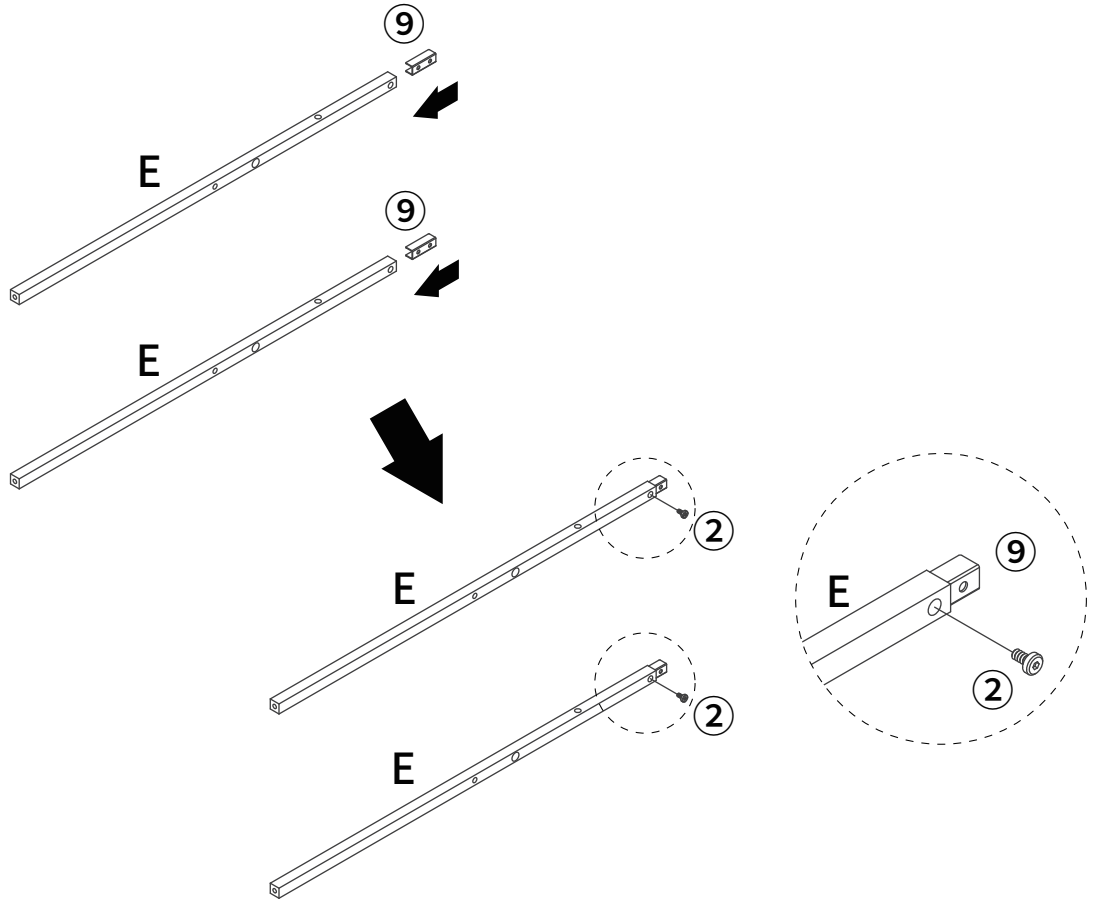
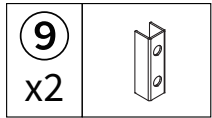
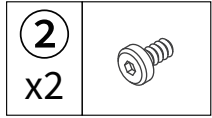
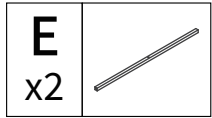

Step6

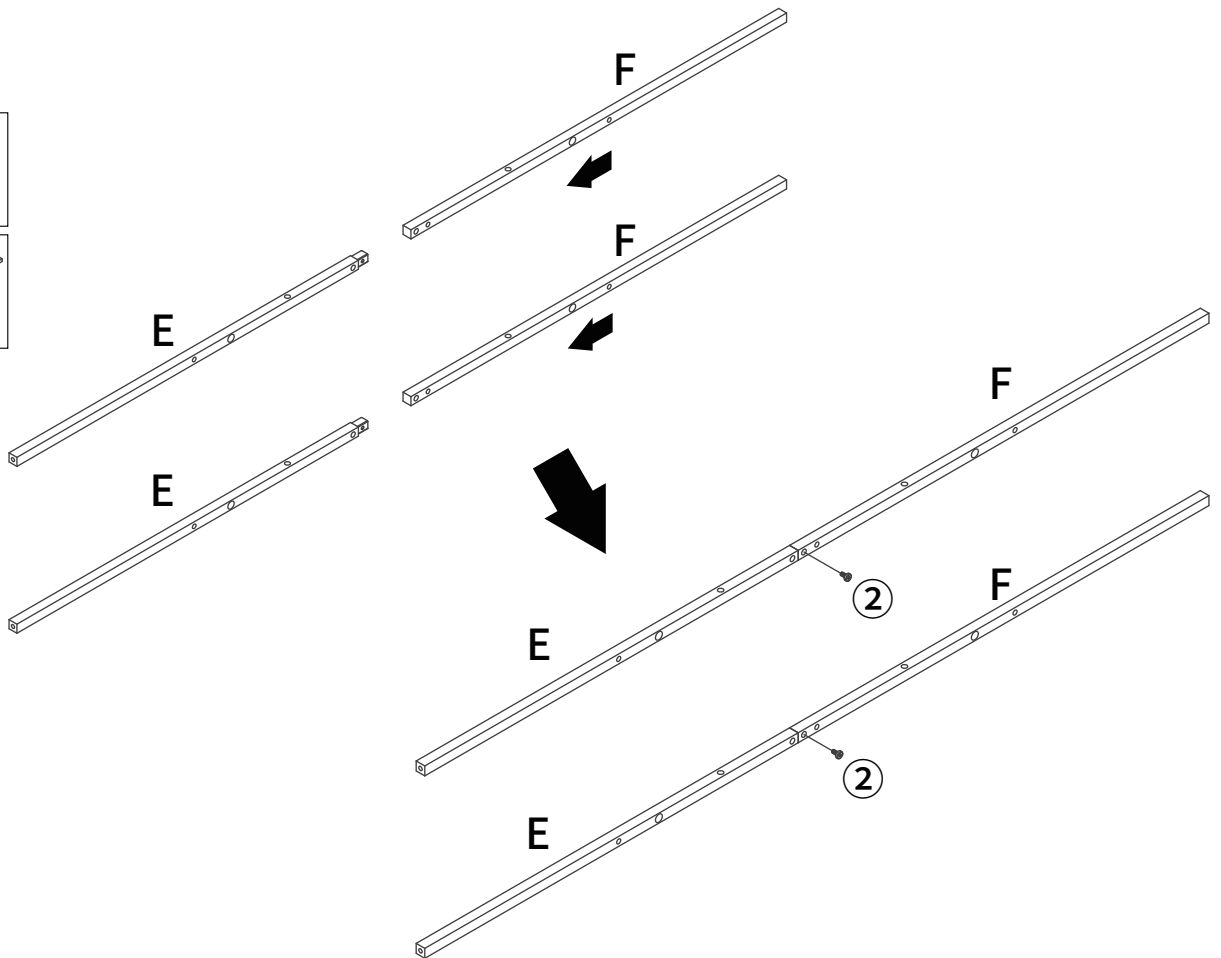
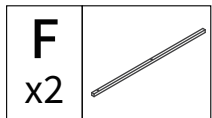
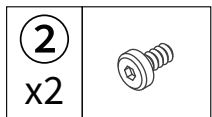

Assembly Instructions

Step7

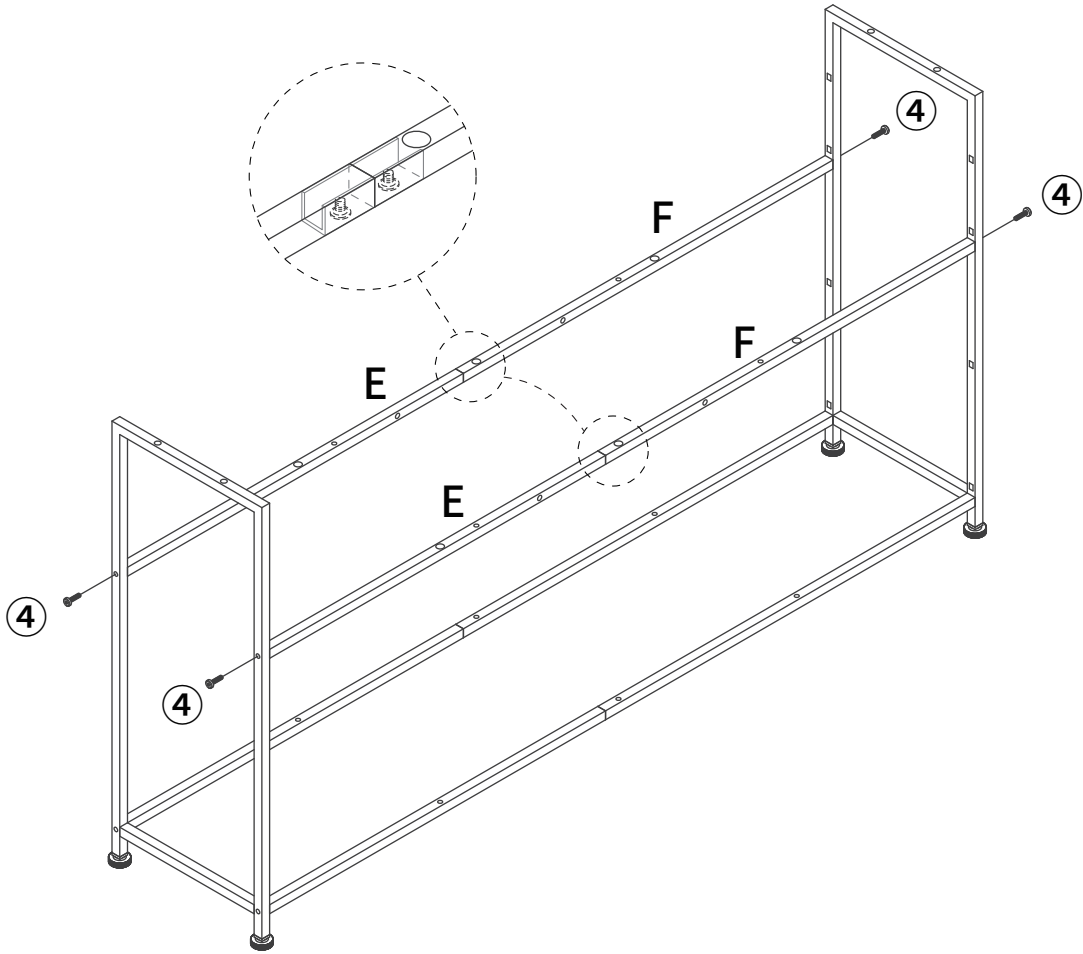
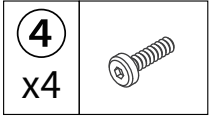

Step8

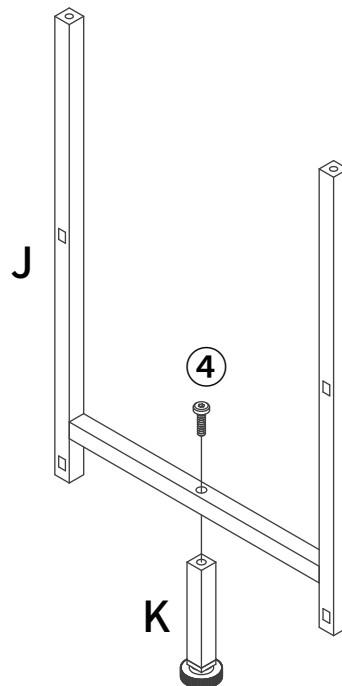
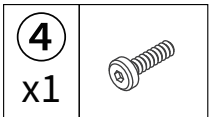
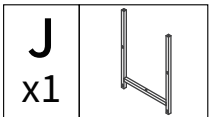

Assembly Instructions

Step9

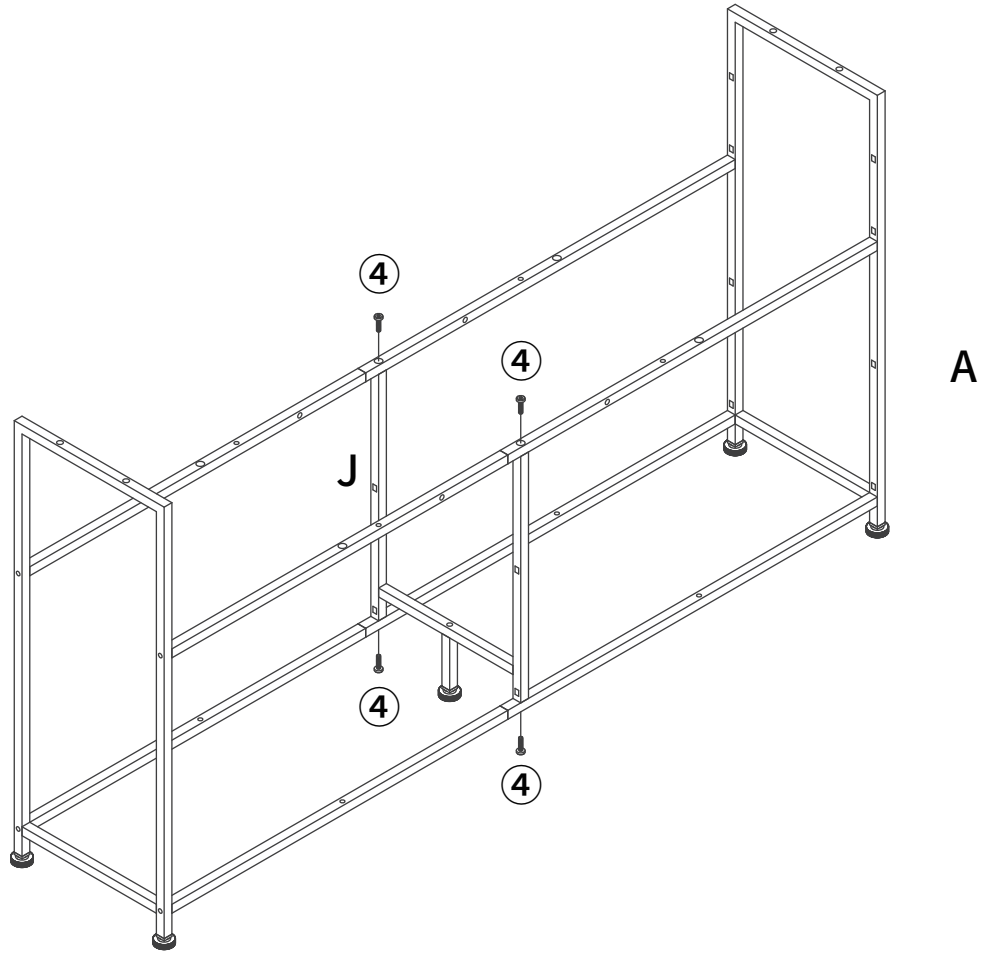
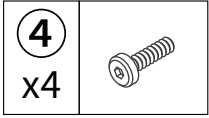

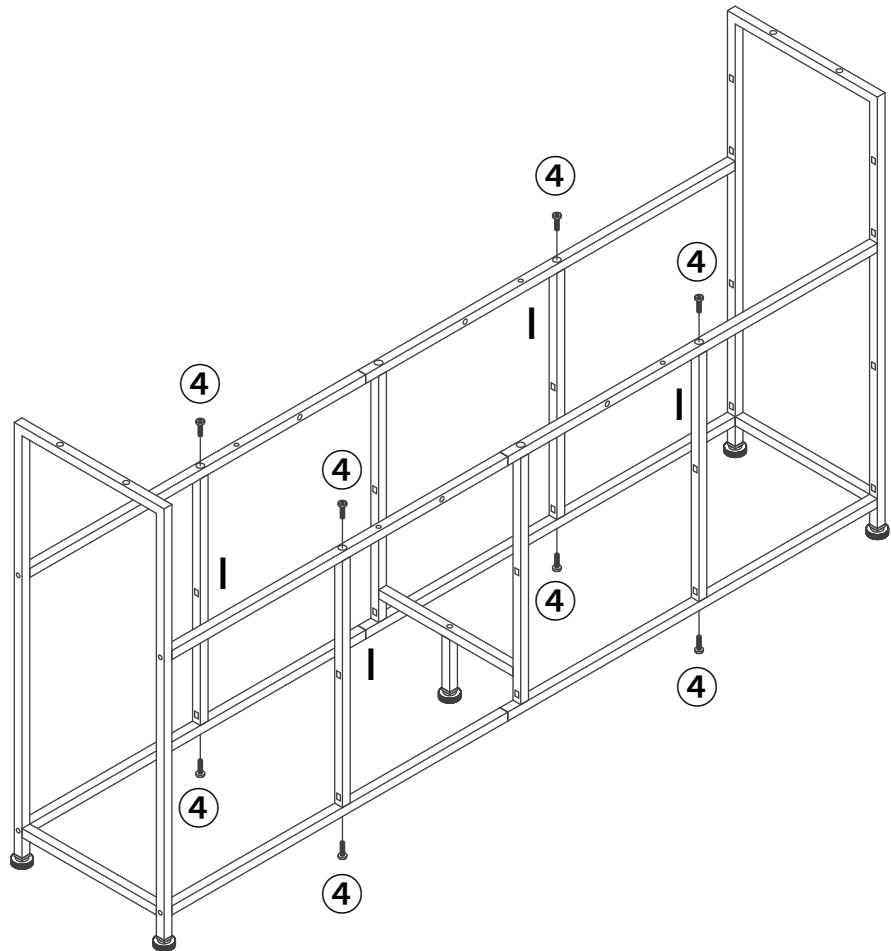
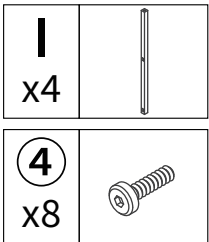

Step10



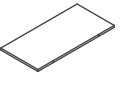

Assembly Instructions

Step 11

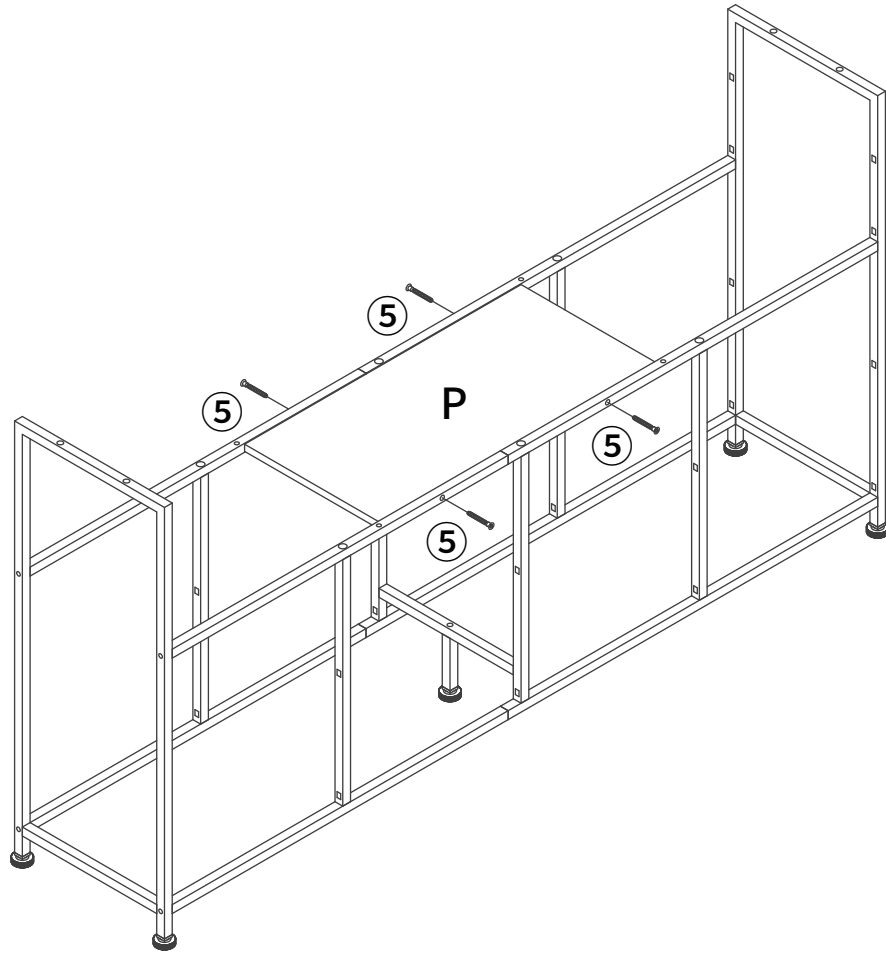
P x1	
5 x4	

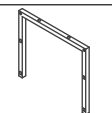
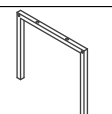

Step 12

B x1	
C x1	
4 x4	

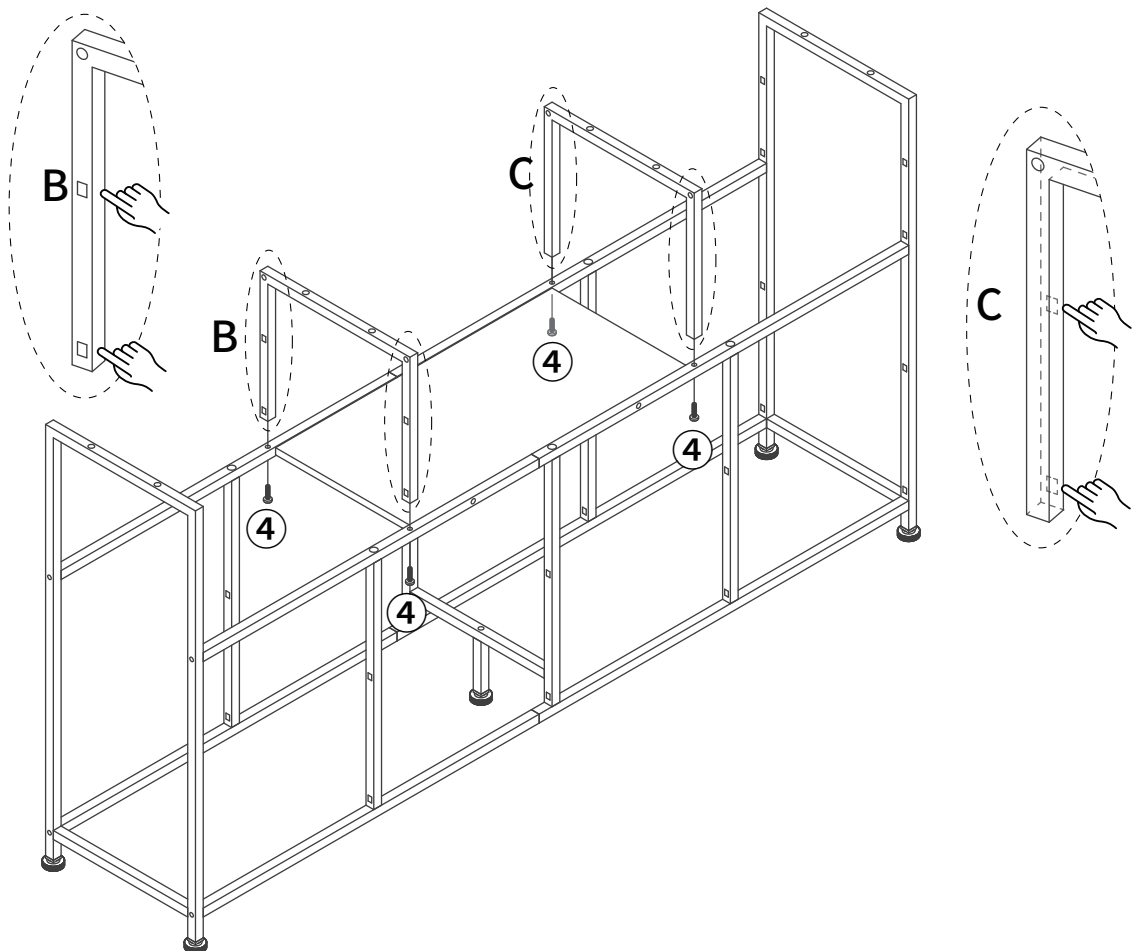

Assembly Instructions

Step13

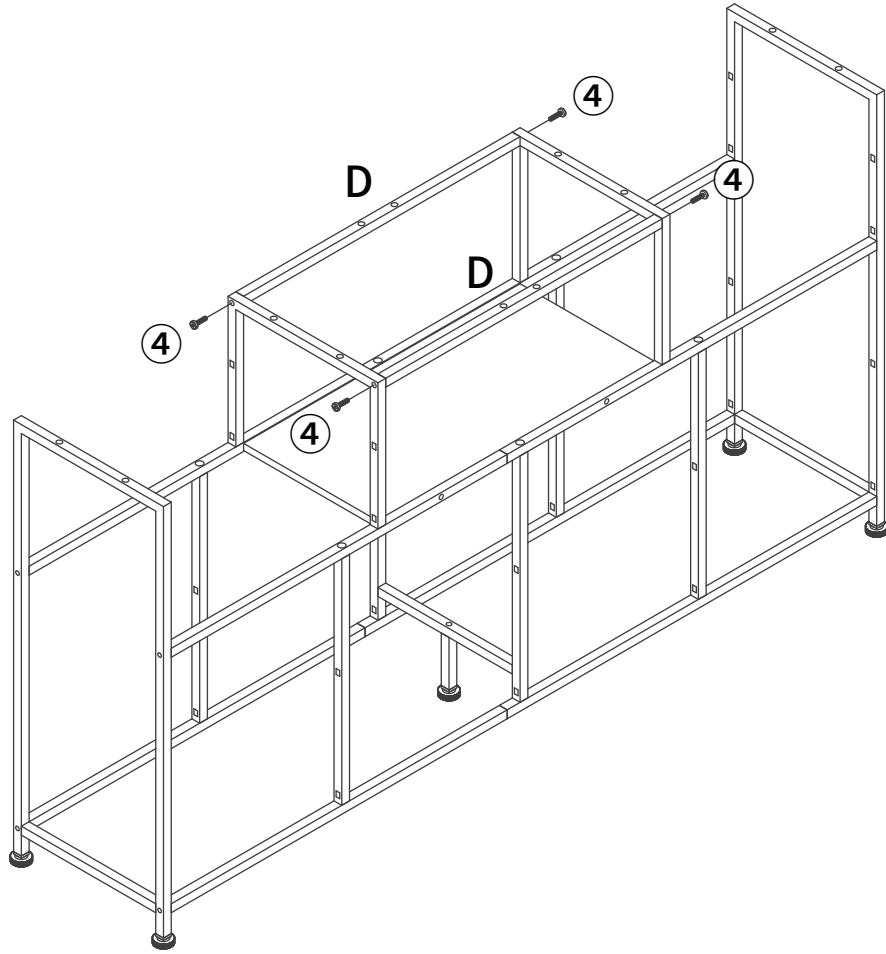
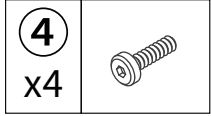
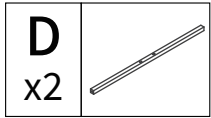

Step14

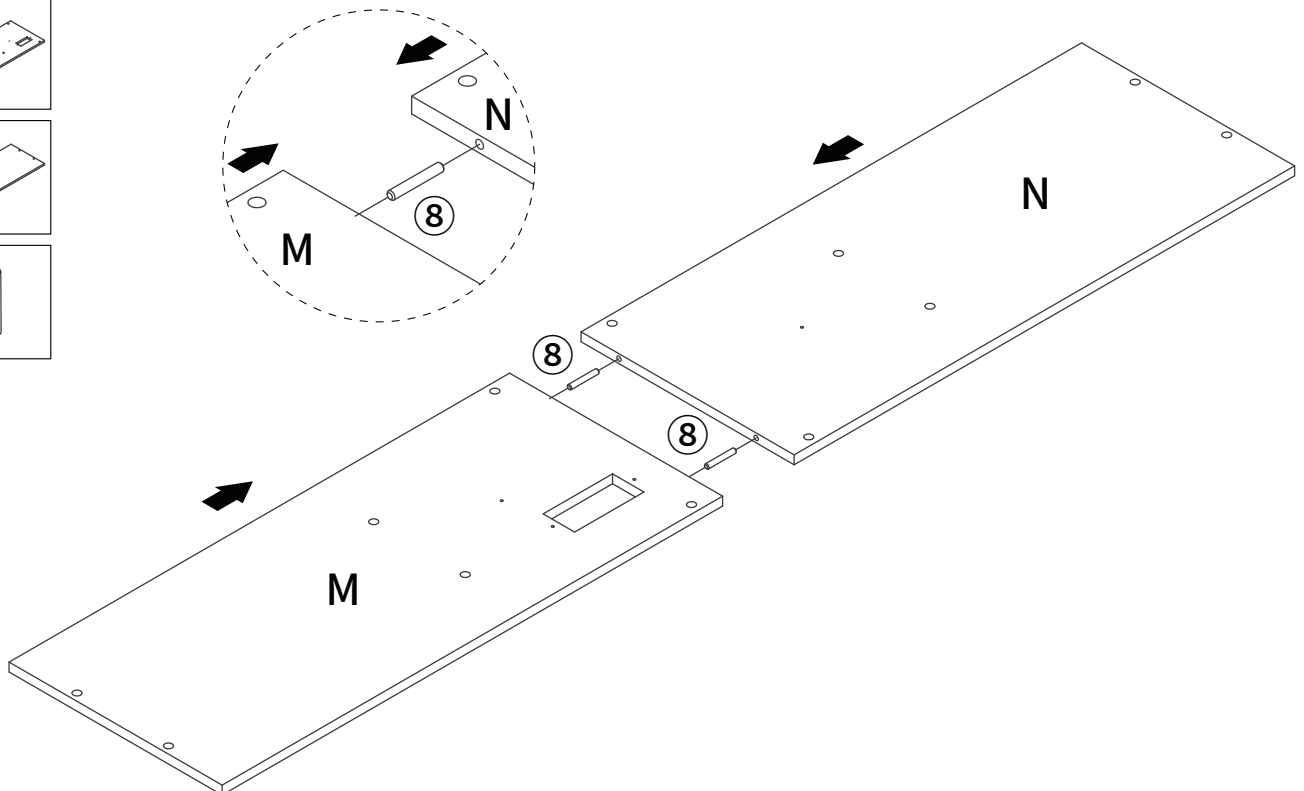
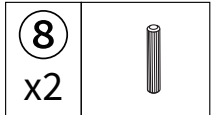
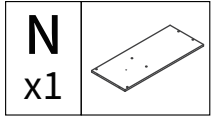
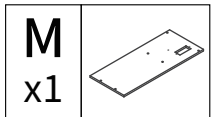

Assembly Instructions

Step15

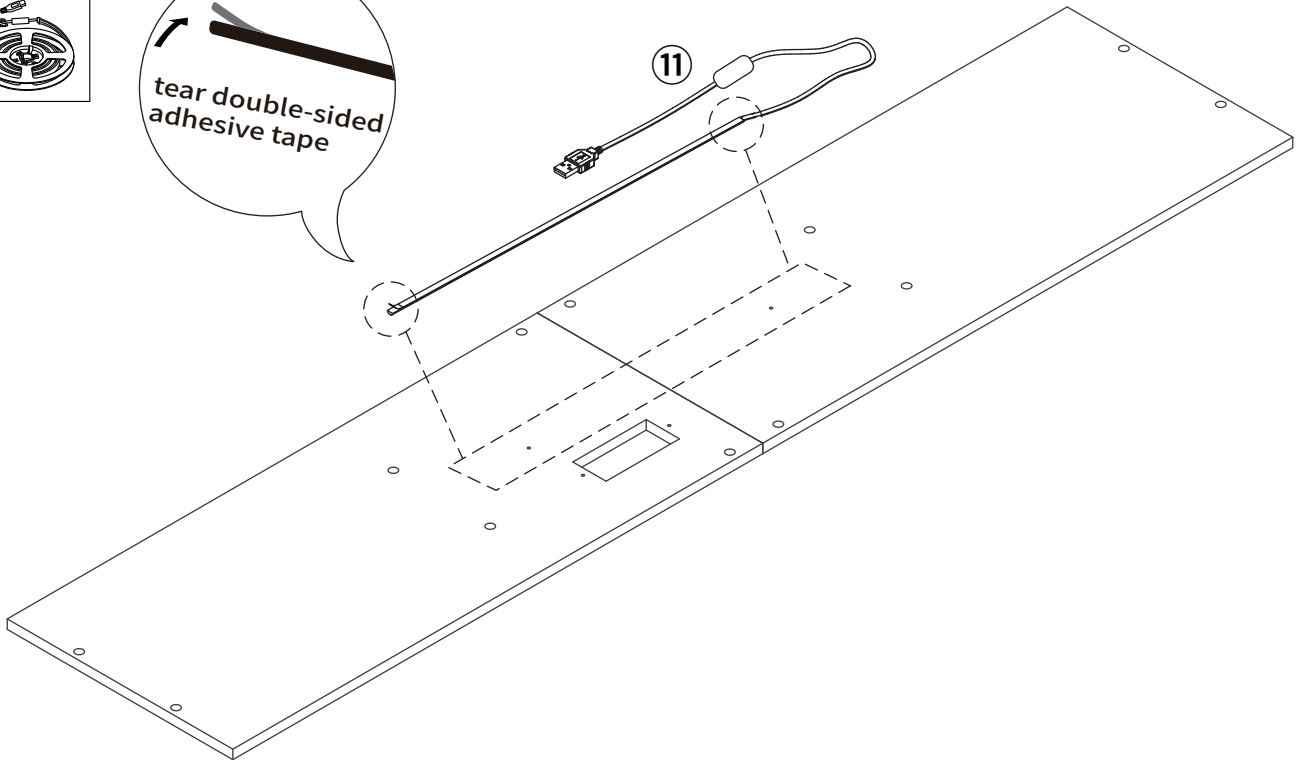
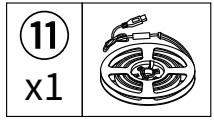

Step16

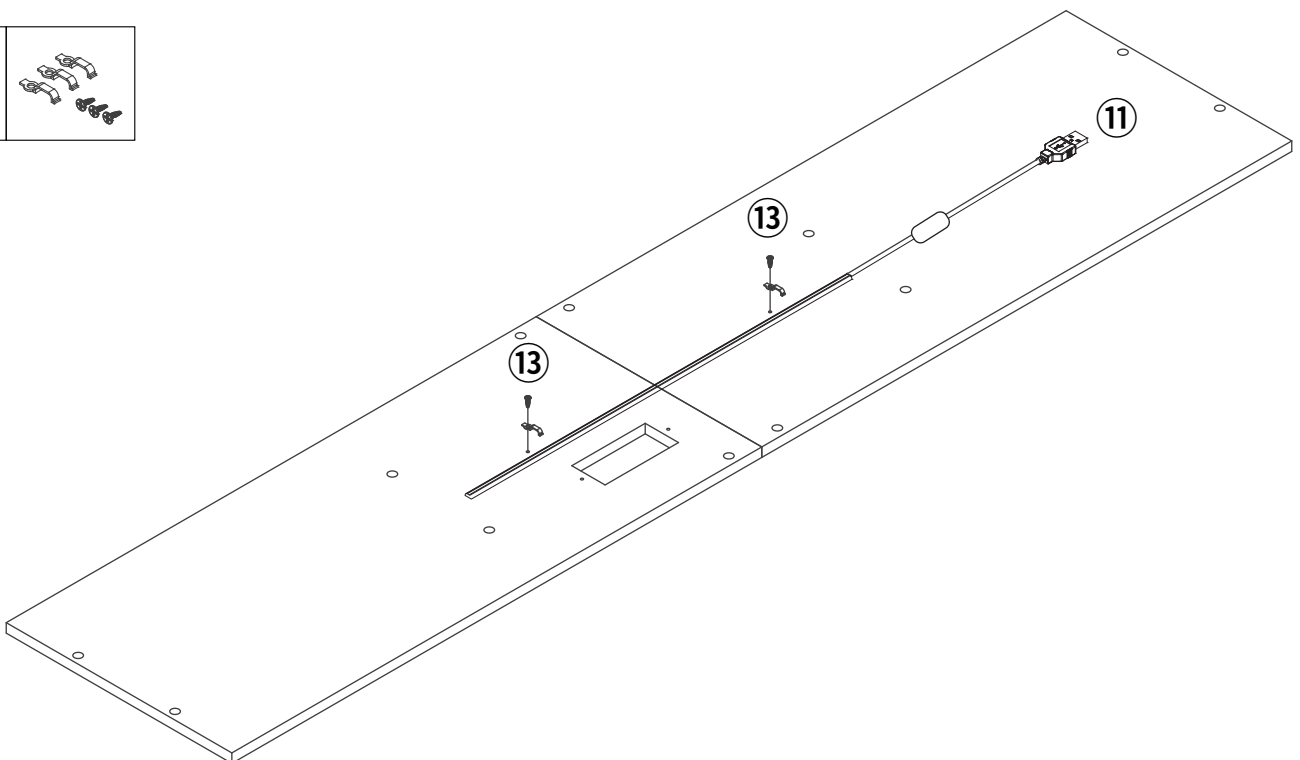
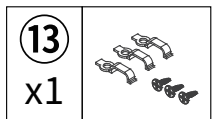

Assembly Instructions

Step17

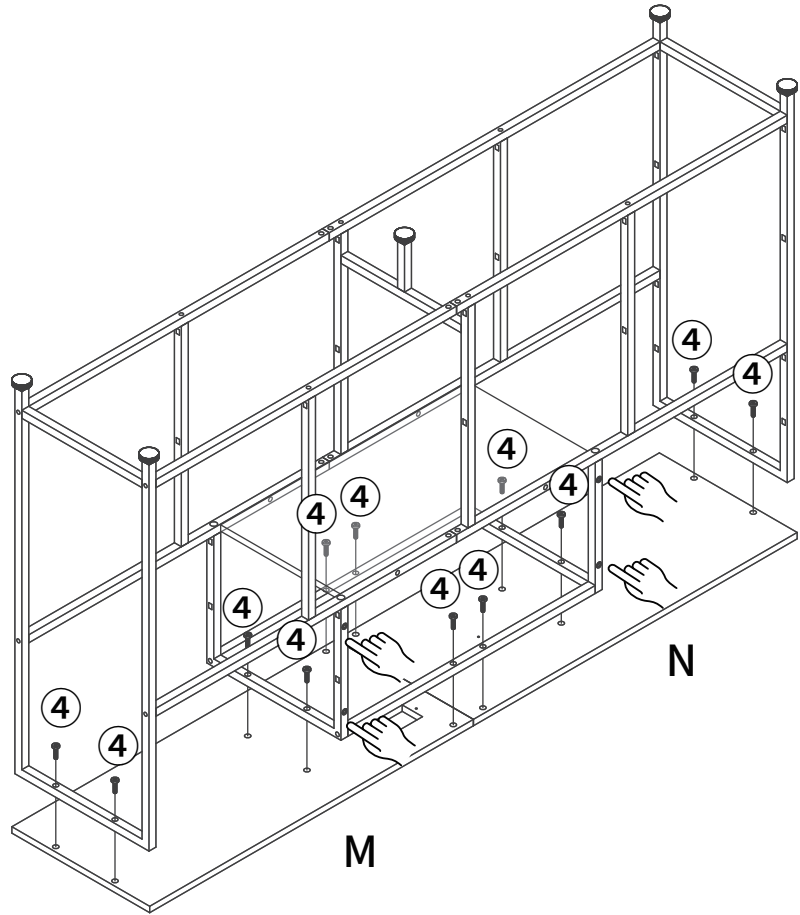
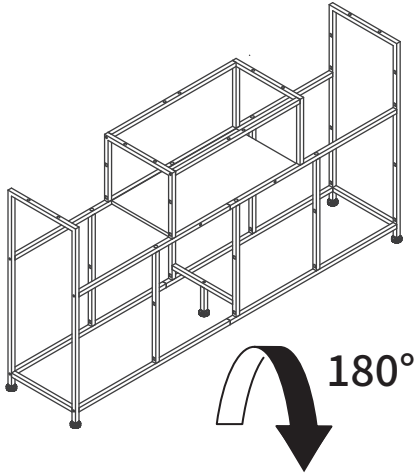
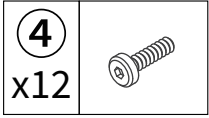

Step18

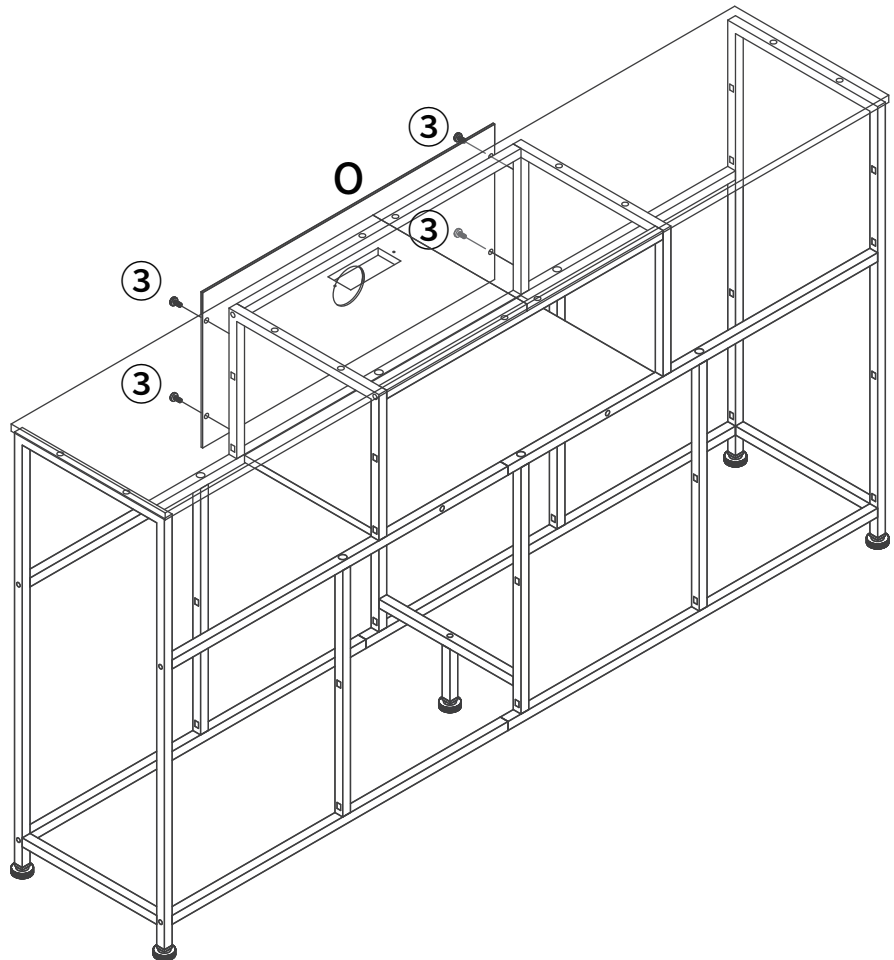
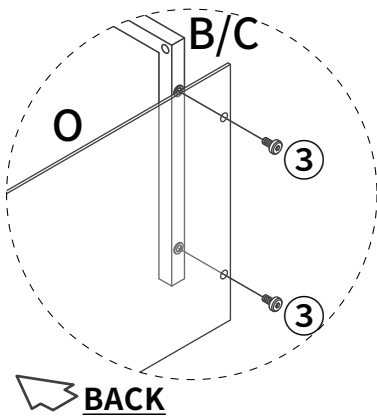
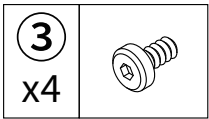
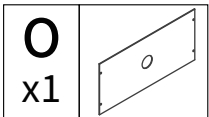

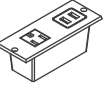

Assembly Instructions

Step19

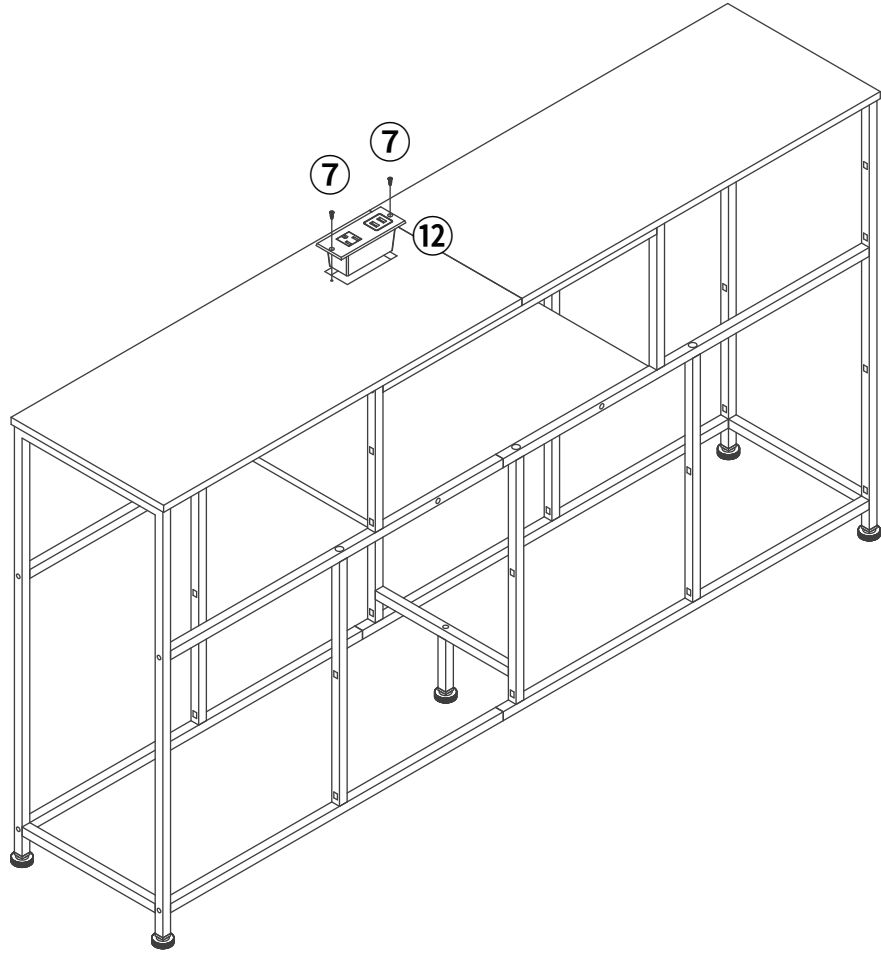
⑦ x2	
⑫ x1	

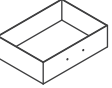
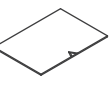
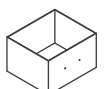
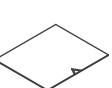

Step20

Q x4	
S x4	
T x8	
U x8	
⑥ x24	
⑩ x12	

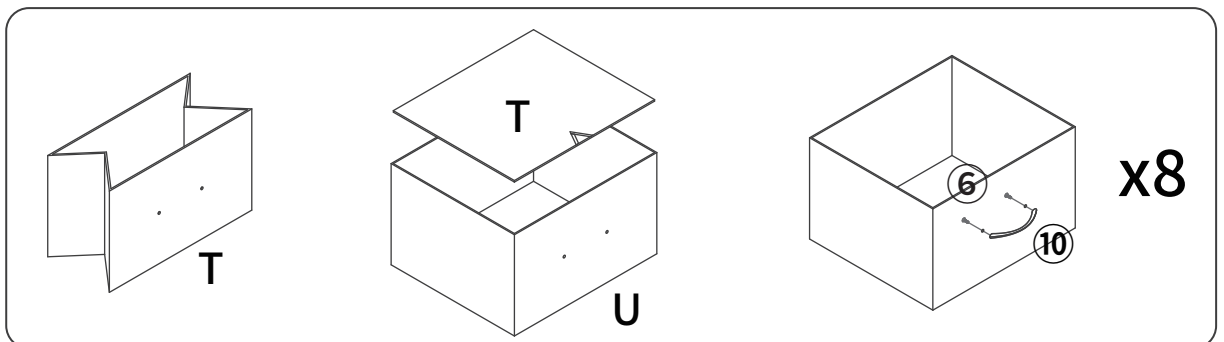
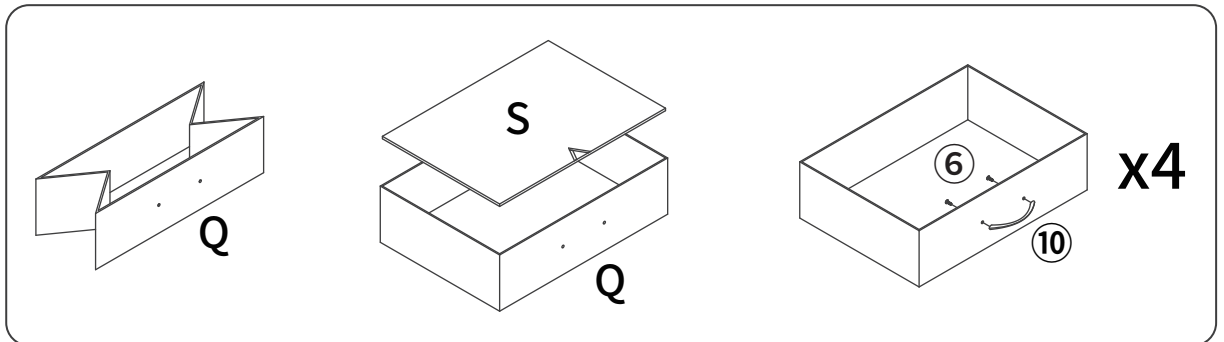

ASSEMBLY INSTRUCTION

- How to distinguish between guide rails L and R.

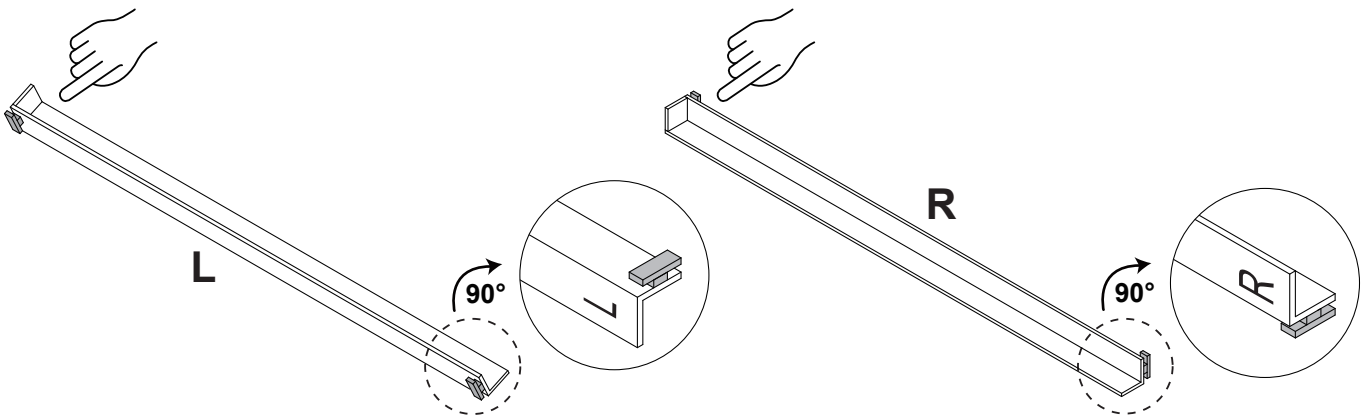

- To install the guide rails, follow the steps and first insert the top of buckles into holes as illustrated.

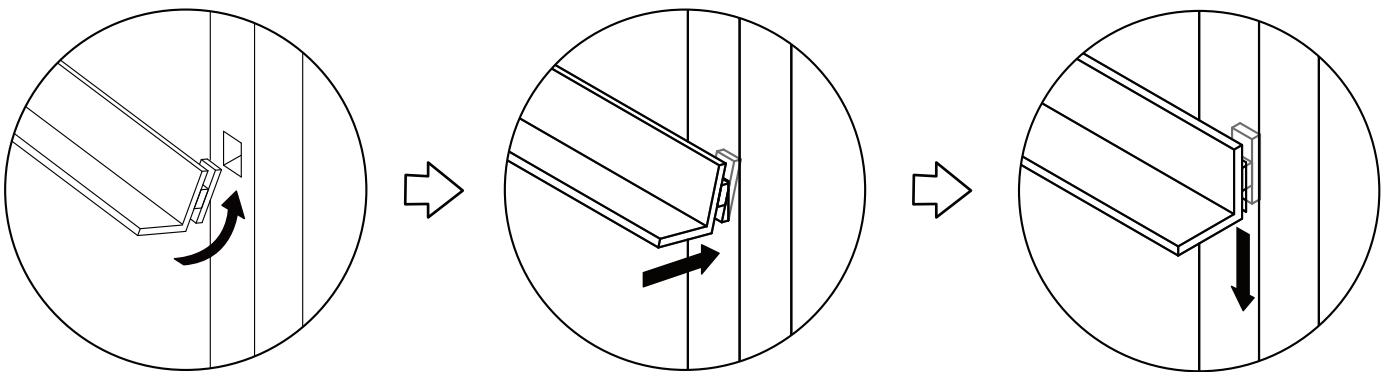

- Refer to the correct installation method.

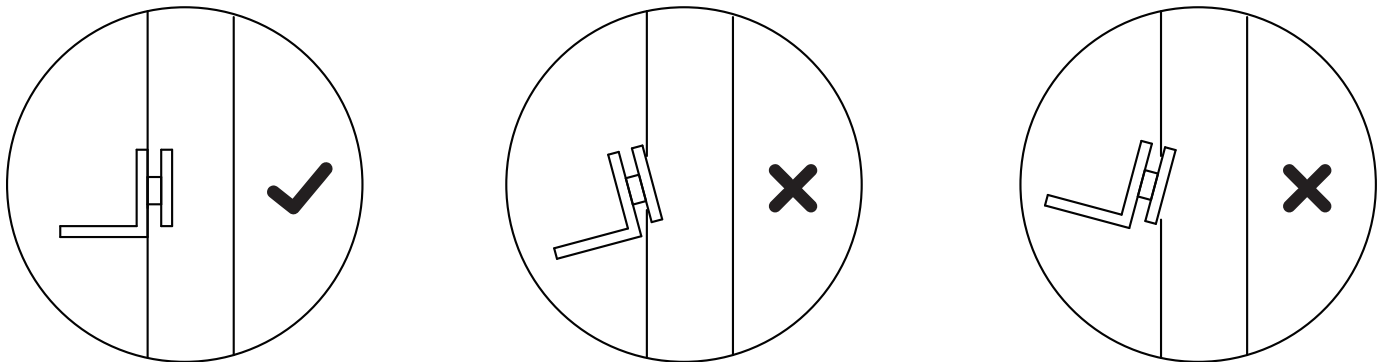

Assembly Instructions

Step21

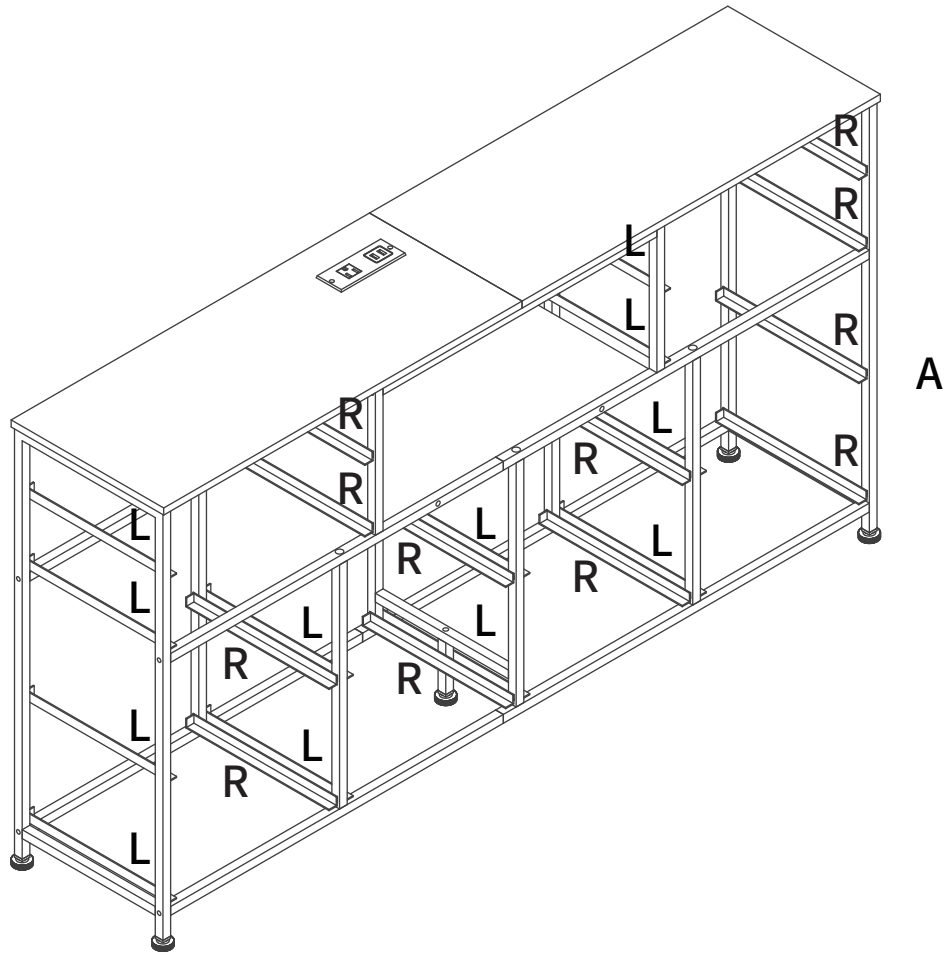
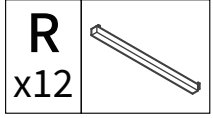
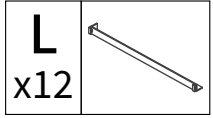

Step22

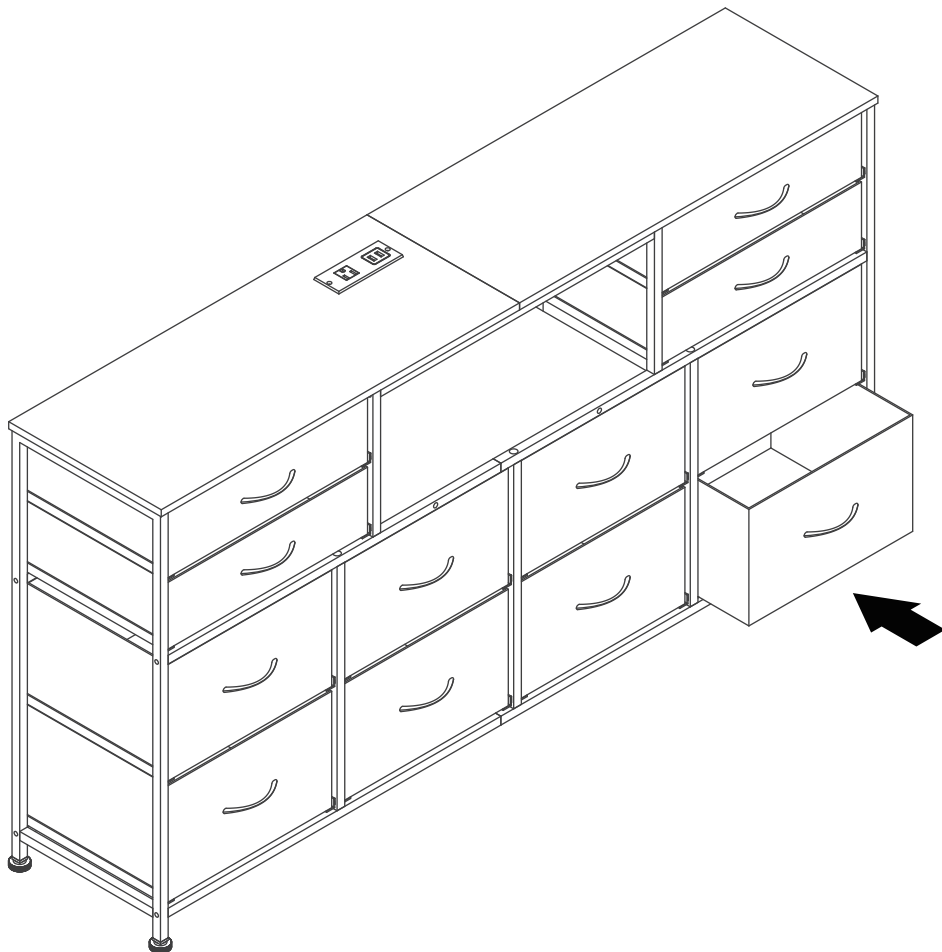

Assembly Instructions

Step 23

