

Instruction Manual

2-Light Wall Lamp

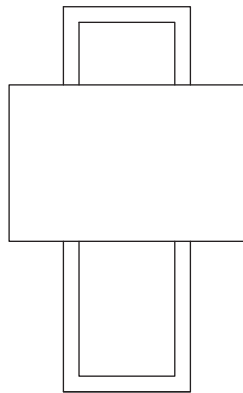

PACKAGE CONTENTS

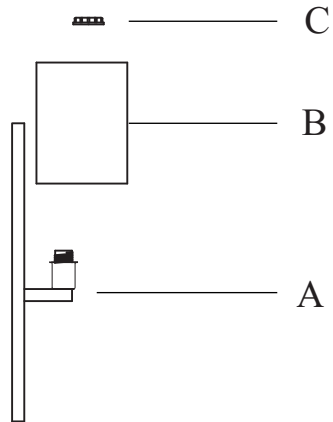

PART	DESCRIPTION	QUANTITY
A	Fixture	1
B	Shade	1
C	Socket ring	1

HARDWARE CONTENTS(shown actual size)

AA

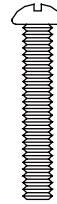

Long
monting x 2
screw

BB



Wire nut x 3

CC



Long
monting x 2
screw

DD

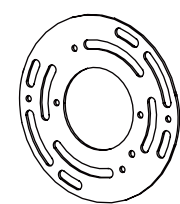

Mounting plate
(Not actual size) x 1

! SAFETY INFORMATION

Please read and understand this entire manual before attempting to assemble, operate or install the product.

! WARNING

- TURN OFF ELECTRICITY at main fuse box (or circuit breaker box) before beginning installation by removing fuse (or switching off circuit breaker).
- MINIMUM 90°C SUPPLY CONDUCTORS.

PREPARATION

Before beginning assembly of product, make sure all parts are present. Compare parts with package contents list and hardware contents list. If any part is missing or damaged, do not attempt to assemble the product.

Estimated Assembly Times: 25 minutes

Tools Required for Assembly (not included): Flathead screwdriver , Phillips screwdriver, Pliers, Electrical tape, Wire cutters, Safety glasses.



Helpful Tools (not included): Wire strippers, Step ladder.

Customer Service: service@24h-reply.com

ASSEMBLY INSTRUCTIONS

1. Attach the mounting plate (DD) to the outlet box (not included) with the long mounting screws (CC).

Hardware Used

- CC Long mounting screw  x 2
- DD Mounting plate  x 1

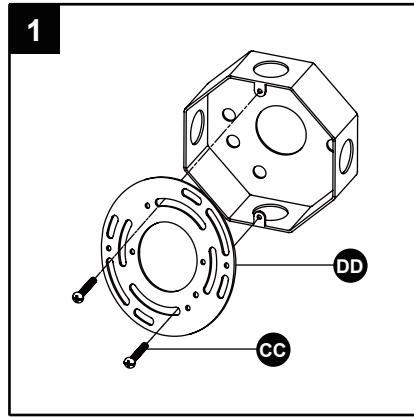

2. Strip 3/4 in. of insulation from wire ends. Twist stripped ends together with pliers (not included), black to black (power) and white to white (neutral). Attach copper wire to ground wire. Helpful hint: If necessary, attach copper ground wire to grounded outlet box.

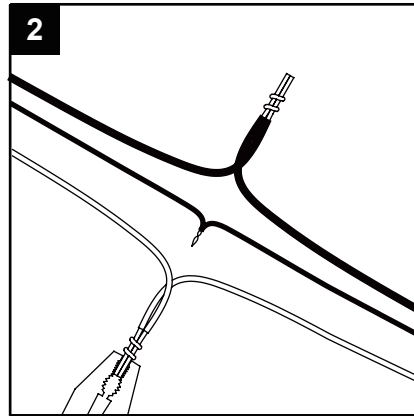

3. Attach wire nuts (BB). Tape wire nuts (BB) and wires together.

Hardware Used

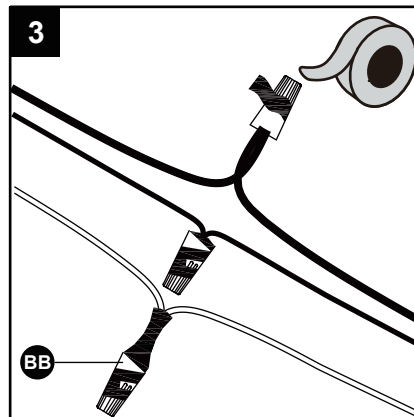

- BB Wire nut  x 3



ASSEMBLY INSTRUCTIONS

4. Align the 2 screws(AA) through the holes of the back plate, and fix them with screw nuts.

Hardware Used

- AA Long mounting screw  x 2
- DD Mounting plate  x 1

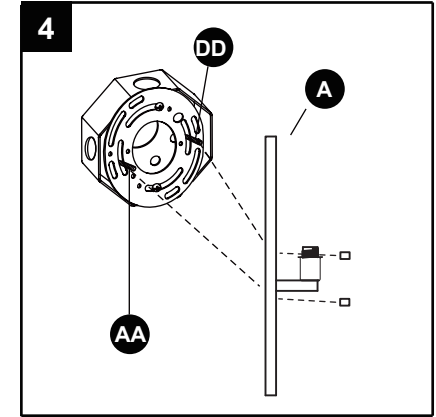

5. Unscrew the socket ring (C), place the lamp shade (B) over the lamp socket, and then screw the socket ring back on to secure it.

