

# Manual

## Notice



Read this assembly manual carefully, and verify that you have all the parts listed before you begin. Keep your assembly manual for future reference.



Move this chair gently with 2 persons.



Protect finishes by placing furniture pieces on a soft carpeted surface during assembly.







Do not place very hot/cold objects on top of any surface. Never leave liquids on the surface: Clean immediately with a mild soap and a damp cloth. Never use scouring powder based cleanser. Don't touch the chair surface with a hard/acute object may cause the chair to damage

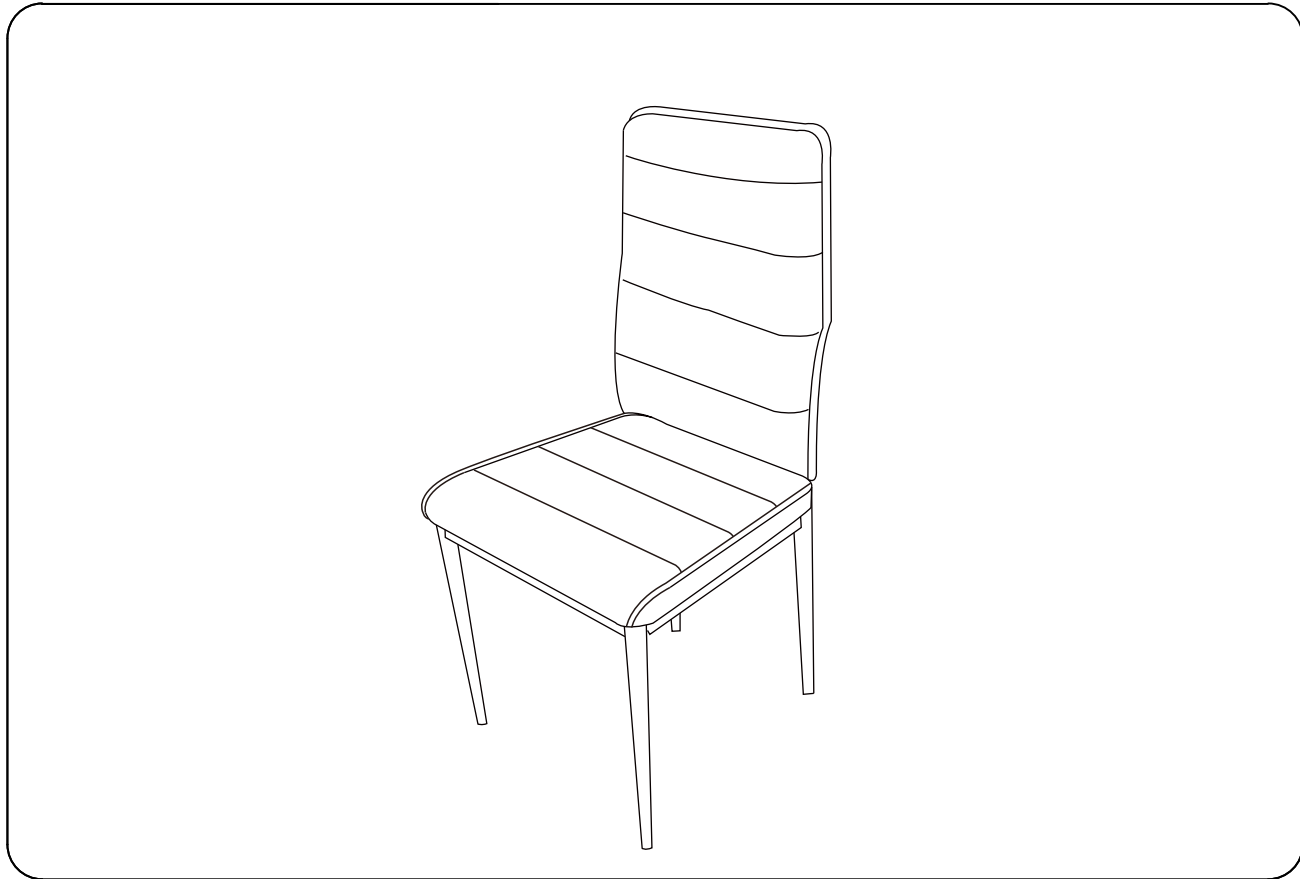

**DO NOT ASSUME CHILD SAFETY WITH ANY PIECE OF FURNITURE!**  
Do not allow children to climb on furniture. Improper use can cause death or serious injury. Damaged parts or furniture put together incorrectly can lead to serious injuries. Make sure to follow instructions correctly.

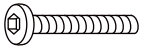

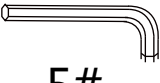
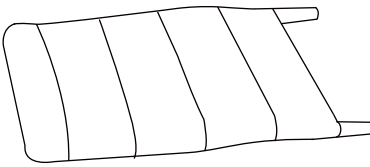
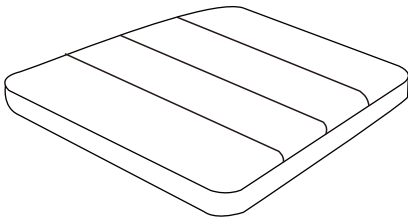
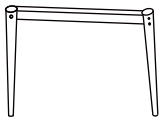
## Parts list

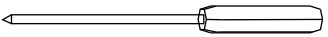
<p><b>A</b>  <b>M4x42</b> <b>X4</b></p>	<p><b>B</b>  <b>M6x40</b> <b>X 2</b></p>	<p><b>C</b>  <b>M6x12</b> <b>X4</b></p>	<p><b>D</b>  <b>5#</b> <b>X1</b></p>
<p><b>E</b>  <b>X1</b></p>	<p><b>F</b>  <b>X1</b></p>	<p><b>G</b>  <b>X1</b></p>	
<p><b>H</b>  <b>X1</b></p>	<p><b>I</b>  <b>X1</b></p>	<p></p>	

1

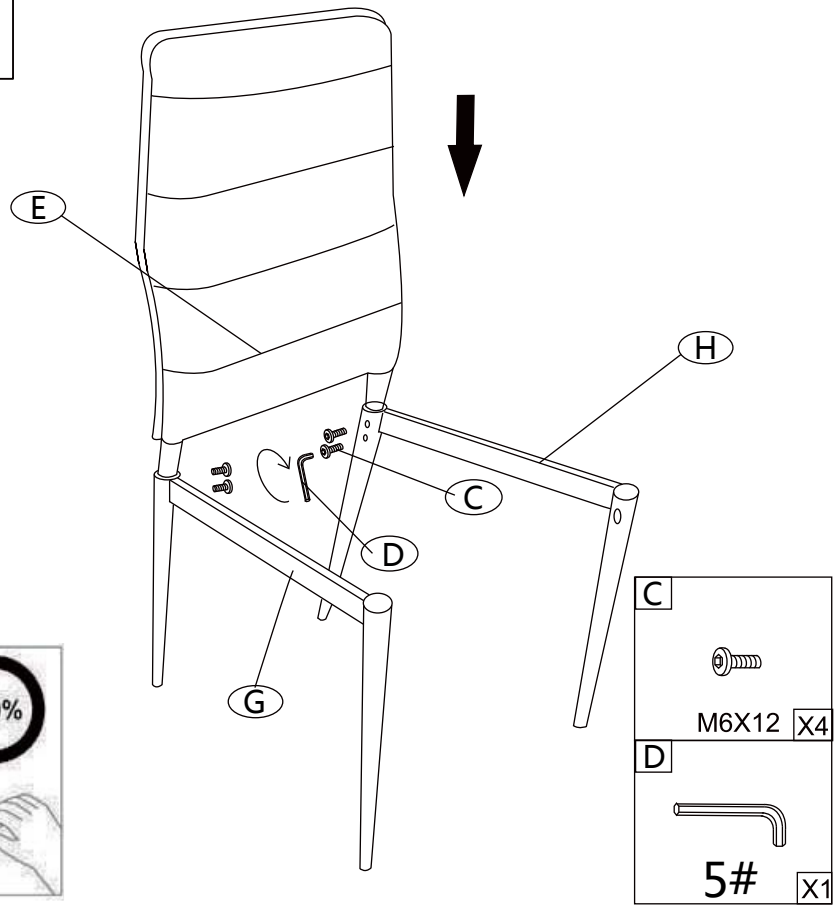

2

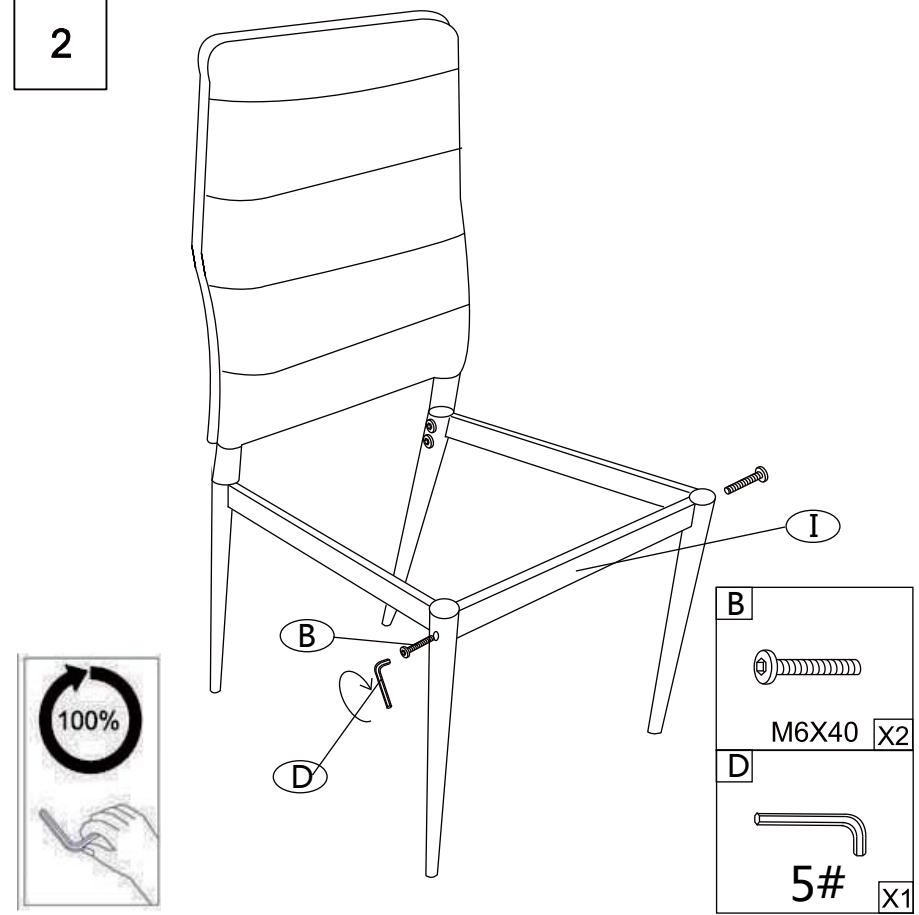

3

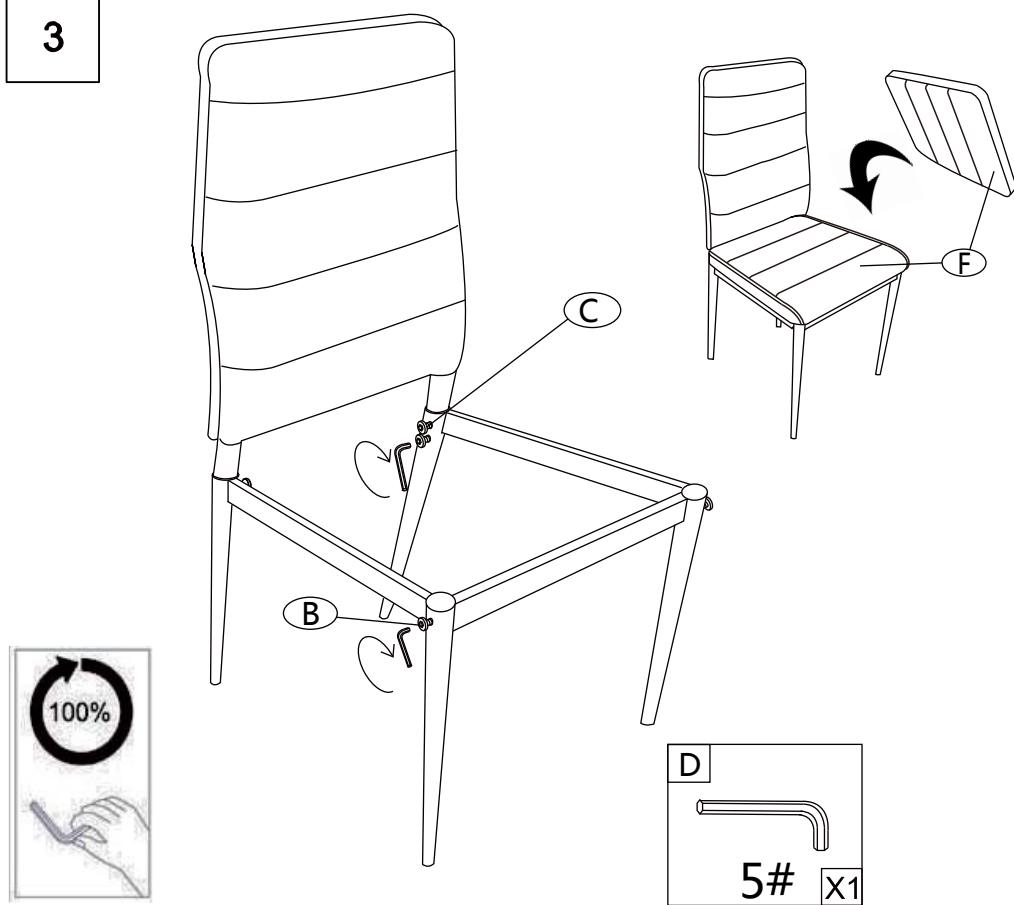

4

