

ASSEMBLY INSTRUCTIONS

✉ support@trendytotesinc.com
☎ 626-679-3588

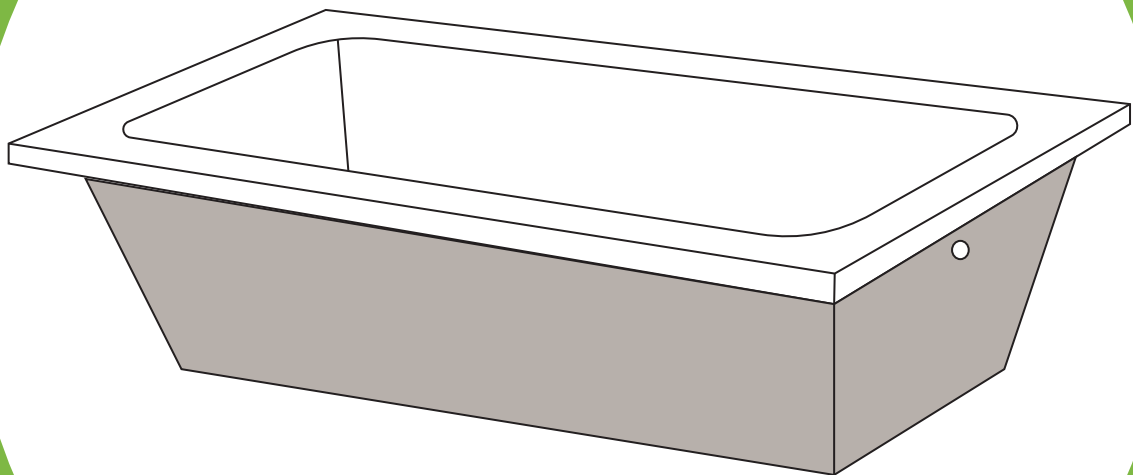

PRODUCT
INSTRUCTION
VIDEO



THANK YOU!

Dear Valued Customer,

Thanks to your kind support of NTQ, we hope our product can improve the quality of your life.

As our valued customer, your comments and opinions are very important to us. If you have any concerns, questions, or comments, we hope that you will bring them to our attention.

Please keep the carton and packaging materials until your product is completely installed.

Feel free to contact us if you encounter any problems such as missing parts, or product defects during the installation process. We are happy to provide you with the most sincere service.

*Sincerely,
Service Team*



Please read all instructions carefully before proceeding with installation.



Due to the complexity of the installation procedure, a professional plumber is required.

TABLE OF CONTENTS

1. Pre-installation Checklist	P3
2. Tools Required	P6
3. Installation Instructions	P7
4. Care & Maintenance	P14
5. Warranty	P16

PRE-INSTALLATION CHECKLIST

1. Materials and Tools

- **Bathtub:** Ensure you have the correct size alcove bathtub.
- **Drain Assembly:** It's included with our bathtub
- **Faucet and Fixtures:** Make sure you have the tub faucet, spout, and showerhead (if applicable).
- **Plumber's Putty:** For sealing the drain.
- **Silicone Caulk:** For sealing the edges after installation.
- **Construction Adhesive or Mortar**
- **Tile Backer Board** (if tiling around the tub).
- **Waterproofing Membrane**
- **Tools:** Level, measuring tape, drill, screwdriver, adjustable wrenches, notched trowel, caulk gun, safety goggles, and gloves.

2. Access and Preparation

- **Access to Plumbing:** Confirm that you have access to the existing plumbing for the drain and faucet.
- **Electricity:** Ensure there are no electrical wires in the way of your installation.
- **Clear Work Area:** Remove any obstacles from the installation area, including old fixtures, flooring, and debris.
- **Subfloor Assessment:** Check the condition of the subfloor; it should be leveled and structurally sound. Repair any damaged areas.

3. Space Measurements

- **Measurements:** Measure the alcove space to ensure your new bathtub fits correctly.
- **Clearance:** Check for space around the sides of the tub for installation and maintenance.

4. Plumbing Check

- **Drain Alignment:** Confirm that the existing drain pipe aligns correctly with the drain on the new bathtub.
- **Shut-off Valves:** Make sure water supply valves are functioning properly and accessible.

5. Ventilation and Safety

- **Ventilation:** Ensure the workspace is well-ventilated to avoid inhaling fumes from adhesives and caulk.
- **Safety Gear:** Have safety goggles and gloves on hand to protect yourself during the installation.

6. Inspection and Requirements

- **Manufacturer's Instructions:** Read and understand the manufacturer's installation instructions specific to your bathtub model.
- **Local Building Codes:** Familiarize yourself with local building codes and regulations regarding bathtub installations.

7. Additional Considerations

- **Plan for Tiling (if applicable):** If tiling around the tub, ensure you have the appropriate materials for the surround.
- **Decide on Accessory Installation:** If you plan to install shelves, grab bars, or other accessories, ensure you have those materials ready.
- **Help Available:** Plan for additional help if needed, as bathtubs can be heavy to install alone.

Final Steps

Once you've completed this checklist and ensured that you have everything needed, you're ready for the installation process. Taking the time to prepare adequately will help ensure your alcove bathtub installation goes smoothly and successfully. Good luck with your project!

TOOLS REQUIRED



Level



Jigsaw



Tape Measure

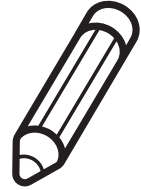

Pencil



Power Drill

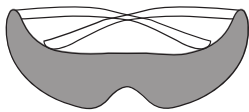

Safety Goggles



3/16" (5mm)
Drill Bit



No 8 x 1 1/4 "
Screws



Construction
Adhesive



Mortar
Compound

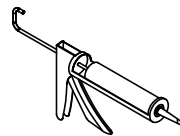

Silicone caulk

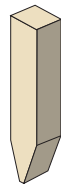

Furring strips

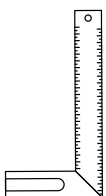

Square

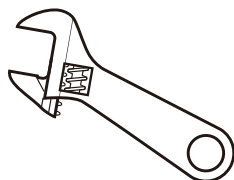

Adjustable Key

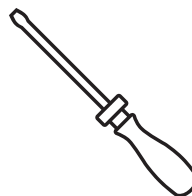

Screwdriver

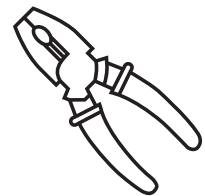

Furring strips

Step1: Construct Frame

- Build framing according to the size of your tub.
- When building frame, keep in mind access to drain connections and faucet location, an access panel may be needed depending on location.
- A mixing valve may be required, check with your local plumbing codes.

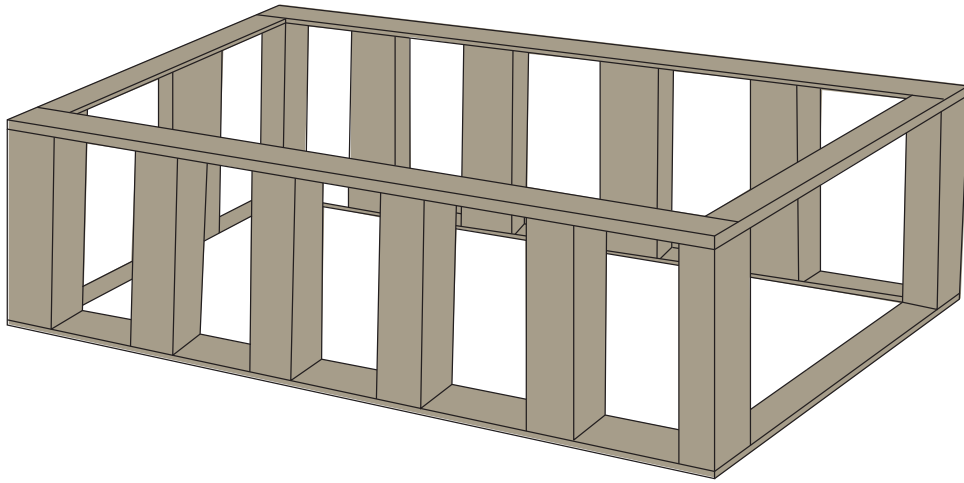

Step2: Rough-In

- Rough plumbing must be installed before installing the bathtub.
- Floor and drain trap are not included, make sure to install according to local and legal regulations.
- Do not connect drain to plumbing yet.



Step3: Lay Plastic Film

- Lay plastic film on sub floors to prevent water from being absorbed.
- Depending on drain location (right or left), a 6" x 12" rough opening should be cut in the floor for later hookup.

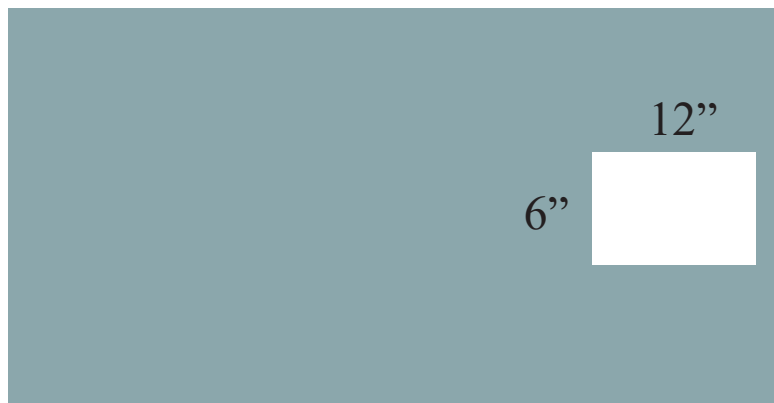
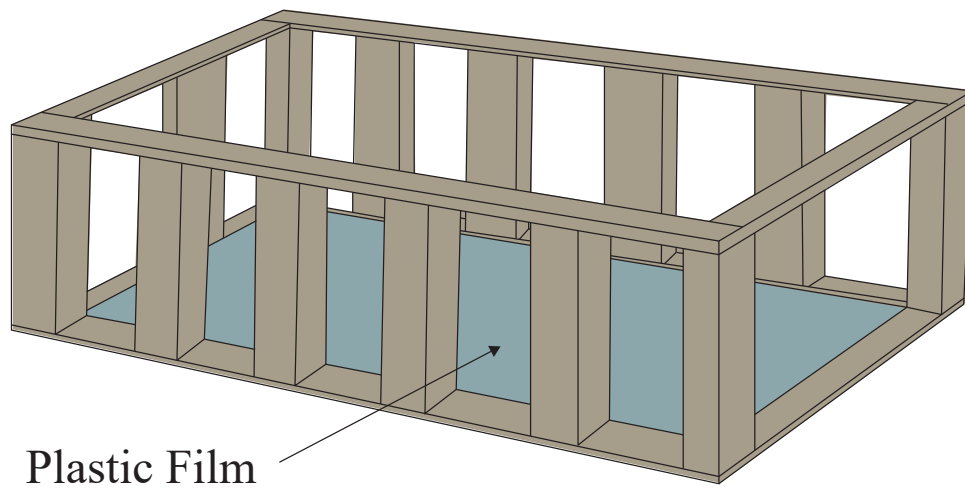

Step4: Drop Tub into Frame

- If tile or stone is to go on deck surface, this must be done before installing bathtub, consult with a professional if necessary.
- Carefully lift the bathtub and slowly drop into place.
- Ensure tub is level on all sides. Check everything thoroughly and adjust as needed.

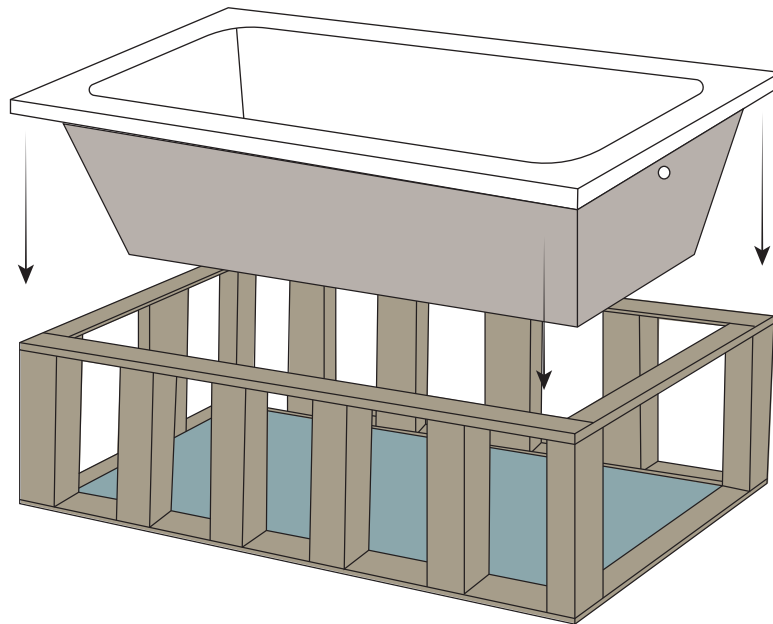

Step5: Fill Gaps

- Once bathtub is ready to install it is recommended to fill any gaps between the bathtub and the floor (use struct-o-lite or a bed of mortar).
- Do not overfill the gap, this will make the bath tub fit improperly in the deck.

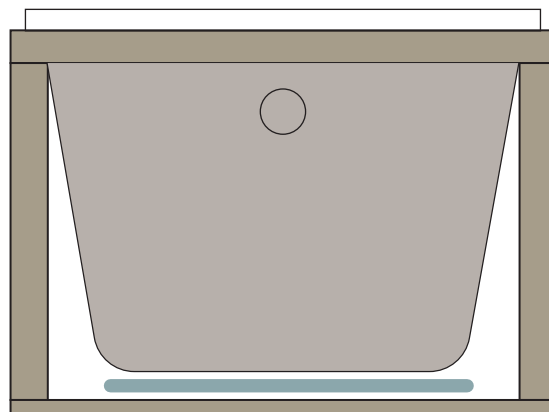

Step6: Connect Plumbing

- Install waste and overflow to drain assembly.
- Connect 1 1/2" trap below floor.
- Install the faucet (not included) according to manufacturer's instructions and check for leaks.

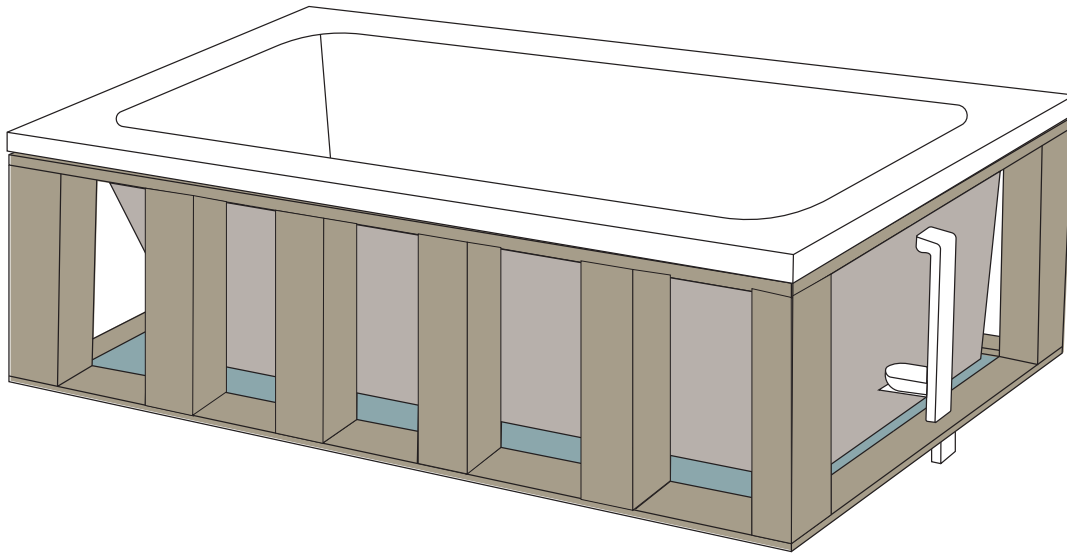

Step7: Seal

- Once all connections are made it is recommended to seal the bathtub to the deck.
- Apply a bead of sealant and wipe away excess.
- Place drop cloth in bathtub and stand inside bathtub to press it into floor when securing to wall studs.

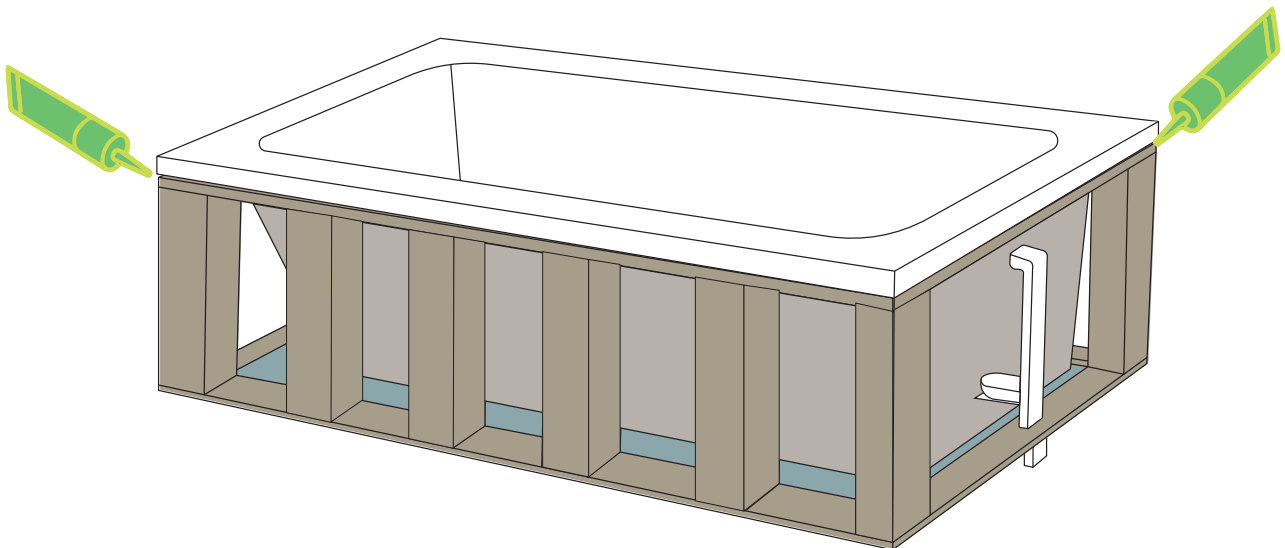

CARE & MAINTACE

Caring for and maintaining your alcove bathtub is essential to keep it looking great and functioning well for years to come. Here are some tips and guidelines for proper care and maintenance:

1. Rinse After Use: After each use, rinse the tub with warm water to remove soap scum, hair, and other residues. This helps prevent buildup and staining.

2. Wipe Down: Use a soft cloth or sponge to wipe down the surfaces of the tub after rinsing to eliminate any remaining moisture. This can help prevent mold and mildew.

Weekly Maintenance

3. Regular Cleaning: Use a non-abrasive cleaner formulated for your specific bathtub material (e.g., acrylic, fiberglass, porcelain). Avoid harsh chemical cleaners that can damage the surface.

4. Scrub Gently: With a soft-bristle brush or sponge, scrub the tub gently to remove soap scum and mineral deposits. Pay special attention to areas around the drain and faucet.

5. Check for Mold and Mildew: Inspect corners and crevices for signs of mildew or mold. If you notice any, use a mold cleaner or a mixture of water and vinegar to treat the area.

Monthly Maintenance

6. Inspect Seals and Caulking: Check the caulking around the tub, especially where it meets the walls and the floor. Look for cracks or gaps that might allow water to seep behind the tub. If you find any issues, reapply silicone caulk to create a watertight seal.

7. Drain Maintenance: Occasionally, check and clean the drain, removing any hair or debris that may have accumulated. You can also use a mixture of baking soda and vinegar to keep the drain clear. Pour it down the drain, wait a few minutes, then flush with hot water.

Seasonal Care

8. Deep Cleaning: Every few months, consider doing a deeper cleaning of the tub. You can use a mild bleach solution (following the manufacturer's guidelines) or a specialized bathtub cleaner.

9. Check for Wear and Tear: Periodically inspect your bathtub for any signs of chips, scratches, or fading. If you notice any damage, address it promptly to prevent further deterioration.

Additional Tips

- **Avoid Harsh Chemicals:** Do not use abrasive cleaners, scouring pads, or harsh chemicals, as they can scratch or dull the surface of the bathtub.
- **Be Mindful of Bath Products:** Some bath oils and bubble baths can cause film buildup on the tub. Use products that are gentle and designed for use in bathtubs.
- **Temperature Changes:** Avoid drastic temperature changes, like pouring boiling water directly into a cold tub, as this can cause damage.

10. Avoid Scratches and Damage:

- Use a soft cloth or sponge when cleaning the bathtub to prevent scratches on the acrylic surface.
- Avoid using abrasive scrubbing pads, brushes, or harsh cleaning tools that can scratch or damage the acrylic material.
- Do not place sharp or heavy objects directly on the bathtub surface, as they can cause scratches or dents.

11. Preventing Stains:

- To prevent stains, avoid leaving soap, shampoo, or other bath products sitting on the bathtub surface for extended periods. Wipe up spills promptly.
- Use a bath mat or rug inside the tub to prevent scratches and to absorb excess water, which can cause water spots and stains.

12. Temperature and Chemicals:

- Do not use hot water above 120°F (49°C) when cleaning the bathtub, as excessive heat can damage the acrylic material.
- Avoid using harsh chemicals, bleach, ammonia, or abrasive cleaners on the acrylic surface, as they can cause discoloration and damage.

13. Maintenance:

- Inspect the bathtub regularly for any signs of damage, cracks, or leaks. Address any issues promptly to prevent further damage.
- Keep the bathtub well-ventilated to prevent mold and mildew growth. Wipe down the surface and walls of the bathtub after each use to remove excess moisture.

By following these care and maintenance tips, you can keep your alcove acrylic bathtub looking clean, pristine, and in good condition for years to come. Proper care and regular maintenance will help extend the life of your bathtub and ensure a relaxing and enjoyable bathing experience.

LIMITED WARRANTY COVERAGE

1 YEARS LIMITED WARRANTY

BESTGO products are made with quality materials and excellent craftsmanship to provide the customers a long-lasting product. In the case of any defects in materials or craftsmanship under regular use were inspected in the first one year of delivery, BESTGO will provide replacement parts at no charge, or at its option, replace any product or part of the product that is deemed defective, under normal installation, use, service and maintenance. This warranty applies only to the original purchaser. Proof of purchase will be required in the case of a claim.

BESTGO will, as its option

- (1) Repair or replace the defective part(s) or product(s) at no charge;
- (2) Issue a refund of the original purchase price of the product(s) (Valid within 30 days from the date of delivery);
- (3) Issue a credit to be applied toward the purchase of a new BESTGO product shipping/delivery charges may apply and are in BESTGO's sole discretion.

BESTGO recommends the installations to be made by a licensed, professional plumber. BESTGO will not be held responsible for any damage or product failure due to improper installation, misuse, or failure to use a licensed professional. BESTGO is not responsible for any removal or installation cost.

This limited warranty shall not apply to goods that have been subject to accident, negligence, improper installation, product abuse, product misuse, or use of cleaners containing abrasives, alcohol or other organic solvents, whether performed by a contractor, service company, or yourself, are excluded from this warranty.

BESTGO responsibility under this limited warranty is limited to only to replacement parts and no other costs.

BESTGO will not be responsible for labor charges and/or damage incurred by installation, repair, or replacement, nor for any indirect incidental or consequential damages, losses, injury, or costs of any nature relating to this product.

Except as provided by law, this limited warranty is instead of and excludes all other warranties, conditions, and guarantees, whether expressed or implied, statutory or otherwise, including without restriction those merchant ability of fitness for use.

RESPONSIBILITIES OF OTHERS

Inspecting the unit before installation is the responsibility of the installer or building contractor who acts on behalf of the user. They are responsible for ensuring the unit is free of defects or damage.

Notices are placed on and in the unit and on the shipping carton advising the installer of this responsibility. In the event of a problem, the unit must not be installed.

BESTGO is not responsible for failures or damage that could have been discovered, repaired, or avoided by proper inspection and testing before installation.

Damage occurring in transit is the responsibility of the carrier. The user or installer **MUST** open the crate and inspect the unit for damage when it's delivered. If damage is discovered, it must be reported immediately to the seller and the carrier in writing, and an inspection requested. Failure of the carrier to respond should be reported to the seller and the carrier. Your freight claims should be filed promptly thereafter.

LIMITATIONS AND EXCLUSIONS

This warranty does not cover instances of negligence, misuse, abuse, improper installation, carelessness, accident, hard water or mineral deposits, exposure to corrosive materials, misapplication, damages caused by improper maintenance, alteration of the product, or failure to follow care or installation instructions enclosed with your product.

This warranty is void if the BESTGO is subject to alteration, or if repairs are attempted by anyone other than an authorized agent of BESTGO. This warranty does not extend to plumbing or components installed by dealers, installers or by any party other BESTGO.

BESTGO will not be liable for loss of use of the BESTGO inconvenience, or any other incidental or consequential costs, expenses, or damages. Please note that some states do not allow the exclusion or limitation of incidental damages.

DISCLAIMER

Except as expressly provided, there shall be no warranty or obligation, express or implied, oral or statutory. No dealer or other person has the authority to make any warranties or representations concerning BESTGO or its products. In no event shall BESTGO be held responsible for any such warranties or representations.

WARRANTY SERVICE

NOTE: When requesting a warranty, be sure to have the following:

- Copy of original invoice
- Date of installation
- Description and pictures of the defect
- Model number or description of the model

To obtain warranty service and replacement parts, please contact BESTGO Customer Service. BESTGO will determine whether to repair or replace your product, issue a refund, or issue a credit.

WARNING: Content may contain sharp and other possibly harmful pieces and may cause hazard to children and adults, BESTGO is not responsible in any way for personal damage.

Drain & Pipe Installation Guide

1. Attach the strainer upper gasket (Q) to the strainer (C). Spread silicone sealant (not included) along the underside flange of the strainer (C). Align the drain elbow (D) and the rubber drain washer (E) from underneath the bathtub drain hole. Insert the strainer (C) into the drain hole and securely attach it from underneath the bathtub to the rubber drain washer (E) and to the drain elbow (D). Use pliers or a strainer wrench (not included) to tighten it.
2. Position a slip nut (G) and washer (H) onto the drain elbow (D), orienting the threads of the slip nut and the beveled edge of the washer toward the end of the tube.
3. Slide a slip nut (G) and washer (H) onto the overflow elbow (A), ensuring that the threads of the slip nut and the beveled edge of the washer are oriented toward the end of the tube.
4. Next, position the rubber overflow washer (B) onto the overflow elbow (A), with the thicker lip facing the overflow elbow's upper part, as indicated in the drawing.
5. Insert the longer arm of the retainer clips (Y) into the slots located just below the screw holes on the overflow elbow (A).
6. Measure from the center of the overflow hole to the bottom of the bathtub, where the drain elbow (D) will connect to the waste tee (F). Determine if the extension tube (N) is needed based on the measured height.
7. If the extension tube (N) is needed for the desired overflow height, insert the overflow elbow (A) into the extension tube (N), and carefully tighten the slip nut (G) without over-tightening. Then, position a slip nut (G) and washer (H) on the extension tube (N), orienting the threads of the slip nut and the beveled edge of the washer toward the end of the tube. Insert the extension tube (N) into the waste tee (F) and gently tighten the slip nut (G) without over-tightening. ^{7a}. Please note that the extension tube (N) can be cut if necessary to fit the bathtub properly.
8. If the extension tube (N) is unnecessary, refrain from using it. Instead, insert the overflow elbow (A) into the waste tee (F) and gently tighten the slip nut (G) without over-tightening.
9. Position the overflow elbow (A) over the overflow hole from the bathtub's exterior.
10. Connect the trip lever linkage (J) to the trip lever faceplate (K) by aligning the holes and inserting the cotter pin (U). Then, using pliers, twist the pin to secure the connection.
11. From the interior of the bathtub, insert the linkage assembly (J) and the faceplate (K) through the overflow elbow (A). The drain assembly includes four linkage wires (1-4) to establish the suitable height of the linkage assembly. Refer to the next page of the installation manual to identify the correct wire based on the bathtub's soaking depth. If necessary, adjust the linkage length by turning the threaded rod (M).
12. With the trip lever set to the closed position, ensure that the plunger (P) rests on the internal stop of the waste tee (F).
13. Secure the trip lever plate (K) to the overflow elbow (A) by using the two overflow plate screws (S).
14. Verify the functionality of the plunger mechanism by raising and lowering the trip lever handle (L).
15. Install the strainer grid plate (R) and fasten it securely using the strainer grid screw (T).
16. Firmly tighten all slip joint connections. Perform a water test on the entire installation by filling the tub with water up to the overflow opening and inspecting for any signs of leakage from underneath the tub. Let the water sit in the bathtub for a minimum of 30 minutes and inspect if leakage is occurring.

HOME SERVICES



INSTALLATION VIDEO

Missing Part or Defective?

Please Contact the Customer Service Team

 626-679-3588

 support@trendytotesinc.com