

abode

Compact Digital Microwave User Guide

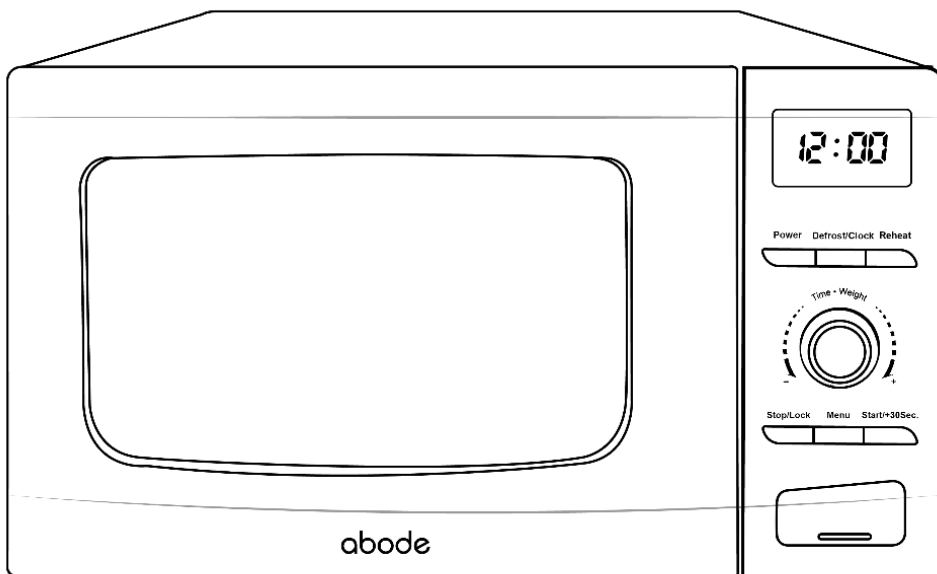

**Model Number:
AMD2002 (B-M) (S-M)**

**PLEASE RETAIN FOR FUTURE
REFERENCE**

CONTENTS

| | Page(s) |
|--------------------------------|----------------|
| Safety instructions | 3-9 |
| About your microwave | 10-11 |
| Product information | 12 |
| Unpacking the microwave | 13 |
| Product overview | 14 |
| Microwave oven installation | 15-16 |
| Turntable installation | 17-18 |
| Control panel | 19 |
| How to use the microwave | 20-25 |
| Cooking tips | 26 |
| Cleaning the microwave | 27 |
| Important utensil information | 28 |
| Problem solving | 29-32 |
| Guarantee & customer services | 33 |
| Spare parts | 34 |
| Connection to the mains supply | 35-36 |
| Notes | 37-39 |
| Disposal information | 40 |

SAFETY INSTRUCTIONS

IMPORTANT SAFETY INSTRUCTIONS READ CAREFULLY AND KEEP FOR FUTURE REFERENCE

WARNING:

- If the door or door seals are damaged, the oven must not be operated until it has been repaired by a competent person.
- It is hazardous for anyone other than a competent person to carry out any service or repair operation that involves the removal of a cover which gives protection against exposure to microwave energy.
- Liquids and other foods must not be heated in sealed containers since they are liable to explode.
- The appliance and its accessible parts may become hot during use. Care should be taken to avoid touching heating elements.
- Do not leave the microwave oven unattended while you are using it.
- Do not use the microwave when it is empty. This could damage the oven.
- This appliance is intended to be used in the household and general domestic applications. It is not intended to be used in industrial or commercial applications.

SAFETY INSTRUCTIONS

READ CAREFULLY AND KEEP FOR FUTURE REFERENCE

WARNING:

- This microwave is intended for heating food and beverages only. The drying of food or clothing and heating of warming pads, wheat bags, slippers, sponges, damp cloth and similar is extremely dangerous and may lead to risk of injury, ignition or fire.
- Do not use metal pans, dishes with metal handles or anything with a metal trim inside the microwave. Do not use paper covered wire twist-ties on plastic bags.
- Never put objects into the openings on the outer case.
- This appliance can be used by children aged from 8 years and above and persons with reduced physical, sensory or mental capabilities or lack of experience and knowledge, only if they are being supervised or have been given instruction in the safe use of the appliance and understand the hazards involved. Children should not play with the appliance.
- Food containing a mixture of fat and water (for example, stock) should stand for 30 to 60 seconds in the oven after it has been turned off. This is to allow the mixture to settle and to prevent it from bubbling when a spoon is placed in it, or a stock cube is added.

SAFETY INSTRUCTIONS

READ CAREFULLY AND KEEP FOR FUTURE REFERENCE

WARNING:

- When heating or cooking food or liquid, remember that there are certain foods (such as, jam, Christmas pudding, and mincemeat) which heat up very quickly.
- Microwave heating of beverages can result in delayed eruptive boiling, therefore care must be taken when handling the container.
- The contents of feeding bottles and baby food jars shall be stirred or shaken and the temperature checked before consumption, in order to avoid burns. Do not heat baby bottles with the teat left on. Remove it if replacing the bottle back into the oven.
- Eggs in their shell and whole hard-boiled eggs should not be heated in microwave ovens since they may explode, even after microwave heating has ended.
- Do not cook any food surrounded by a membrane, such as egg yolks, potatoes, chicken livers, sausages, ready meals and so on without piercing them several times with a fork.
- Do not try to deep-fry foods in this microwave oven.
- Do not overcook food.
- When heating food in plastic or paper containers, keep an eye on the oven due to the possibility of ignition.

SAFETY INSTRUCTIONS

READ CAREFULLY AND KEEP FOR FUTURE REFERENCE

WARNING:

- If materials inside the oven smoke or catch fire, keep the oven door closed to stifle the flames, turn the oven off at the wall switch, or shut the power off at the fuse or circuit-breaker panel. If smoke is emitted, switch off or unplug the appliance and keep the door closed in order to stifle any flames.
- Please remember that as food or liquids heat up, they will release steam or may be spitting. Never cover any container fully, always leave a gap for steam to escape.
- Do not use plastic containers when heating or cooking foods that contain a lot of fat or sugar.
- Always have the glass turntable and turntable support in place when using the microwave oven.
- Do not cook food directly on the glass turntable. Put food on a suitable plate or in a bowl before putting it in the oven.
- When using the grill rack and baking tray, be aware that these will become HOT during cooking as they aren't heatproof. Please use suitable oven gloves when removing these.

SAFETY INSTRUCTIONS

READ CAREFULLY AND KEEP FOR FUTURE REFERENCE

WARNING:

- Do not use melamine dishes as they contain a material which will absorb microwave energy. This may cause the dishes to crack or burn, and will slow down the cooking speed.
- Use only cookware and utensils that are approved for use in a microwave oven.
- Do not use the microwave oven for heating utensils, plates or dishes.
- Do not cook using a container with a restricted opening, such as bottles, as they may explode.
- Before you clean your microwave oven, turn it off and unplug it.
- Keep the inside of the oven clean. When food or liquids stick to the oven walls, wipe with a damp cloth. We recommend that you do not use harsh detergent or abrasives.

SAFETY INSTRUCTIONS

READ CAREFULLY AND KEEP FOR FUTURE REFERENCE

WARNING:

- On the right hand wall of the cavity is the waveguide cover, microwaves are passed through this to enable your food to cook. It is important that this waveguide cover is kept clean at all times. To do this wipe with mild detergent and water, then dry.
- The oven should be cleaned regularly and any food deposits removed. Failure to maintain the oven in a clean condition could lead to deterioration of the surface that could adversely affect the life of the appliance and possibly result in a hazardous situation.
- You should clean the outside of the oven with a damp cloth. Do not allow water to seep into the ventilation openings.
- Do not use harsh abrasive cleaners or sharp metal scrapers to clean the oven door glass since they can scratch the surface, which may result in shattering of the glass.
- If steam builds up inside or around the outside of the oven door, wipe with a soft cloth. This may happen when the microwave oven is used in humid conditions.

SAFETY INSTRUCTIONS

READ CAREFULLY AND KEEP FOR FUTURE REFERENCE

WARNING:

- Regularly remove the glass turntable to clean it, wash it in warm soapy water or a dishwasher. Regularly clean the turntable support and oven floor. Simply wipe the bottom surface of the oven with mild detergent and water, then dry. You can wash the turntable support in mild soapy water.
- Failure to maintain the oven in a clean condition, especially if liquid is left under the turntable, could lead to deterioration of the surface that will adversely affect the life of the appliance that may result in a hazardous condition.

ABOUT YOUR MICROWAVE

Thank you for purchasing your Abode microwave oven.

Designed with style and practicality in mind, this 20L digital microwave boasts impressive functionality, with a range of programmes to help make mealtimes easier.

With a dial and button control panel, this appliance is sleek, stylish and easy to use. Offering 700 watts of microwave power, there are 5 power levels to choose from, providing you with quick and convenient cooking in your home. Plus, there's plenty of space for a round dinner plate up to 11".

The AMD2002 boasts added features to enhance your cooking experience. As well as simple microwaving, you can choose from 8 pre-set cooking menus that make your life easier. Cook anything from popcorn to pizza, jacket potatoes and even fish.

Cooking your favourite meals should be simple. For added functionality, there's also a defrost setting, saving you time so that you can heat meals straight from the freezer. Simply input the weight of the food you need defrosting or the time you would like to defrost the food for and go! Cooking has never been so easy.

Cleaning is straight forward, simply wipe the exterior, interior and waveguide cover with a damp soft cloth to maintain peak performance.

In the unlikely event that you experience any issues with your product, please make our friendly Customer Service team your first point of call.

ABOUT YOUR MICROWAVE

How do microwaves work?

Microwaves are high-frequency electromagnetic waves similar to radio waves. While radio waves may vary in length from one metre to many kilometres, microwaves are very short (less than 12.5 centimetres).

Microwaves do not make any heat themselves but cause water molecules in food to vibrate.

This vibration produces heat that cooks the food. This is why your food will come out of the microwave piping hot, when your utensils inside the oven stay much cooler. The microwaves do not stay in the air or in the food when you open the microwave oven door.

The microwave oven will work using an ordinary household electrical socket. Inside the microwave oven is the magnetron, which turns the electrical energy into microwaves.

Microwaves cannot travel through metal, so the inside of the oven is lined with metal. The door is lined with a fine metal mesh which stops microwaves getting through. This means that when the microwave oven door is shut, there is no possibility that microwaves can be released.

PRODUCT INFORMATION

| | |
|---------------------------------------|---------------|
| Rated Voltage | 220-240V/50Hz |
| Rated Output Power (Microwave) | 700W |
| Oven Capacity (litres) | 20* |

*Internal volume is calculated by measuring maximum width, depth and height. Actual capacity for holding food is less.

UNPACKING THE MICROWAVE

Before you use your microwave oven

1. Remove all the packaging. **Do not** remove the large piece of plastic from the right hand side of the cavity wall (Refer to the below image). This is called a waveguide cover and allows the microwaves to pass through to cook the food.

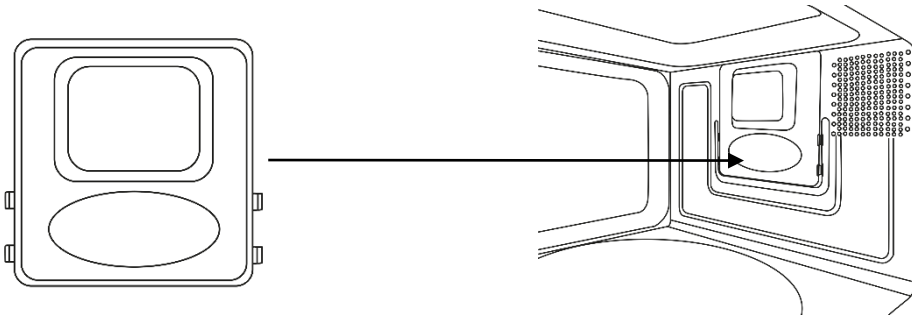

Please ensure you keep this cover clean at all times by wiping with a damp cloth. Do not remove/place in a dishwasher.

2. Check the oven after unpacking for any visual damage such as:

- A misaligned door
- Damage to the door
- Dents or holes in the door window and screen
- Dents in the inside

If you can see any damage **do not use the oven**, please call **0345 209 7461**.

This microwave oven weighs approximately 10.7Kg so you must put it on a horizontal surface that is strong enough to support this weight.

The oven must be placed away from high temperatures and steam.

Do not put anything on the top of the microwave oven.

PRODUCT OVERVIEW

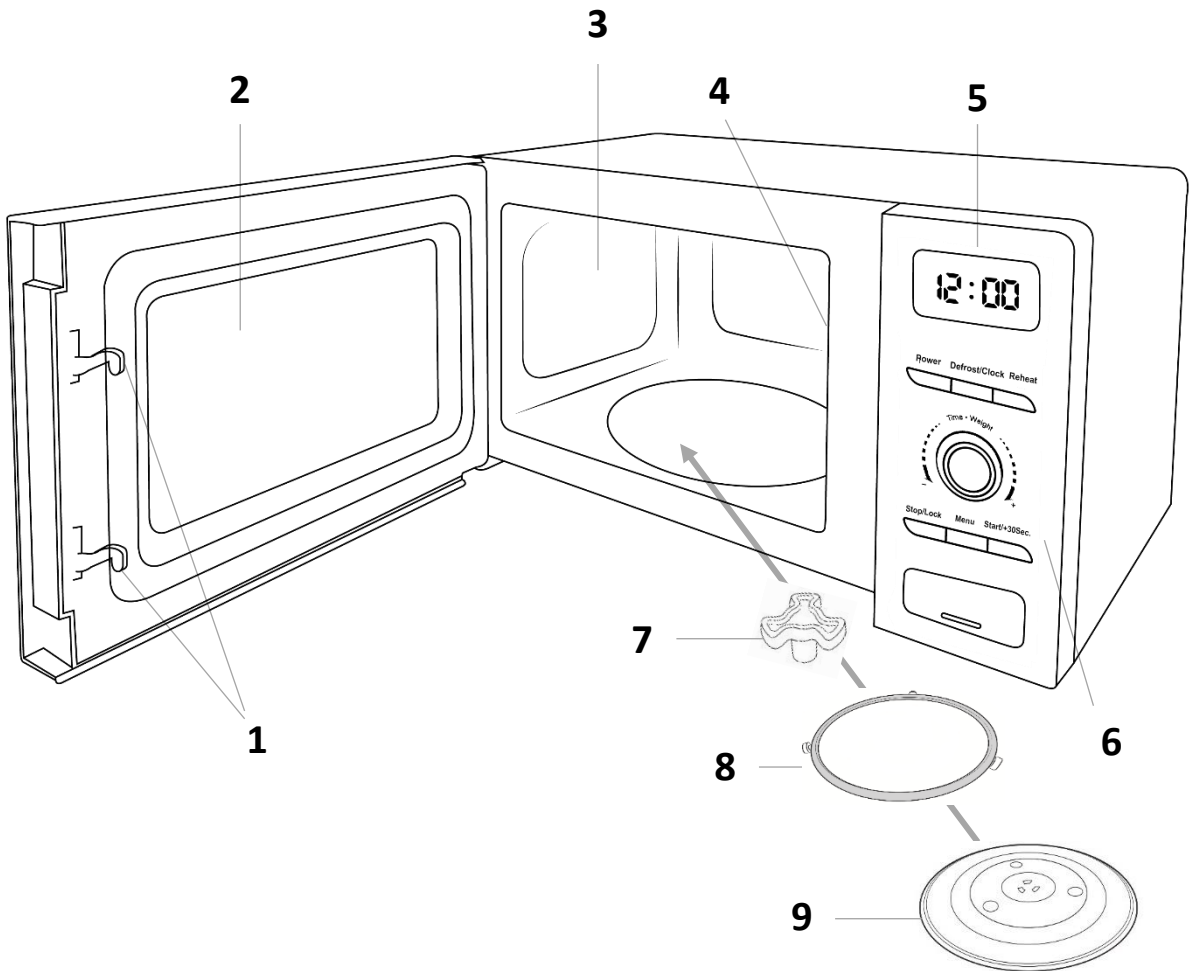

- | | |
|------------------------------------|-----------------------|
| 1. Safety interlock latches | 5. Screen display |
| 2. Door assembly and window | 6. Control panel |
| 3. Oven cavity | 7. Turntable coupling |
| 4. Waveguide cover (do not remove) | 8. Roller ring |
| | 9. Glass turntable |

MICROWAVE OVEN INSTALLATION

- Place the oven as far away from radios and televisions as possible. Using the oven may cause interference with the reception.
- Plug the oven into a suitable 13 amp mains socket, make sure the voltage is the same as on the rating label (do not use extension cables or mains socket adaptors).

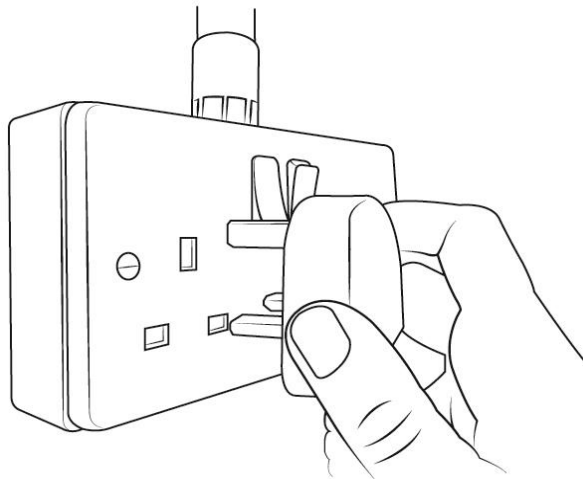

- The microwave oven should be used freestanding only and must not be built-in or used in a cabinet.
- Select a level surface that provides enough space for the outlet vents.

MICROWAVE OVEN INSTALLATION

The minimum installation height is 85cm.

A minimum clearance of 10cm is required between the back of the microwave oven and the wall, and 5cm between the sides of the microwave oven and any adjacent walls. Leave a minimum clearance of 20cm above the oven.

WARNING:

DO NOT install the oven over a cooker or other heat or steam producing appliance as this will damage the microwave oven.

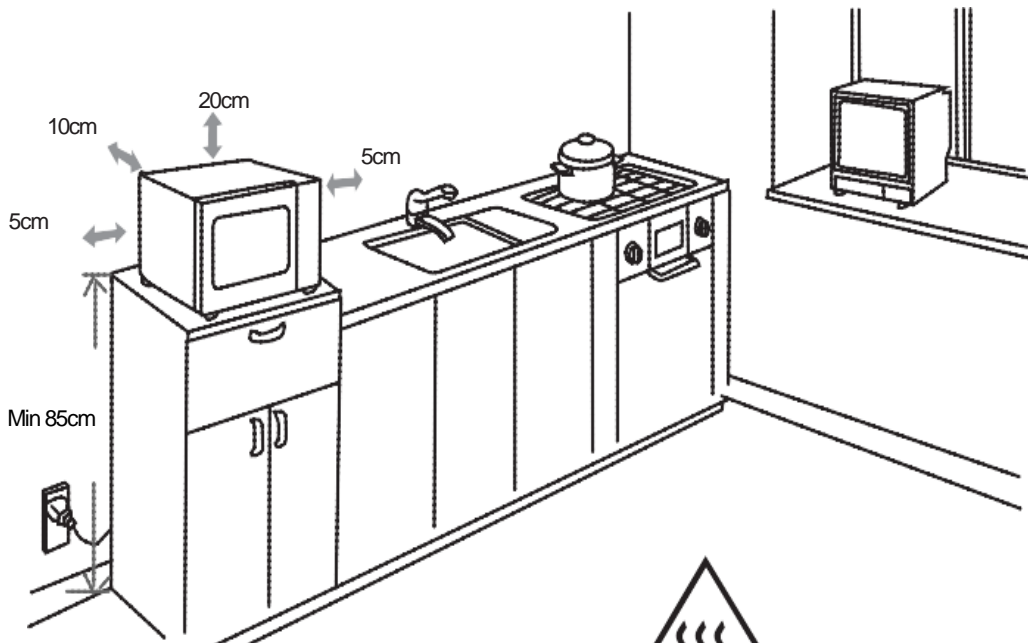

DO NOT obstruct
the ventilation
from the microwave



This symbol
means:
Hot Surfaces

TURNTABLE INSTALLATION

- Before first use, check that any securing tape and all packaging has been removed from the glass turntable and turntable ring assembly.
- **These parts must never be restricted from rotating.**
- Never place the glass turntable upside down.
- To assemble the turntable, follow the steps below in number order.

STEP 1) The turntable coupling should slot into the centre of microwave

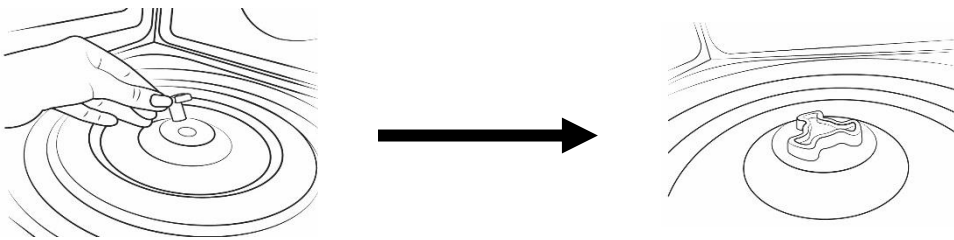

STEP 2) The turntable ring slots into the indents in the middle

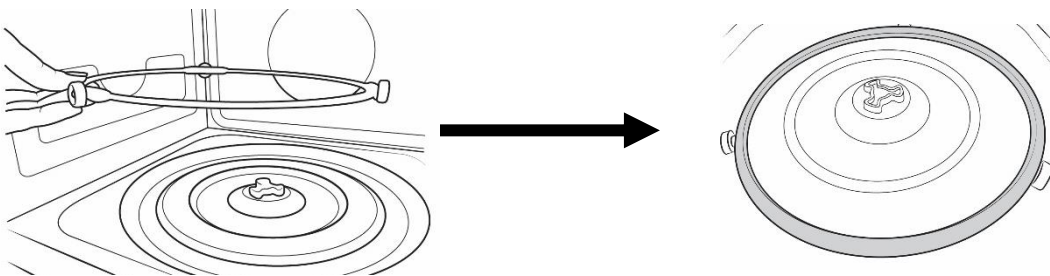

STEP 3) The glass turntable should align with the turntable coupling

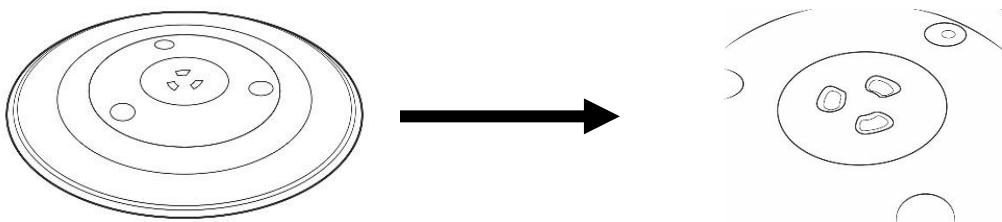

TURNTABLE INSTALLATION

The glass turntable, turntable ring, and turntable coupling assembly must always be used during cooking (as shown below).

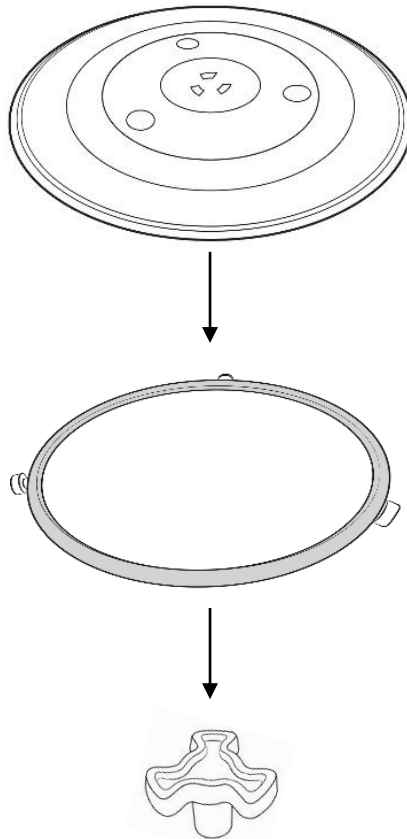

- Do not place the food directly onto the glass turntable, always place on or in suitable microwaveable cookware.

Please check that crockery is microwave safe before using.

- If the glass turntable or turntable ring assembly has been damaged in any way, please call our Customer Service team on **0345 209 7461**.

CONTROL PANEL

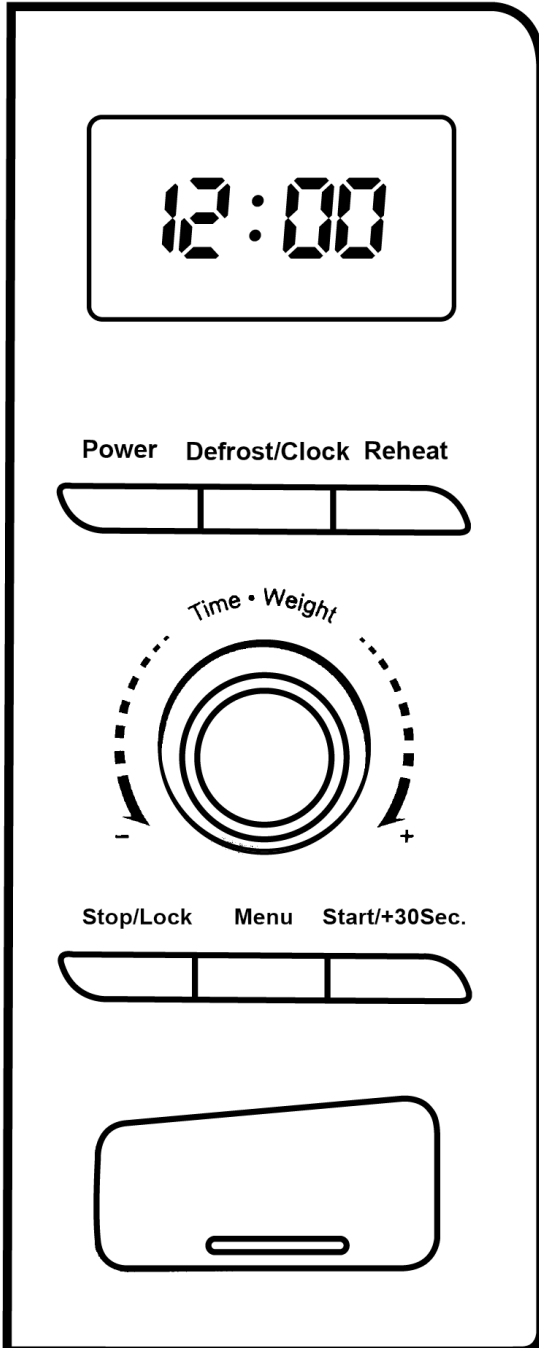

Screen Display

Cooking time, power, action indicators, and clock time are displayed.

Power

Press to select the desired microwave power.

Defrost/Clock

Press and then input weight or time for defrosting, or hold down this button to set the clock.

Time/Weight Dial

Turn this to change the time and weight.

Reheat

Press and then input weight for reheating the food.

Stop/Lock

Press to stop the cooking process, or hold down for 3 seconds to set the child lock.

Menu

Press to select the kind of food you want to cook from the 8 auto menus.

START/+30Sec.

Press to start a cooking programme and simply press it a number of times to set a quick start cooking time.

Opening Button

Press to open the door of the appliance.

HOW TO USE THE MICROWAVE

Turn on the power

Connect the main plug into a suitable 13amp mains socket.

Note: Make sure the voltage is the same as on the rating label located on the back of the microwave (do not use extension cables or mains socket adaptors).

The microwave oven will flash and beep once.

Setting the clock (24 hour)

This microwave only displays the time in 24 hour format. To set the time:

1. Press and hold down the **'Defrost/Clock'** button for more than 3 seconds. The hour position will flash.
2. Turn the dial to select the hours digit, and then press the **'Defrost/Clock'** button to confirm. The minute position will now flash.
3. Turn the dial to select the minutes digit, and then press the **'Defrost/Clock'** button to confirm.
4. The clock is now set.

Note:

Before setting a cooking programme the clock needs to be set.

If the clock is not set, the clock will not function when powered.

During the process of clock setting, if you press the **'Stop/Lock'** button, the oven will go back to its resting state.

Microwave cooking

Once you have correctly installed the unit, turned on the power and set the clock, you are ready to start cooking.

Your microwave has 5 power levels, the lowest 10%, and then 30%, 50%, 80%, and 100% (full power).

Most recipes are cooked on full power – this should be indicated on the packaging of microwavable food.

HOW TO USE THE MICROWAVE

1. To select a power level, press the '**Power**' button.

- When pressed once the screen display will show 100%
- When pressed twice the screen display will show 80%
- When pressed three times the screen display will show 50%
- When pressed four times the screen display will show 30%
- When pressed five times the screen display will show 10%

2. Then turn the dial to select the required time.

3. Press the '**Start/+30 Sec.**' button to commence cooking.

4. Once cooking is complete, the display will show 'End' and 3 beeps will sound. These will repeat every few minutes until the microwave door is opened or the '**Stop/Lock**' button is pressed.

Please note: The maximum time that can be entered is 1 hour (60:00). Do not operate the microwave empty, this can cause irreparable damage. At the maximum microwave power, the oven will automatically lower the power after a certain length of cooking time in order to lengthen the service life of the appliance.

Please note: During the process of setting the cooking programme, if you press the '**Stop/Lock**' button, the oven will go back to its resting state.

Pausing cooking

If you want to pause the cooking to turn over or stir contents, simply open the door, then close again and press the '**Start/+30 Sec.**' button to continue the cycle.

If you wish to stop cooking with time left on the display, take out the contents, close the door and press the '**Stop/Lock**' button once to clear.

HOW TO USE THE MICROWAVE

Quick start function

For quick and easy microwave cooking, you can press the **'Start/+30 Sec.'** button to automatically add 30 seconds of cooking time. This can be pressed multiple times for cooking up to 60 minutes on full power.

Note: This function does not work for defrost or auto menu.

Defrost

The microwave generally penetrates 4cm into most foods. Therefore you must ensure food is thoroughly defrosted before starting the cooking process.

For even defrosting results, ensure you turn the food over during the cycle.

Defrosting generally takes longer than the cooking time of food.

Defrosted food should be consumed as soon as possible; do not put it back in the fridge or freeze again.

This microwave has two defrost modes:

dEF1 – For defrosting food by weight, with a weight range of 100g to 1500g.

dEF2 – For defrosting food by time, with a maximum time of 60 minutes.

As an example, to defrost 400g of poultry:

1. Press the **'Defrost/Clock'** button and **'dEF1'** will be displayed.
2. Turn the dial clockwise until the display shows **'400g'**.
3. To commence defrosting, press the **'Start/+30 Sec.'** button.

As an example, to defrost food for 25 minutes:

1. Press the **'Defrost/Clock'** button twice and **'dEF2'** will be displayed.
2. Turn the dial clockwise until the display shows **'25:00'**.
3. To commence defrosting, press the **'Start/+30 Sec.'** button.

HOW TO USE THE MICROWAVE

On both defrost programmes approximately two thirds of the way through the defrosting time, the microwave will beep and pause. This is to allow you to turn over the food for even defrosting. Turn over or rearrange the food and press the **'Start/+30 Sec.'** button to resume defrosting. To defrost fatty meat, defrost intermittently until defrosted. Ice should be removed at all times.

Once defrosting is complete, the display will show 'End' and 3 beeps will sound. These will repeat every few minutes until the microwave door is opened or the **'Stop/Lock'** button is pressed.

Please note: During the process of setting the cooking programme, if you press the **'Stop/Lock'** button, the oven will go back to its resting state.

Please note: Ensure food is thoroughly defrosted before starting the cooking process

Reheat

The reheat function is there to help you reheat food according to its weight.

1. Press the **'Reheat'** button once and **'200g'** will be displayed.
 - Press the **'Reheat'** button twice and **'400g'** will be displayed.
 - Press the **'Reheat'** button three times and **'600g'** will be displayed.
 - Press the **'Reheat'** button four times and **'800g'** will be displayed.
 - Press the **'Reheat'** button five times and **'1000g'** will be displayed.
2. Once the correct weight is displayed, press the **'Start/+30 Sec.'** button to start.
3. Once cooking is complete, the display will show 'End' and 3 beeps will sound. These will repeat every few minutes until the microwave door is opened or the **'Stop/Lock'** button is pressed.

HOW TO USE THE MICROWAVE

Child lock

The lock prevents unsupervised operation by children.

To set: In standby mode, press and hold the '**Stop/Lock**' button for 3 seconds. A beep will sound, the oven will auto enter child lock mode, and the lock indicator light will turn on. In the locked state, all buttons are disabled.

To cancel: Press and hold the '**Stop/Lock**' button for 3 seconds. A beep will sound and the lock indicator light will turn off.

Auto cook menu

There are 8 auto menus you can use for easy cooking. They automatically calculate the cooking time based on the type of food and its weight. For guide lines, please see the Auto menu table on the following page.

1. Place the food in a container suitable for use with microwave ovens and put it into the oven.
2. Press the '**Menu**' button several times until you have selected a menu suitable for the type of food you want to cook. Use the table on the next page as a guide.
3. Turn the dial to select from the weight options on the display.
4. Keep turning the dial until you reach the required weight.
5. Press the '**Start/+30 Sec.**' button. The microwave will now start to cook the food.
6. Once cooking is complete, the display will show 'End' and 3 beeps will sound. These will repeat every few minutes until the microwave door is opened or the '**Stop/Lock**' button is pressed.

Please note: It is advisable to stir and turn food where needed to ensure even cooking. Be sure to handle hot food with care.

Please note: During the process of setting the cooking programme, if you press the '**Stop/Lock**' button, the oven will go back to its resting state.

HOW TO USE THE MICROWAVE

You will need to use your discretion regarding food type, temperature and weight as times may vary – the table on the below is a guideline for each auto cooking setting:

| Auto Menu | Display | Weights | Recommendations |
|------------------|---------|---|---|
| Jacket Potato | A.1 | 250g 500g 750g | Pierce the skin of the potato, place onto a microwave safe plate and cover with a lid or cling film. |
| Pasta | A.2 | 50g 100g 150g | Place the pasta into a suitable container, cover with boiling water. |
| Pizza | A.3 | 200g 400g | Place onto a microwave safe plate and cover with cling film. |
| Popcorn | A.4 | 100g | Add the popcorn kernels to a medium to large microwave safe glass bowl and cover with a lid or microwave safe plate. |
| Fresh Vegetables | A.5 | 200g 400g 600g | Place vegetables into a microwave-safe dish. Add 1-2 tablespoons of water (a little more if you're steaming multiple portions). Place in the microwave and pop a lid on top to keep the steam in. |
| Beverage | A.6 | 1 cup - 250ml 2 cups - 500ml 3 cups - 750ml | Place the cup onto the center of the turntable. When the liquid has been removed from the oven, leave to stand before adding sugar. |
| Meat | A.7 | 200g 400g 600g | Place the food in a suitable container and cover with microwave safe cling film. The oven will pause and beep in the middle of cooking time to remind the user to turn over food for uniform cooking. |
| Fresh Fish | A.8 | 200g 400g 600g | Place the food in a suitable container and cover with microwave safe cling film. The oven will pause and beep in the middle of cooking time to remind the user to turn over food for uniform cooking. |

COOKING TIPS

Defrosting tips

Microwaves penetrate around 4cm into most food. To maximize defrosting effectiveness follow the below guidelines:

1. For thick foods, turn regularly during operation in order to defrost evenly.
2. If food weighs over 500g, it is advised to turn at least 2 times.
3. Defrosted food should be consumed as soon as possible, it is not advisable to put back into the fridge or freeze again.

Cooking tips - The following may affect cooking results:

Food arrangement

If possible, thicker bits of food should be placed around the outside of the dish and the thinner parts toward the centre, spread out as evenly as possible. Do not overlap food if possible as this could result in uneven cooking results.

Cooking length

If you are unsure of cooking times it is advisable to start with a short cooking time and monitor cooking progress before adding further time. Overcooking could lead to a risk of fire. Ensure food is cooked thoroughly before consuming.

Cooking food evenly

Foods such as meat should be turned frequently to ensure more even cooking results. If the food is liquid based, stirring during the cooking time is advisable.

Allow standing time

When the microwave has stopped cooking, leave the food to rest for an adequate length of time to allow for cooking completion and cooling.

CLEANING THE MICROWAVE

- Before you clean the oven, **turn it off and unplug it.**
- Keep the inside of the oven clean. When food or liquids stick to the oven walls, wipe with a damp cloth. We recommend that you do not use harsh detergent or abrasives.
- On the right hand side wall of the cavity is the waveguide cover, microwaves are passed through this to enable your food to cook. It is important that this waveguide cover is kept clean at all times. To do this wipe with mild detergent and water, then dry.
- You should clean the outside of the oven with a damp cloth. **Do not allow water to seep into the ventilation openings.**
- **Do not allow the control panel to become wet.** Clean with a soft, damp cloth. Do not use detergents, abrasives or spray-on cleaners on the control panel.
- If steam builds up inside or around the outside of the oven door, wipe with a soft cloth. This may happen when the microwave oven is used in humid conditions.
- Regularly remove the glass turntable to clean it, and wash it in warm soapy water. Regularly clean the turntable support and oven floor. Simply wipe the bottom surface of the oven with mild detergent and water, then dry. You can wash the turntable support in mild soapy water.
- When removing the turntable support of the oven, make sure you put it back properly.
- If the inside of the oven smells, put a cup of water with the juice and skin of one lemon in a deep microwave bowl. Microwave it for three minutes, wipe thoroughly and then dry with a soft cloth.

IMPORTANT UTENSIL INFORMATION

- Do not use metal pans or dishes with metal handles.
- Do not use anything with a metal trim.
- Do not use paper covered wire twist-ties on plastic bags.
- Do not use melamine dishes as they contain a material which will absorb microwave energy. This may cause the dishes to crack or burn, and will slow down the cooking speed.
- Use only cookware that is approved to be used in a microwave oven.
- Do not cook using a container with a restricted opening, such as bottles, as they may explode.
- Do not heat baby bottles with the teat left on. Remove it if replacing the bottle back into the oven.
- Only use thermometers that are approved for microwave ovens.
- Do not use the microwave oven for heating utensils.

PROBLEM SOLVING



WARNING: To reduce the risk of personal injury, always unplug the microwave before performing maintenance or trouble shooting checks.

The microwave oven may cause interference to your radio, TV or similar equipment. If this happens, you can stop the interference by moving the radio, TV or equipment as far away from your microwave oven as possible.

| Problem | Potential reason | Potential solution |
|--------------------------------------|---|---|
| If the microwave doesn't work | 1. Microwave is not plugged in | Make sure the plug is plugged in securely into the mains and the plug is switched on. If it is not, remove the plug from the socket, wait 10 seconds and plug it in again securely. |
| | 2. Plug is not working | The plug socket that the microwave is plugged into may have become faulty. Plug the microwave into another known good plug socket, ensure that the socket is turned on and check if the microwave now works. |
| | 3. The plug has a blown fuse or the mains circuit has a blown fuse/tripped fuse | Check the plug for a blown circuit fuse or a tripped main circuit breaker. If these seem to be working properly, test the socket with another appliance. |
| | 4. Microwave has developed a fault | Contact customer services to talk through the problem to see if any solution for the fault can be found. If not and the product is within its warranty period, then the microwave should be returned to the retailer it was purchased from for a replacement or refund. |
| If the microwave power will not work | 1. Door is not closed | Make sure the door is securely closed. Otherwise, the microwave will not engage or operate. |
| | 2. The power has not been set/the timer dial has not been turned. | Set the microwave power by pressing the 'Power' button. Select the time by turning the dial and pressing 'Start' to confirm. |
| Not heating | Magnetron not working | The component that produces the microwaves is called a magnetron, if food is not being heated or is 'luke' warm then it is likely this component has developed a fault. If the microwave is within its warranty period, please contact customer services for further advice or take the microwave back to the retailer it was purchased from for a refund or replacement. |

PROBLEM SOLVING

| Problem | Potential reason | Potential solution |
|------------|------------------------------------|---|
| Sparking | 1. Burnt on food debris | Spillages or splashes can burn and catch fire, all food that is put into the microwave should be appropriately covered. All spillages or splashes must be cleaned, and all areas of microwave cleaned after each use. Burnt on food debris in the microwave, on the waveguide and behind the waveguide can cause the microwave to 'spark'. This is because burnt on debris can be focused on by the microwaves and spark. Microwaves must be thoroughly cleaned after every use to ensure no food is burnt on to any part of the microwave. If the microwave does 'spark' the waveguide must be disposed, the microwave <u>must</u> be cleaned thoroughly and then contact customer services for a replacement waveguide. The replacement waveguide should be fitted and the microwave should operate normally. However, if the microwave 'sparks' again on first use (after the waveguide has been replaced and the microwave cleaned,) please contact customer services for further advice. |
| | 2. Metal or foil | No metal or foil should be put inside a microwave as it can cause 'sparking' which can damage the microwave. The only metal accessories that should be used inside the microwave are the ones supplied by the manufacturer. |
| | 3. Pressure build up in food | Food with none porous skins (potatoes for example), must be pierced to allow steam to escape. The build up of pressure can cause food to burst and create a 'fire hazard'. |
| Heat spots | Operated empty or with no moisture | Microwaves cannot be run empty, microwaves need moisture to operate correctly. If microwaves are operated empty or are used to heat up plates (this is not permitted), the microwaves can focus on a single point inside the microwave. This can cause a heat spot, which can cause the area to become deformed, warped or start to melt. If microwaves are operated empty or to heat up foreign objects this will void the warranty. |

PROBLEM SOLVING

| Problem | Potential reason | Potential solution |
|------------------------------|--|--|
| Condensation or excess water | 1. Food that is being cooked | By the very nature of how a microwave works, it 'excites' the water molecules in the food it is heating, causing them to move about and generate heat from within the food. Often when the food heats up it reaches the point where steam is released. Dependant on the food type being heated (and its water content level), the length of time being heated for – and so the amount of steam generated – it is inevitable that some of the steam will condense and form back into water droplets within the microwave cavity. This can usually be found on the inner walls or most commonly on the back of the glass door. If not cleaned up, these droplets can start to form small 'pools' of water. |
| | 2. Cooling vents covered | Cooling vents allow the heat and steam to escape from the microwave. These cannot be covered as it can cause excessive water to settle inside the microwave or the microwave to overheat. The installation instructions in the instruction manual must be followed or the warranty will be void. |
| Paint damage/peeling | Maintenance | If the microwave is within its warranty period, please contact customer services for further advice or take the microwave back to the retailer it was purchased from for a refund or replacement. |
| Light not working | Bulb not working | Due to the construction of microwaves and certain 'dangerous' components inside, the light bulb can only be changed by a qualified service engineer. If the microwave is within its warranty period, please contact customer services for further advice or take the microwave back to the retailer it was purchased from for a refund or replacement. |
| Over heating | Cooling vents covered | Cooling vents allow the heat and steam to escape from the microwave. These cannot be covered as it can cause excessive water to settle inside the microwave or the microwave to overheat. The installation instructions in the manual must be followed or the warranty will be void. |
| Too noisy | 1. Glass turntable fitted incorrectly | Check that the glass turntable has been placed correctly on the turntable and is not hitting the walls/doors of the microwave during operation. |
| | 2. Dishes/plates are too large for the microwave | Check that the dishes/plates are the correct size for the microwave and that they are not hitting the walls/door of microwave during operation. |

PROBLEM SOLVING

| Problem | Potential reason | Potential solution |
|-------------------------------|---|---|
| Door not shutting/ locking | 1. Glass turntable fitted incorrectly | Check that the glass turntable has been placed correctly on the turntable and is not stopping the door from shutting correctly. |
| | 2. Latches have become deformed | If the microwave is within its warranty period, please contact customer services for further advice or take the microwave back to the retailer it was purchased from for a refund or replacement. |
| Turntable not rotating | 1. Turntable coupling not fitted or tape not removed | Check that the turntable coupling is fitted correctly and the transportation tape has been removed. |
| | 2. Turntable roller ring not fitted or fitted incorrectly | Check that the coupling has been placed under the turntable and that it is positioned correctly. |
| | 3. Glass turntable fitted incorrectly | Check that the glass turntable has been placed correctly on the turntable. |
| | 4. Turntable has developed a fault | If the microwave is within its warranty period, please contact customer services for further advice or take the microwave back to the retailer it was purchased from for a refund or replacement. |

GUARANTEE AND CUSTOMER SERVICES

This product is guaranteed for **12 months** from the date of the original purchase. If any defect arises due to faulty materials or workmanship, the faulty product must be returned to the place of purchase. Refund or replacement is at the discretion of the retailer.

The following conditions apply:

- The product must be returned to the retailer with the original proof of purchase.
- The product must be installed and used in accordance with the instructions contained in this instruction guide and any other instructions for use which are supplied.
- It must be used for domestic purposes only and for its intended use.
- This warranty does not cover wear and tear, damage, misuse or consumable parts.

This does not affect your statutory rights.

Customer Services & Spare Parts:

| Region | Contact |
|-----------------------|-----------------------------|
| UK & Northern Ireland | 0345 209 7461 |
| Ireland | 1 800 938982 |
| Rest of Europe | europa@productcaregroup.com |

SPARE PARTS

To check the availability of the following spare parts, simply contact our friendly Customer Service team on **0345 209 7461**.

Turntable coupling

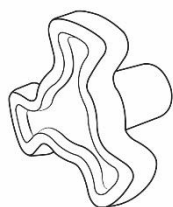

Turntable ring

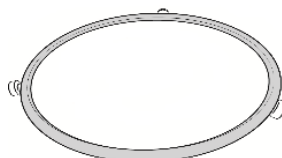

Glass turntable

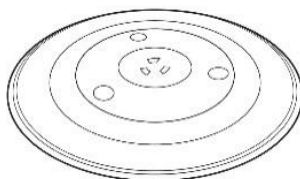

CONNECTION TO THE MAINS SUPPLY

WARNING- THIS APPLIANCE MUST BE EARTHED

This appliance is designed to operate from a mains supply of
220-240V~ 50Hz.

Check that the voltage marked on the product corresponds with
your supply voltage.

This product is fitted with a 13A plug complying with BS1363.
If this plug is unsuitable or needs to be replaced, refer to customer
services.

Important: The wires in the mains lead are coloured in
accordance with the following code:

GREEN/YELLOW – EARTH

BLUE - NEUTRAL

BROWN – LIVE

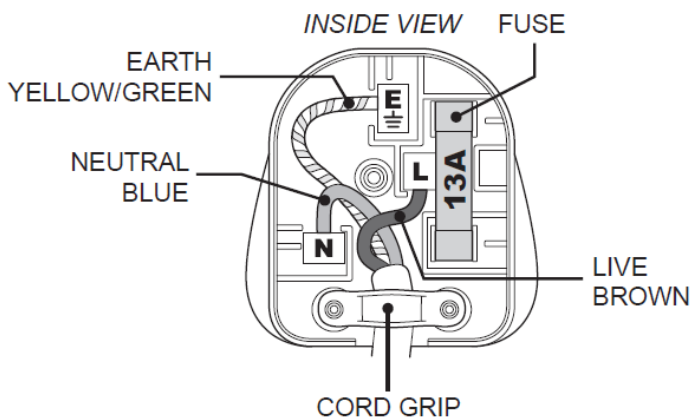

CONNECTION TO THE MAINS SUPPLY

For UK use only – PLUG

As the colours of the wires in the mains lead of this appliance may not correspond with the coloured markings identifying the terminals in your plug, proceed as follows:

- The **GREEN/YELLOW** wire is the EARTH and must be connected to the terminal which is marked with the letter E or by the earth symbol or coloured **GREEN** or **GREEN/YELLOW**.
- The **BLUE** wire is the NEUTRAL and must be connected to the terminal marked with the letter N or coloured **BLACK**.
- The **BROWN** wire is the LIVE wire and must be connected to the terminal marked with the letter L or coloured **RED**.
- **Always ensure that the plug cord grip is fastened correctly.**
- If a 13A (BS1363) fused plug is used it must be fitted with a 13amp fuse conforming to BS1362 and be BSI or ASTA approved.

If the fuse cover is lost the plug must not be used until a replacement is obtained from an electrical supplier.

If you need to remove the plug, cut it from the mains lead and dispose of it. NEVER attempt to re-use this plug or insert it into a socket outlet, as there is a very great risk of electrical shock.

NOTES

A large, empty rounded rectangular box with a thin black border, intended for writing notes. The box is centered on the page and occupies most of the vertical space below the title and above the footer.

NOTES

A large, empty rounded rectangular box with a thin black border, intended for writing notes. The box is centered on the page and occupies most of the vertical space below the title and above the footer.

NOTES

A large, empty rounded rectangular box with a thin black border, intended for writing notes. The box is centered on the page and occupies most of the vertical space below the header and above the footer.

abode

Made by Product Care Trading Limited. Product Care Trading Ltd, Unit 1, Green Bank Business Park, Swan Lane, Hindley Green, Wigan, WN2 4AY, United Kingdom / Product Care (Ireland) Ltd, Unit 3D North Point House, North Point Business Park, New Mallow Road, Cork, T23 AT2P, Ireland.

UK
CA

C

E

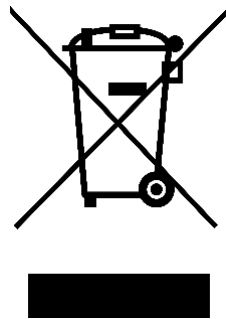

The 'wheeie bin' symbol is known as the 'Crossed-out wheeie bin Symbol'. When this symbol is marked on a product/batteries, it means that the product/batteries should not be disposed of with your general household waste. Only discard electrical/electronic/battery items in separate collection schemes, which cater for the recovery and recycling of materials contained within. Your co-operation is vital to ensure the success of these schemes and for the protection of the environment. For your nearest disposal facility, visit www.recycleyourelectricals.org.uk or ask in store for details.

SEDEX – Connecting businesses and their global suppliers to share ethical data and enabling improvement in ethical performance. Visit www.sedex.org.uk for further information.

We reserve the right, due to possible changes to design, to alter the instruction manual without prior notice.