

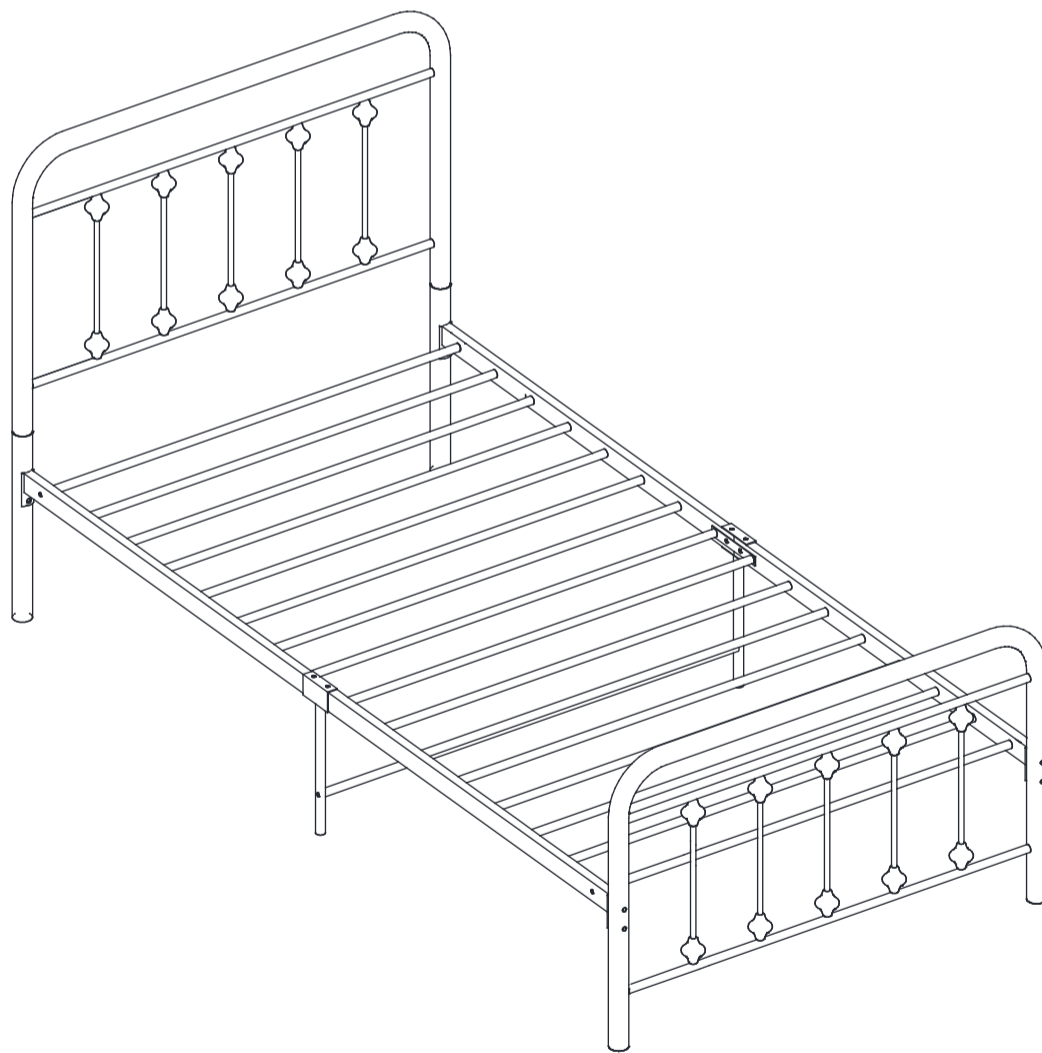

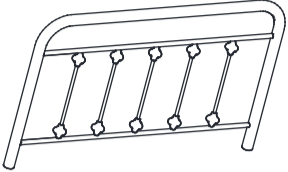







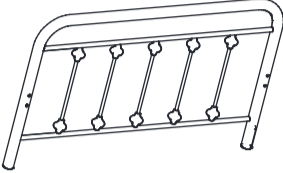

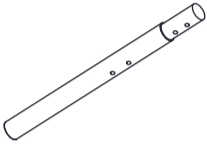

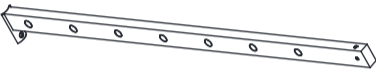

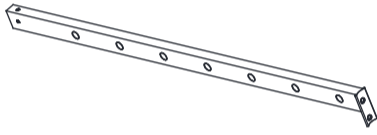

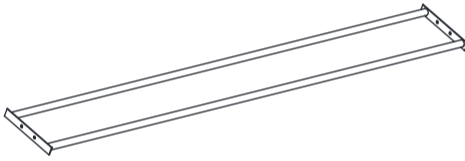

ASSEMBLY INSTRUCTION



PARTS AND HARDWARE LIST

A		1PC	N	 M6*25mm	4PCS
B		1PC	O	 M6*12mm	8PCS
C		2PCS	P	 M8	4PCS
D		2PCS	Q	 M6	4PCS
E		2PCS	R		8PCS
F		1PC	S	 M8	1PC
G		2PCS	T	 M6	1PC
H		12PCS	U		1PC
I		1PC			
J		2PCS			
K	 M8*45mm	8PCS			
L	 M6*50mm	4PCS			
M	 M6*45mm	2PCS			

STEP 1

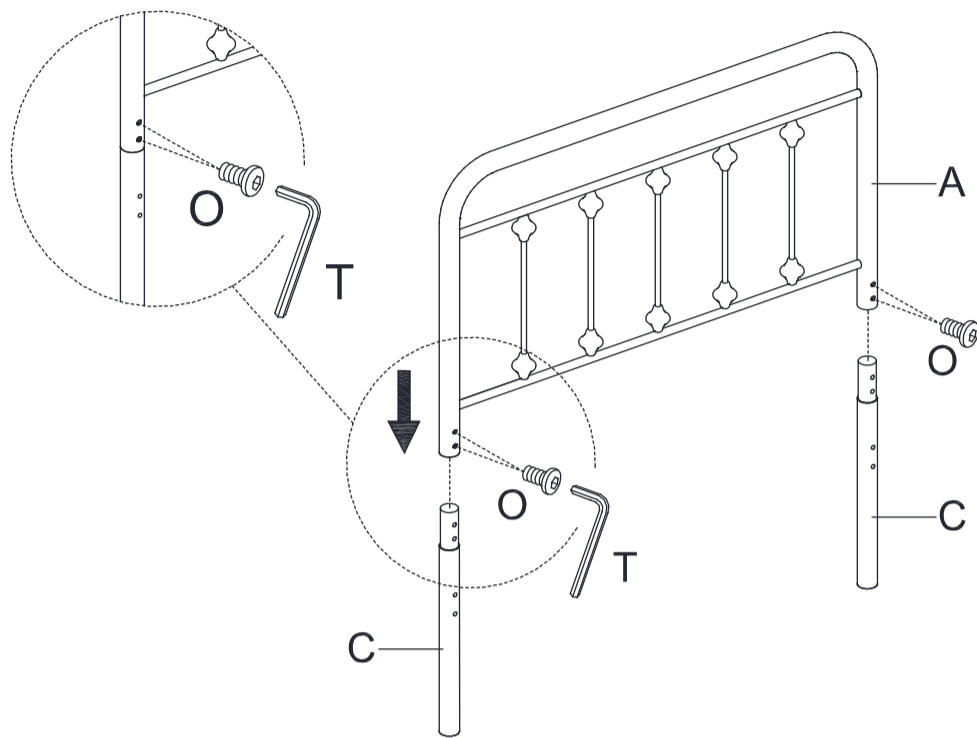

Attach A*1 to C*2 with bolts O*4, and then tighten them with Allen Key T.

STEP 2

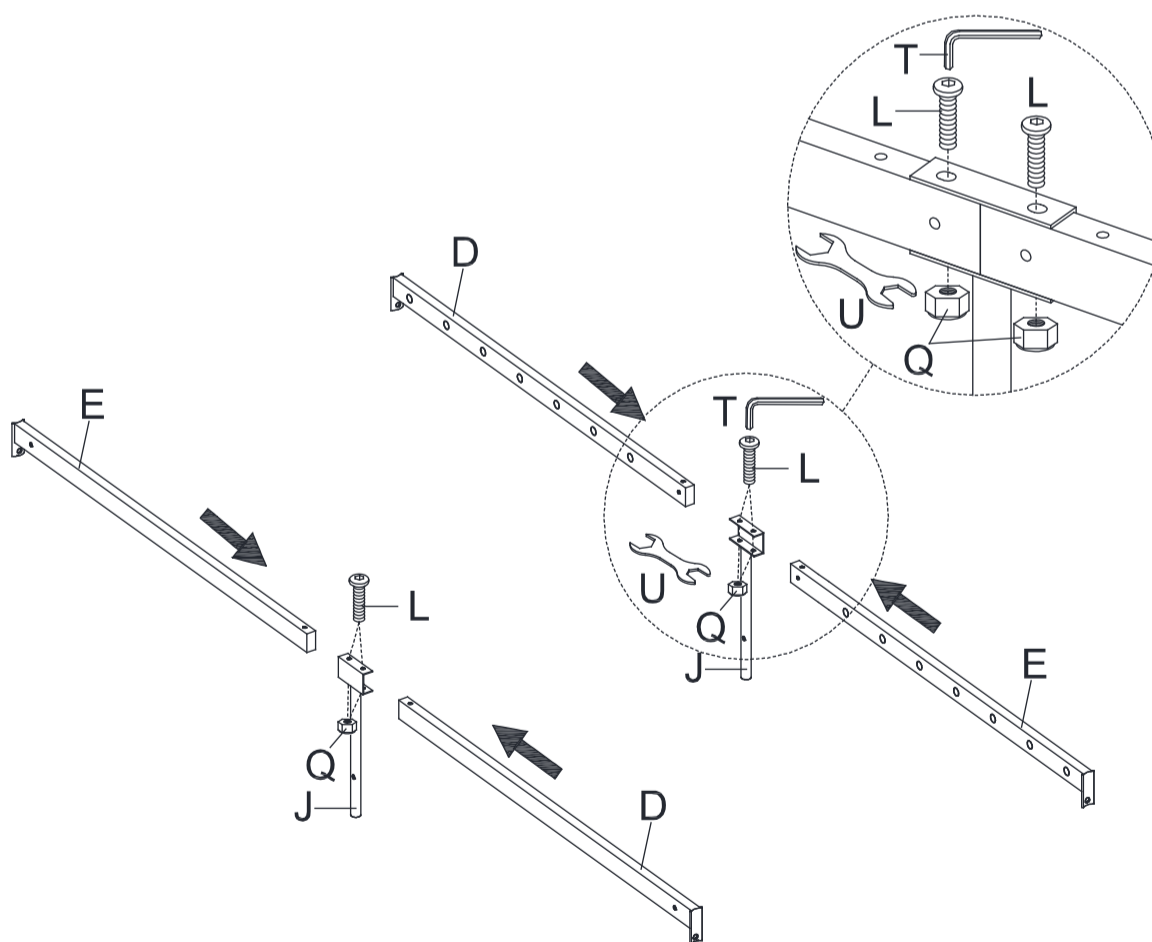

Attach D*1, E*1 to J*1 with bolts L*2, nut Q*2, and then tighten them with Spanner U, Allen Key T. The other side do the same.

