

INSTALLATION MANUAL

HIGH QUALITY MEDICINE CABINET

BUILD FOR LUXURY LIFE SPACE

HARDWARE AND TOOLS

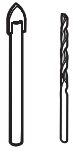

1/4" & 1/8" Drill Bits



Pencil



Level

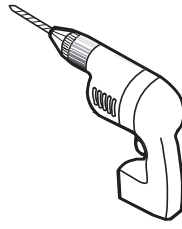

Power Drill



Mallet



Tape Measure

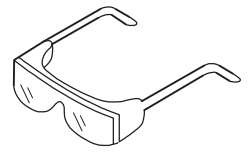

Safety Goggles

PRODUCT FUNCTION INSTRUCTIONS



Touch key to turn on/off defogging function. When defogger is on, the button should be in blue color. The anti-fog function can only be used after 5 minutes of turning on, and will automatically cancel after 60 minutes of standby. If extended use is required, it must be re-enabled.



After power on, the button shows blue and it is in waiting state



The lighting color temperature will be changes with each short press

Click the light button to turn on and the color changes to white
Click again to change the light color
Click the fourth time to turn off the light



LED



Long press to adjust the brightness

Long press to make the light gradually dims
Long press again and the light gradually brightens

When you adjust to your favorite color temperature, long press the button, you can adjust the brightness of the color temperature, click again, you can adjust to another color temperature.



Memory function: The medicine cabinet will record the color temperature and brightness of your last use. When you turn off the color and brightness after using it last time, when you use it again, it will return to the state you used last time, no need to adjust it again and waste time every time.

Connect the wire to Junction Box inside the wall.

The electric wire comes through the access hole on the top of the cabinet, exact location of access hole varies depending on the product models. Please refer to the actual product for the exact location.

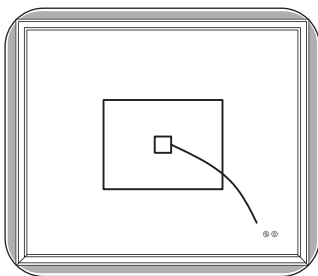

Make connection with Junction box

Neutral to white.
Line to black.
Ground to green.

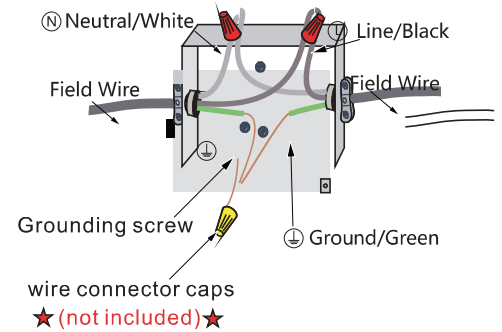
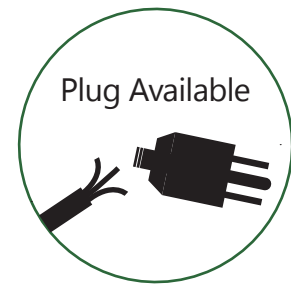
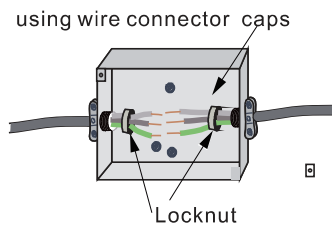

ALL WIRING SHOULD BE DONE BY A QUALIFIED LICENCED ELECTRICIAN.

WARNING: Shut off power before wiring the cabinet.

Requires 120 VAC 20 Amp GFI protected Circuit.

GROUNDING INSTRUCTIONS:

CAUTION: This product must be connected to a grounded metal permanent wiring system or an equipment-grounding conductor must be run with the circuit conductors and connected to the equipment grounding terminal or lead on the product.

WARNING: An Electrical option cabinet must be wired to a 20 Amp GFI (Ground Fault Interrupter) protected circuit when used in bathrooms and all other locations required by the National Electric Code.

Step 1

Use the tape measure the height, and draw the horizontal, line and the vertical line of the wash-basin. Measure the distance of the mirror hole, and mark the hole place on the wall.

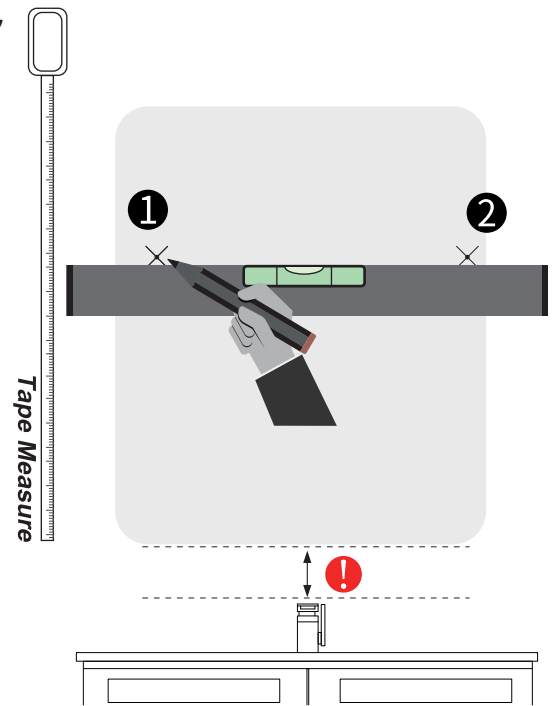
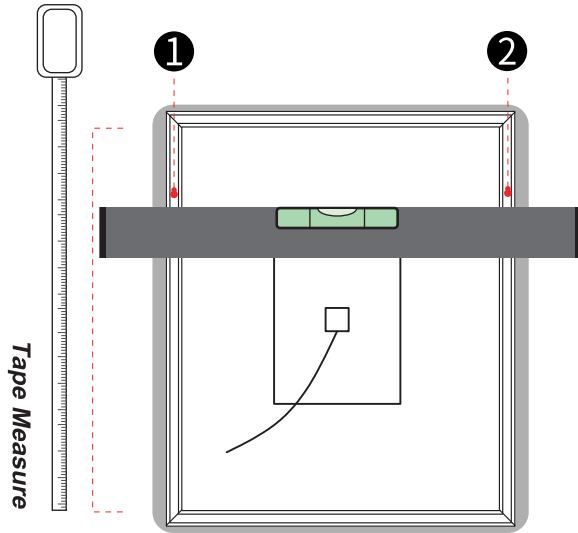

NOTE: Please hang the mirror a few inches above the highest part of the faucet.

Step 2

Drill and insert the Wall Anchor. Drive in the screw cross the bottom support.

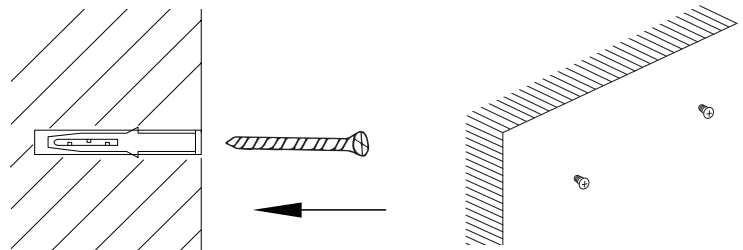

Step 3

Align the holes of the mirror with the screws and hang them to complete the installation.

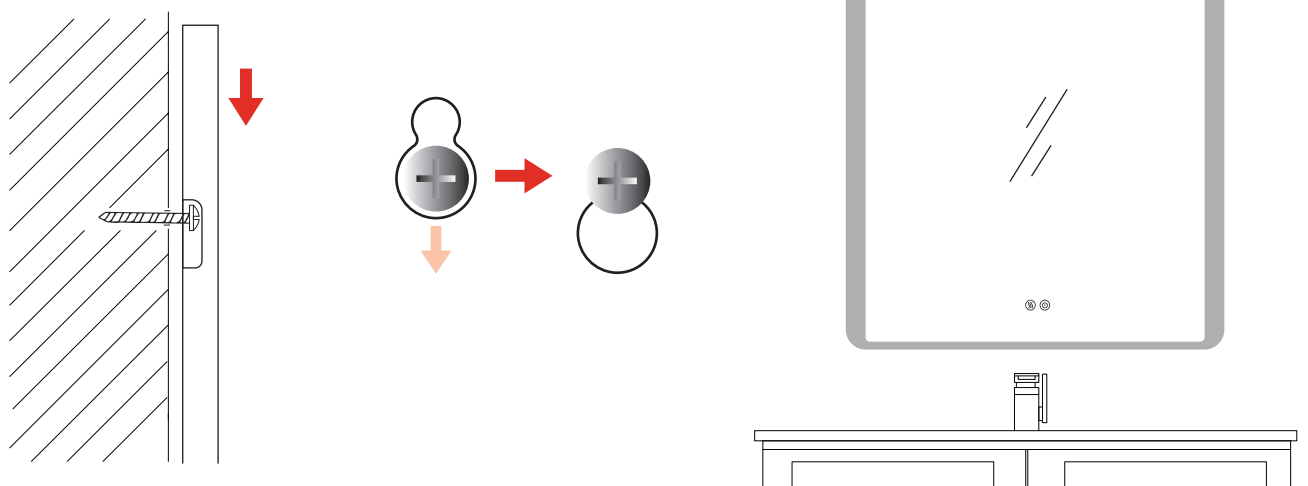

Step 1

Use the tape measure the height, and draw the horizontal, line and the vertical line of the wash-basin. Measure the distance of the mirror hole, and mark the hole place on the wall.

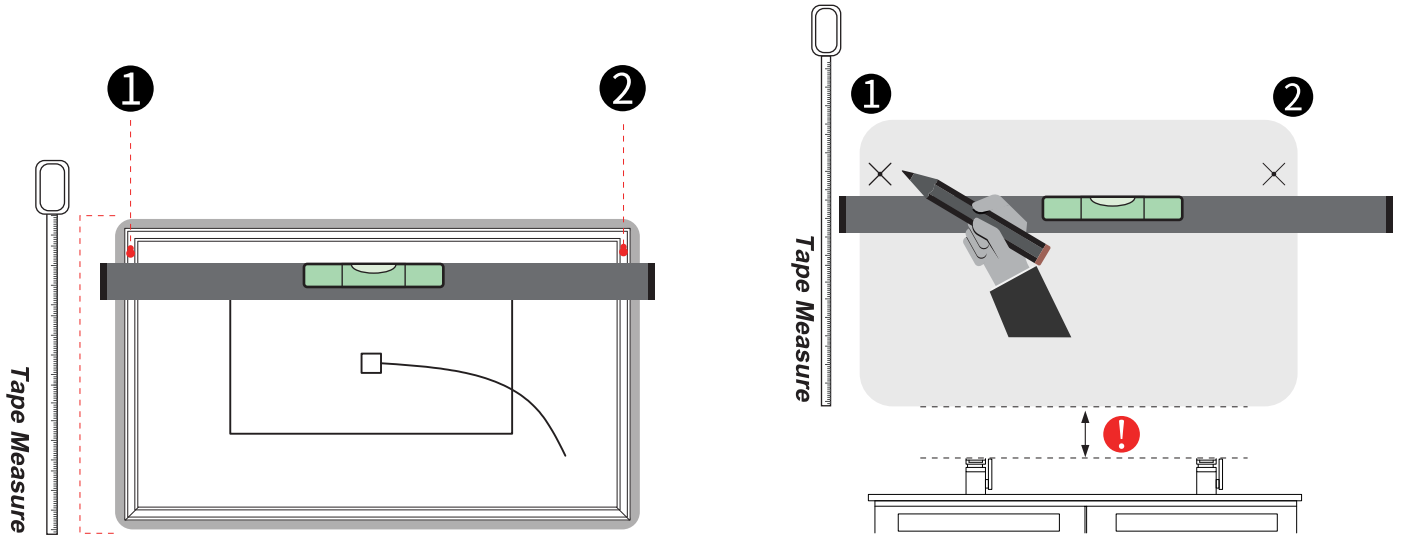

NOTE: Please hang the mirror a few inches above the highest part of the faucet.

Step 2

Drill and insert the Wall Anchor. Drive in the screw across the bottom support.

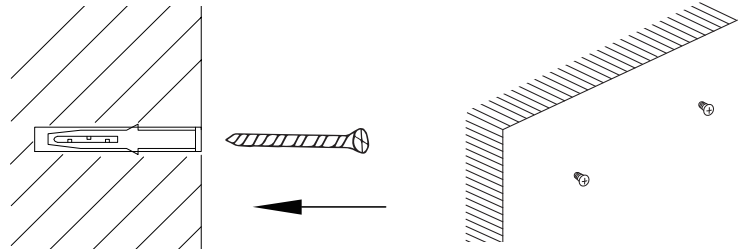

Step 3

Align the holes of the mirror with the screws and hang them to complete the installation.

