

DIMENSIONS

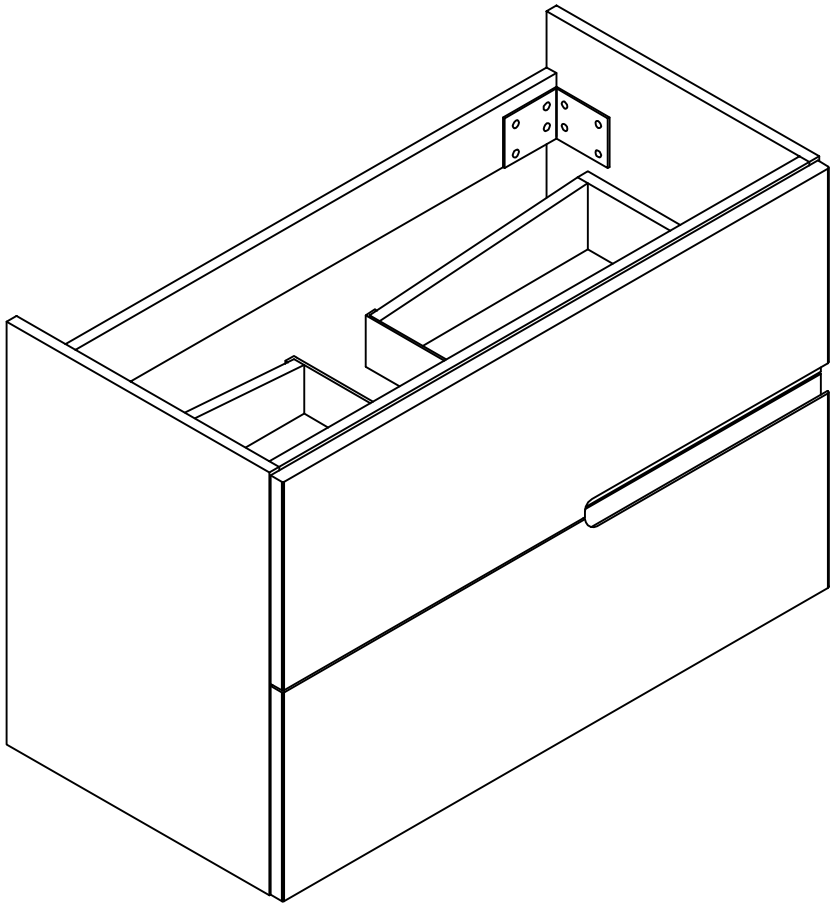

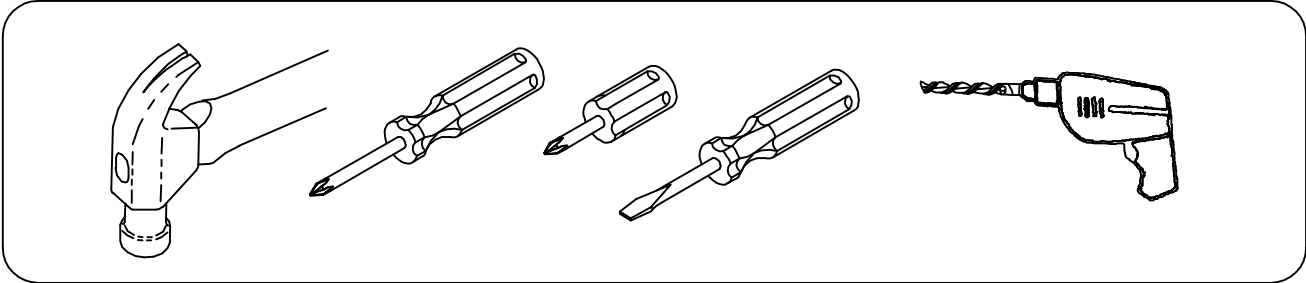





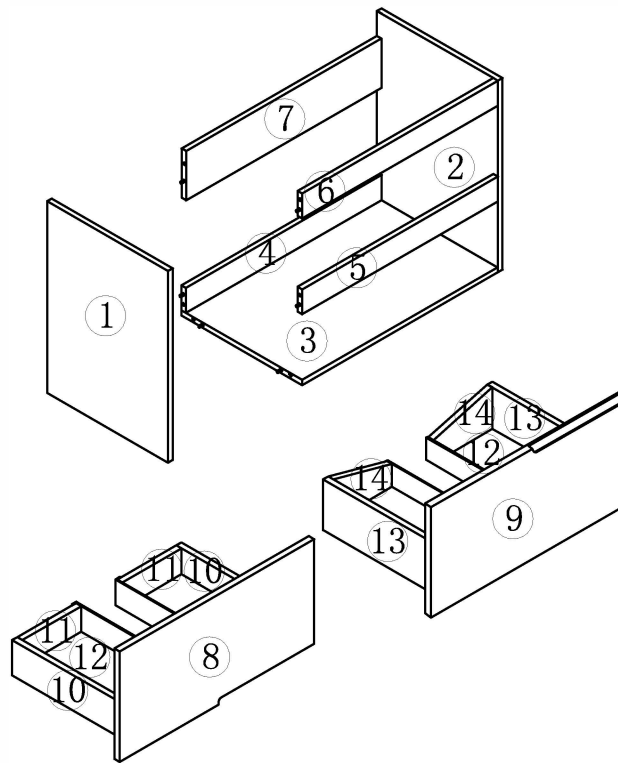









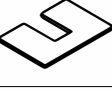



YOU MAY NEED (NOT SUPPLY)



ASSEMBLY DIAGRAM



| PARTS LIST | | | | | |
|------------|--|-----|----|--|-----|
| NO | DESCRIPTION | QTY | NO | DESCRIPTION | QTY |
| ① | Left side panel  | 1 | ⑧ | Upper drawer front panel  | 1 |
| ② | Right side panel  | 1 | ⑨ | Lower drawer front panel  | 1 |
| ③ | Bottom panel  | 1 | ⑩ | Upper drawer side panel  | 2 |
| ④ | Lower back panel  | 1 | ⑪ | Upper drawer rear panel  | 2 |
| ⑤ | Front middle panel  | 1 | ⑫ | Drawers bottom panel  | 2 |
| ⑥ | Long front panel  | 1 | ⑬ | Lower drawer side panel  | 2 |
| ⑦ | Upper back panel  | 1 | ⑭ | Lower drawer rear panel  | 2 |

| PARTS LIST | | | | | |
|--|---|-----|----|---|-----|
| HARDWARE LIST | | | | | |
| NO | DESCRIPTION | QTY | NO | DESCRIPTION | QTY |
| A | Three-in-one eccentric wheel  | 40 | E | Drawer slides  | 4 |
| B | Three-in-one connecting rod  | 40 | F | 4*16mm screw  | 60 |
| C | Three-in-one sticker  | 40 | G | Drawer U-shaped plastic  | 2 |
| D | 8*40mm wood dowel pins  | 20 | H | White angle bracket  | 2 |
| CAUTION: Please confirm the parts list before installation | | | | | |

STEP 1

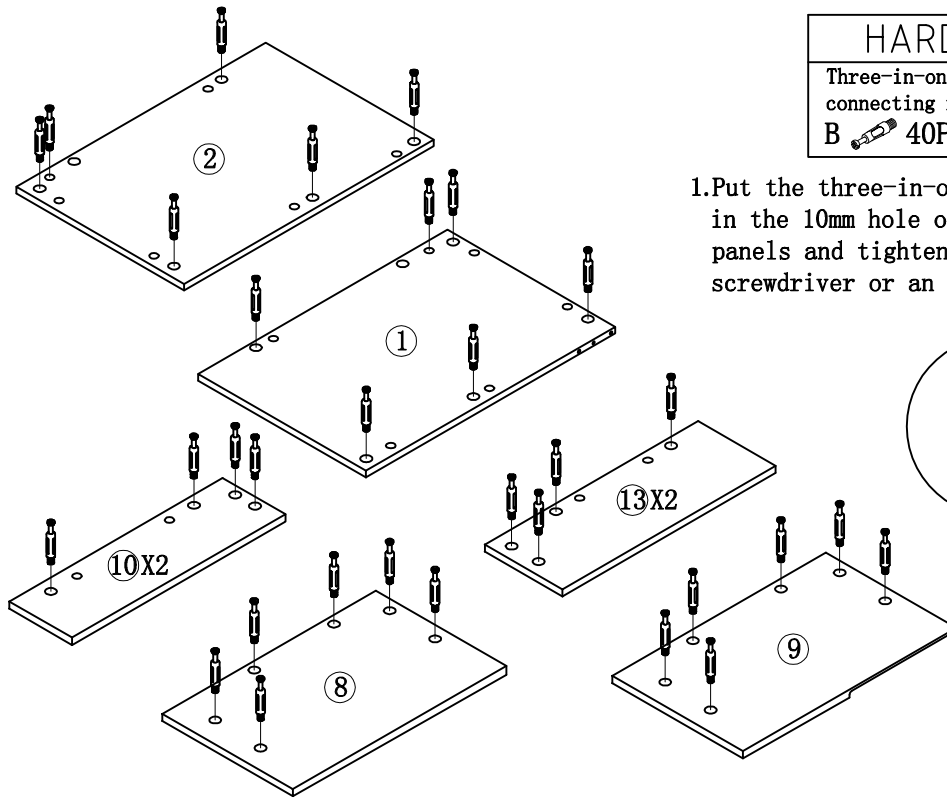

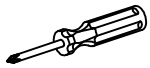
| HARDWARE LIST | |
|---|---|
| Three-in-one connecting rod B  40PCS |  |

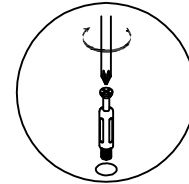

1. Put the three-in-one connecting rod in the 10mm hole of the following panels and tighten them with a cross screwdriver or an electric tool.

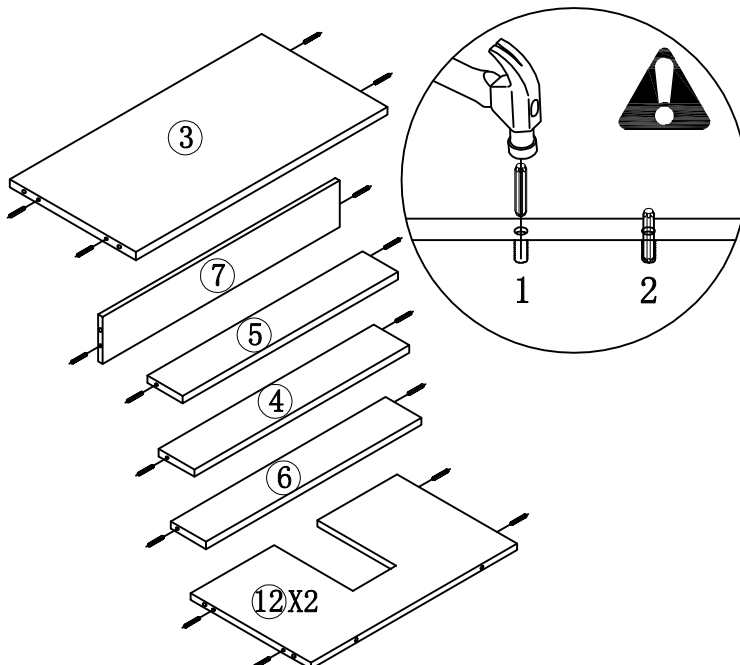

STEP 2





1. Strike the 8*40mm wood dowel pin into the 8mm hole of the above panels with an iron hammer. Please note that the hole of the three-in-one connecting rod should also be 8mm. The hole of the three-in-one connecting rod connects to the hole of 15mm three-in-one eccentric wheel.

| HARDWARE LIST | |
|--|---|
| 8*40mm wood dowel pins D  20PCS |  |

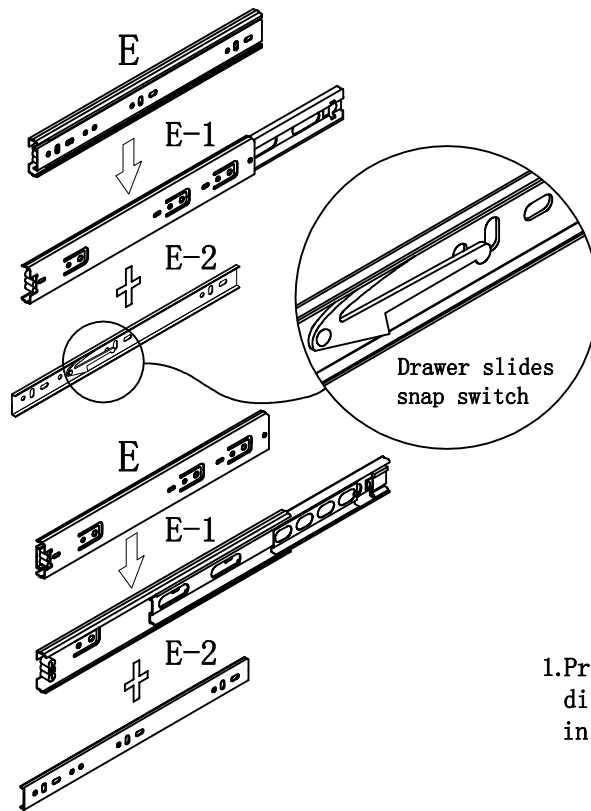
STEP 3







| HARDWARE LIST | |
|--|---|
| Drawer slides |  |
| E  4PCS | |

1. Press the slide snap switch, disassemble slide blocks and put them in a place properly for further use.

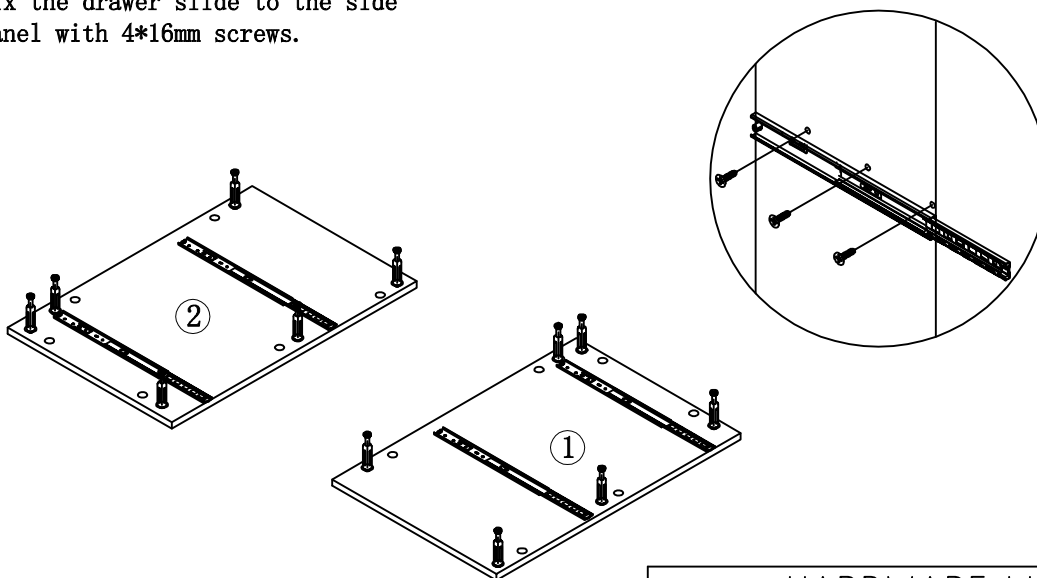
STEP 4

1. Fix the drawer slide to the side panel with 4*16mm screws.



| HARDWARE LIST | | |
|---|--|---|
| 4*16mm screw | Drawer slides |  |
| F  12PCS | E-1  4PCS | |

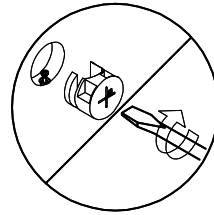
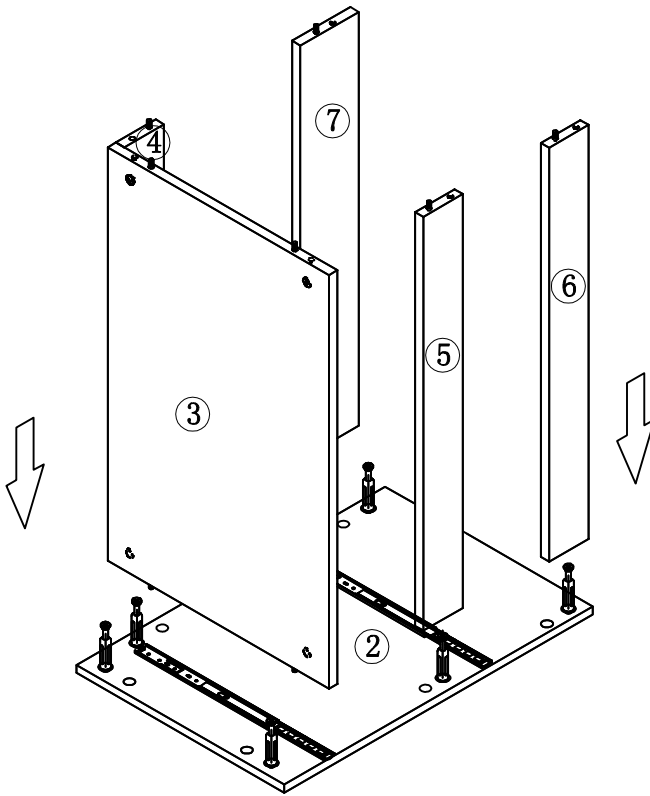

STEP 5

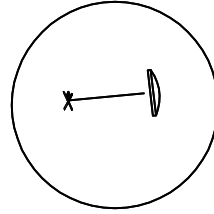

1. Connect No. 3-4-5-6-7 panel to No. 2 panel tightly with the three-in-one eccentric wheel.



2. Cover the mounting hole of the eccentric wheel with a three-in-one sticker.

| HARDWARE LIST | | |
|---|---|--|
| Three-in-one eccentric wheel A  6PCS | Three-in-one sticker C  6PCS |  |

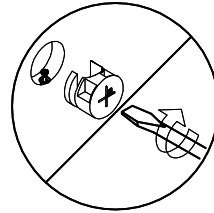
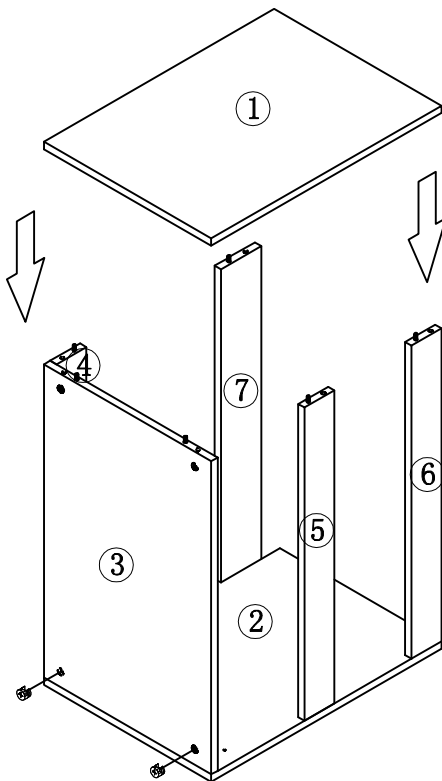

STEP 6

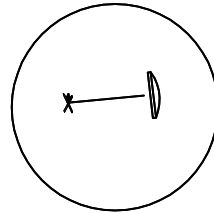

1. Connect No. 1 panel to No. 3-4-5-6-7 panel tightly with the three-in-one eccentric wheel.



2. Cover the mounting hole of the eccentric wheel with a three-in-one sticker.

| HARDWARE LIST | | |
|--|--|---|
| Three-in-one eccentric wheel A  6PCS | Three-in-one sticker C  6PCS |  |

STEP 7



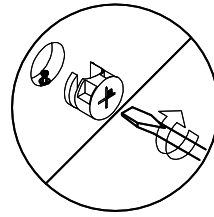
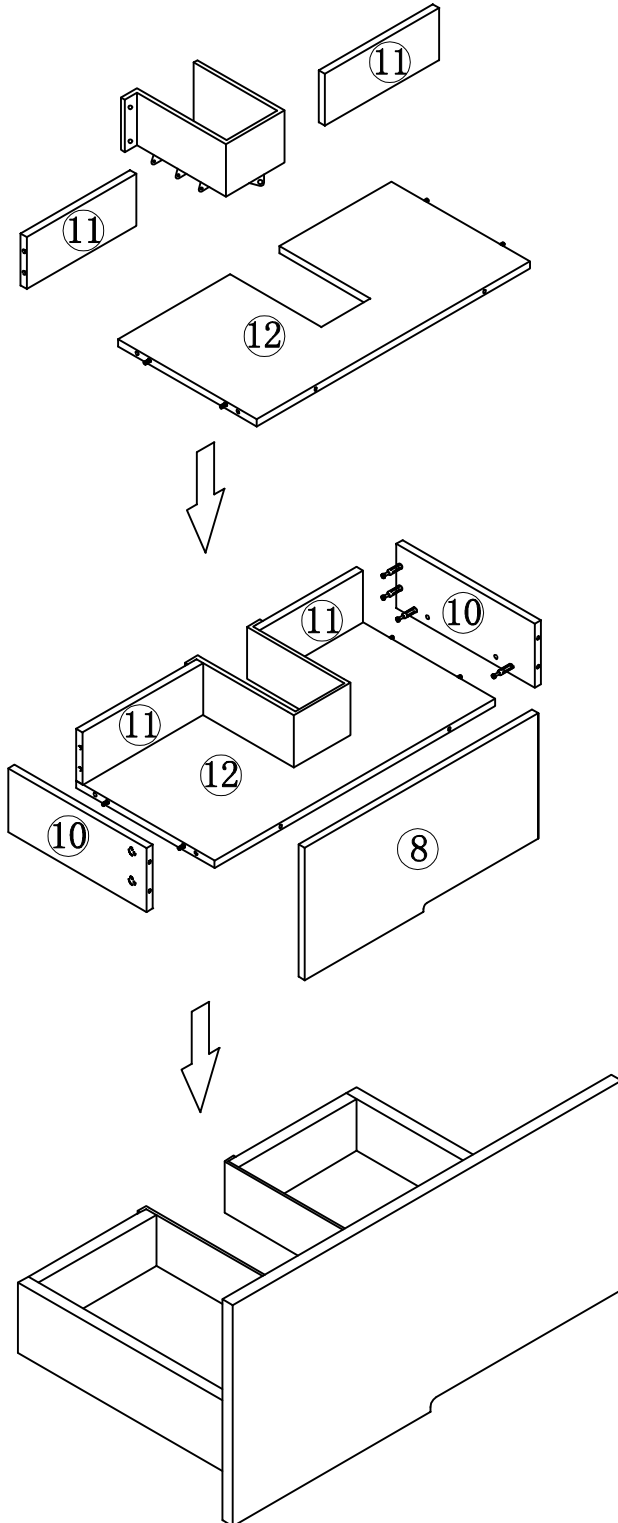

1. Install the Drawer U-shaped plastic storage box with 4*16mm screws.

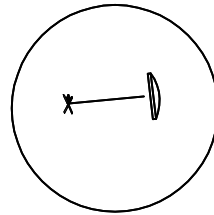

1. Install No. 8-10-11-12 panels with the three-in-one eccentric wheel tightly.

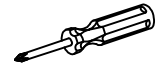

2. Cover the mounting hole of the eccentric wheel with a three-in-one sticker.

| HARDWARE LIST | | |
|---|---|---|
| Three-in-one eccentric wheel A  14PCS | Three-in-one sticker C  14PCS |  |
| Drawer U-shaped plastic G  1PCS | 4*16mm screw F  10PCS |  |

STEP 8



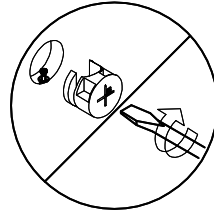
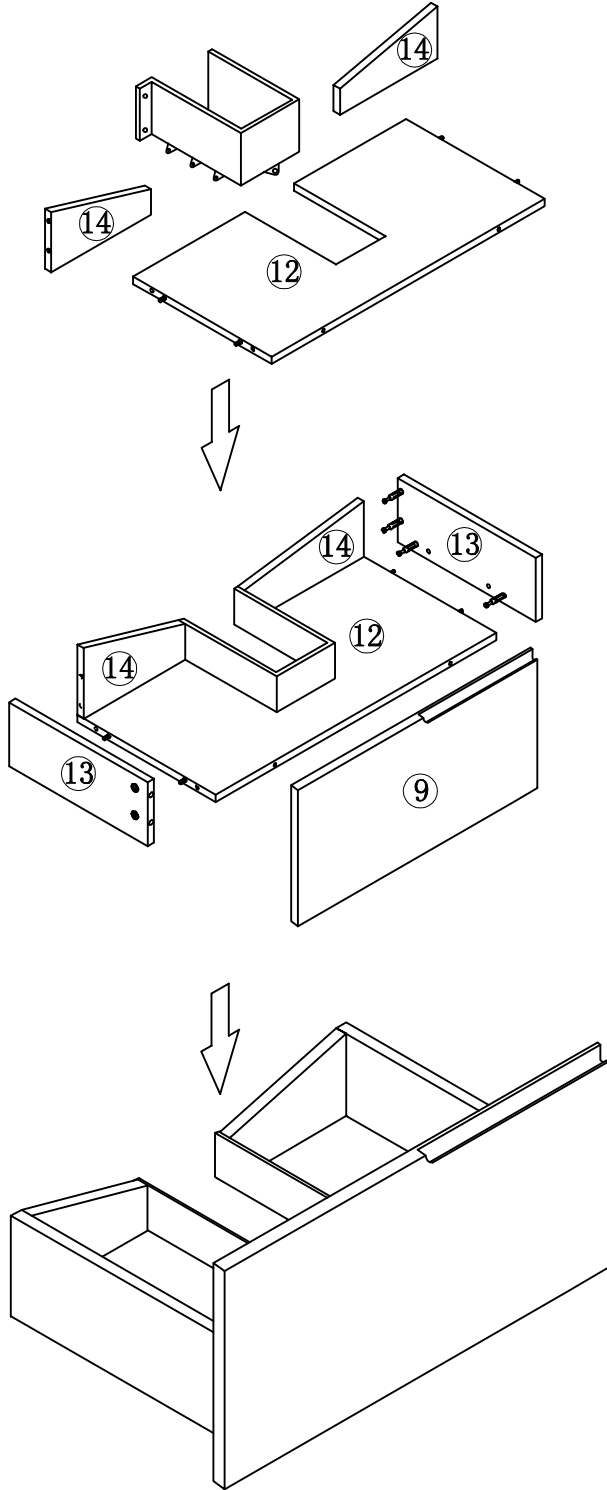

1. Install the Drawer U-shaped plastic with 4*16mm screws.

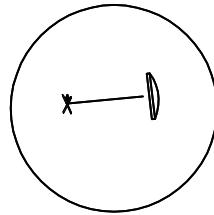

1. Install No. 9-12-13-14 panels with the three-in-one eccentric wheel tightly.



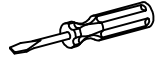

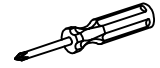
2. Cover the mounting hole of the eccentric wheel with a three-in-one sticker.

| HARDWARE LIST | | |
|---|---|---|
| Three-in-one eccentric wheel A  14PCS | Three-in-one sticker C  14PCS |  |
| Drawer U-shaped plastic G  1PCS | 4*16mm screw F  10PCS |  |

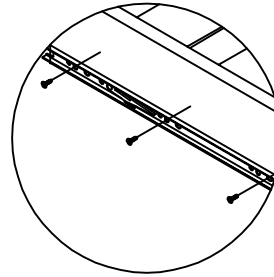
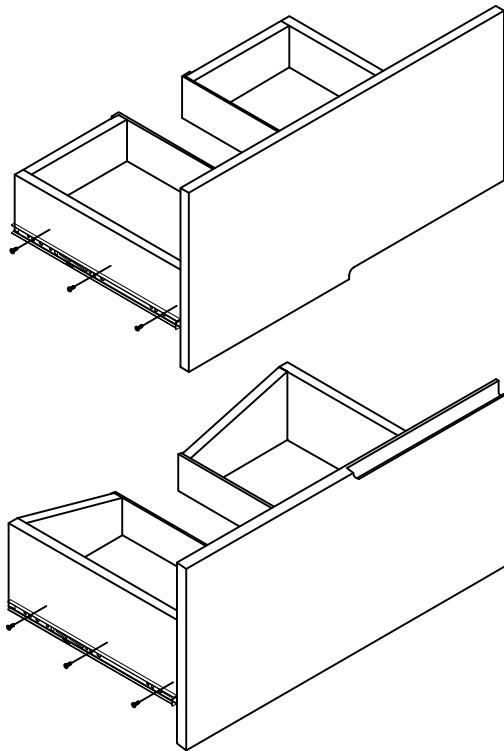
STEP 9

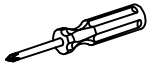

1.Lock the spare drawer slide block to the drawer.

| HARDWARE LIST | | |
|---|--|--|
| 4*16mm screw | Drawer slides |  |
| F  12PCS | E-2  4PCS | |

STEP 10

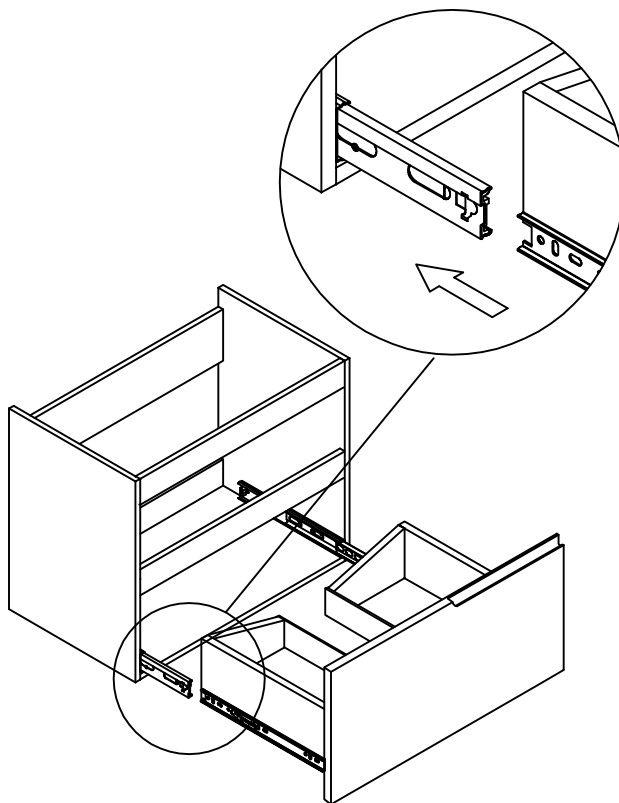

1.Align slide block with the trough on the guide rail, press the snap switch and press it forward to install the drawer.

STEP 11

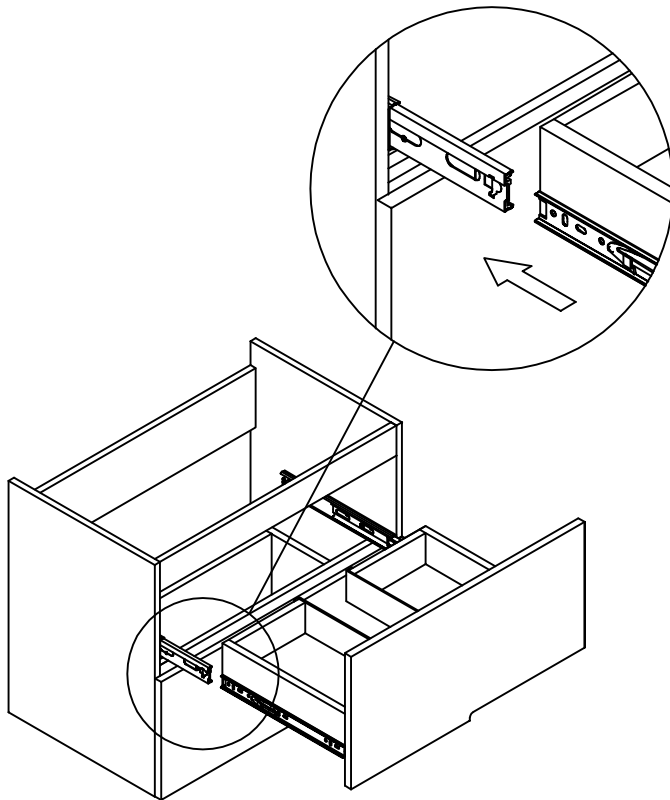

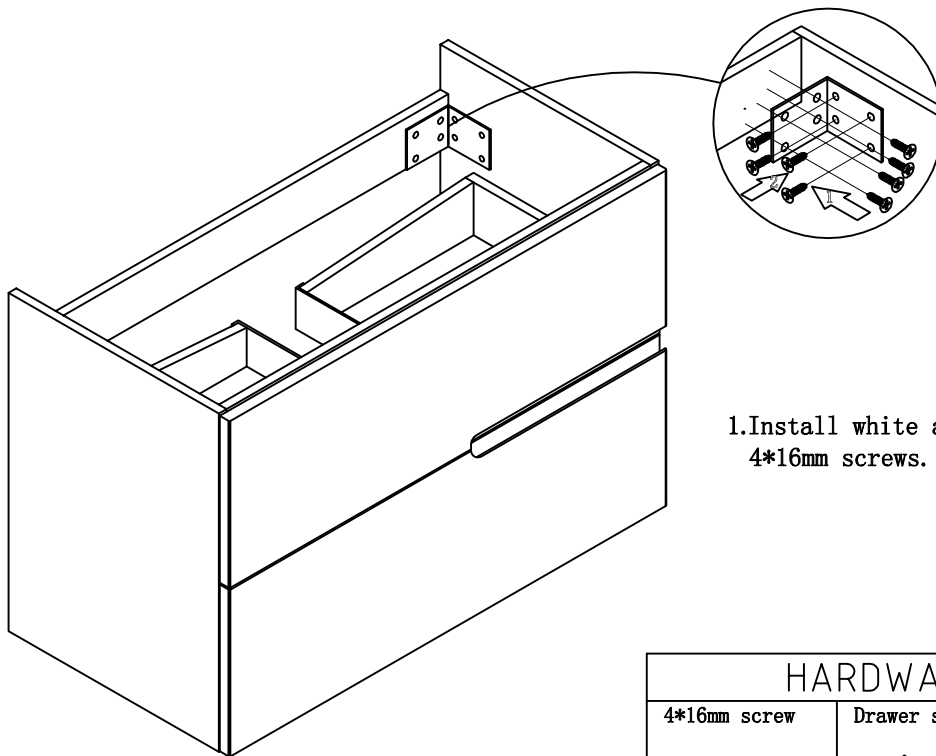

1.Align slide block with the trough on the guide rail, press the snap switch and press it forward to install the drawer.

STEP 12

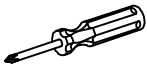

1.Install white angle bracket with 4*16mm screws.

| HARDWARE LIST | | |
|---|--|---|
| 4*16mm screw | Drawer slides |  |
| F  16PCS | H  2PCS | |