

HANGING INSTRUCTION

RECOMMENDED TOOLS



Drill



Tape Measure



Hammer



Level



Pencil

HARDWARE SUPPLIED



Blue Anchors



Screws

MOUNT ART TO DRYWALL SURFACE AS FOLLOWS:

1. Mark wall anchor locations; make certain the marks are level and spaced apart as necessary

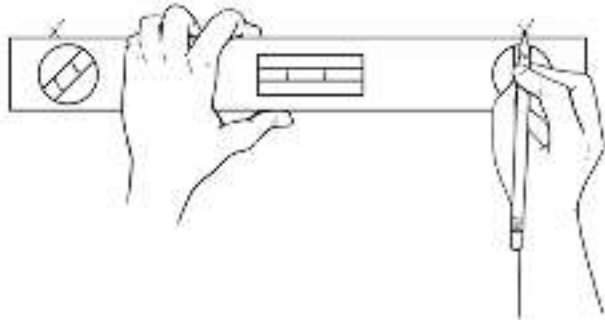

2. Drill holes, 3/16" diameter through drywall

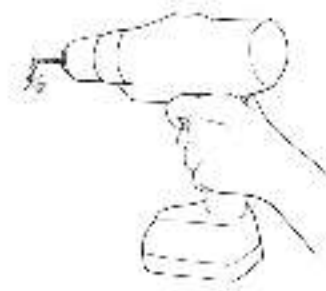

3. Tap the supplied drywall anchors firmly into drilled holes

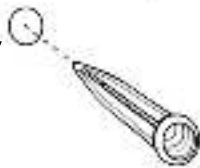

4. Carefully drive the drywall screws into the anchors, leaving the screw heading protruding from the wall surface as follows:

Thin Bar Frames 3/4"

Thick Bar Frames 1 1/2"

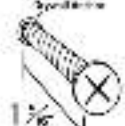

5. Hang your art and enjoy!

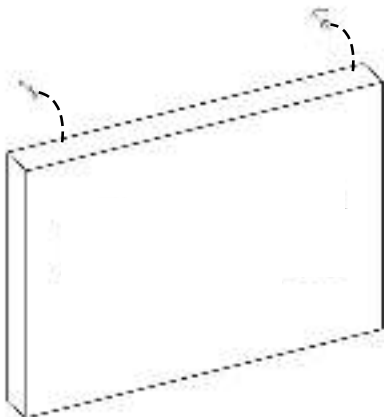

Quality Guarantee:

We are passionate about the presentation of every piece of art. Our team is picky about only using premium images, materials, and packaging solutions that ensure great art is delivered safely to your doorstep. If you find any defects in the condition or quality of your piece of art, we will exchange the item free of charge.

CARE GUIDE

RECOMMENDED TOOLS

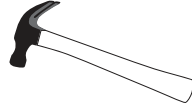

Hammer

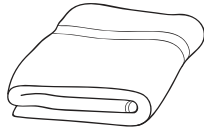

Towel



Ice cube

FIXING LOOSE CANVAS

In the corners of the canvas on the back, you will notice two wedges in each corner that allows you to adjust the tension by slightly tapping on them with a hammer.

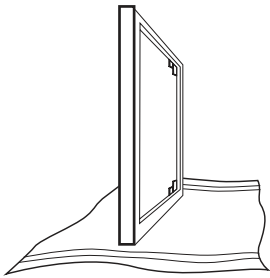

Stand piece of art upright on a hard surface and place a piece of cloth between the art and the surface to protect both.

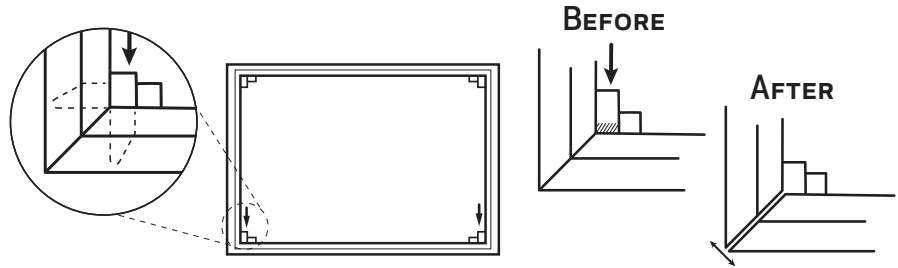

Tap down on the stretcher wedges with a hammer where the arrows point. Rotate canvas to always be tapping downward towards the hard surface. **Tap until you see the frame begin to split further apart.** Repeat process until canvas is pulled taut.

FIXING INDENTATIONS & CREASES

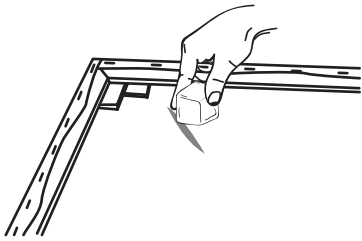

On the back of the canvas, rub the piece of ice directly to the crease for about 30-60 seconds.

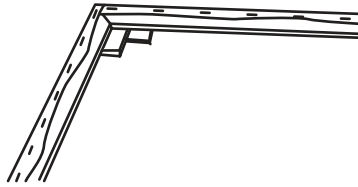

Let dry for 15-20 minutes and the crease or indentation should go away. Avoid over saturating, or canvas may need to dry for a while longer.

FIXING WARPED FRAME

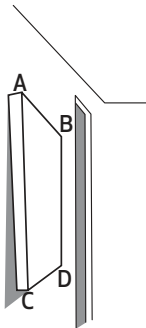

Warped frames can be easily fixed by bending them back.

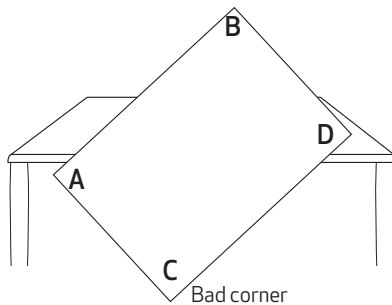

Place the art along a table's edge as shown. Place your hands on the corner that was coming away from the wall and its opposite corner. Gently push down on the corners to stretch the canvas diagonal. Hang your art piece on the wall and test. If still coming away from the wall, repeat steps.

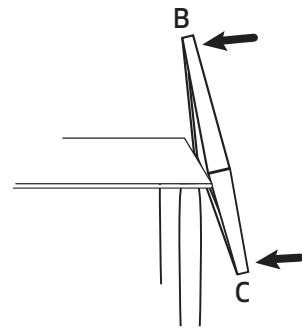

NOTE: It is normal to hear the wood slightly splintering.